



# AIR CIRCUIT BREAKER



# INSTRUCTIONS

# Contents

<b>Specification</b>	<b>1</b>
<b>1. Introduction</b>	<b>3</b>
1.1 Purposes	3
1.2 Type designation	3
1.3 Classification	3
1.4 Conditions of Use	3
<b>2. Structure specifications</b>	<b>4</b>
<b>3. Intelligent controller</b>	<b>5</b>
3.1 Function comparison table	6
3.2 Protection Parameter	6
3.2.1 Overload Long time delay protection characteristics	6
3.2.2 Short-circuit short time delay protection characteristics	7
3.2.3 Short-circuit instantaneous protection characteristics	7
3.2.4. Unsymmetrical Ground fault / Earth leakage protection characteristics	8
3.2.5 Load monitoring protection characteristics	9
3.2.6 Open Phase protection characteristics	10
3.2.7 Other functions	10
<b>4. Characteristics curves</b>	<b>13</b>
4.1 Overload long time delay	13
4.2 Short circuit short time delay	14
4.3 Short circuit instantaneous	14
4.4 Ground fault	15
4.5 Earth leakage	15
<b>5. Accessories</b>	<b>16</b>
5.1 Shunt-release, under-voltage release, Motor-driven, closing coil	16
5.2 Auxiliary contacts	16
5.3 Lock devices	17
5.4 Testing kit	19
<b>6. Wiring</b>	<b>19</b>
6.1 Control wire diagram	19
6.2 Secondary wire diagram	20
6.2.1 XSIC-A series intelligent controller	20
6.2.2 XSIC-P series intelligent controller	20
6.2.3 ATS Wiring Diagram	21
<b>7. Outline and installation dimensions</b>	<b>22</b>
7.1 Draw-out type outline	22
7.2 Fixed type outline	28
7.3 Compartment Hole Drilling Dimensions and Mounting Hole Distance	33
7.4 Busbar Support	34
<b>8. Mounting, usage and maintenance</b>	<b>35</b>
8.1 Mounting	35
8.2 Intelligent Controller Usage	35
8.2.1 Panel Schematic Diagram	35
8.2.2 HMI Instruction	36
8.2.3 Setting, query and testing methods and system clock setup	38
8.3 Instruction of draw in/out of ACB main body	43
8.4 Maintenance	43
<b>9. Commonly Observed Faults and Trouble-shooting</b>	<b>44</b>

## Specifications



Frame Size		2000AF					2500AF			
Model		BW-2000					BWA-2500			
Rated Current, In		630	800	1000	1250	1600	2000	400 / 630 / 800 / 1000 / 1250 / 1600 / 2000		2500
Pole		3P / 4P					3P / 4P			
Frequency (Hz)		50 / 60HZ					50/60HZ			
Rated Voltage, Ue		AC690V					AC 400/415/690V			
Rated Impulse Withstand Voltage, Uimp		12kV					12kV			
Insulation Voltage, Ui		AC1000V					AC1000V			
Rated Current of Neutral (%)		100%In					100%In			
Breaking Capacity	Model		HS		HN		H			
	Icu / Ics (kA)	690V	50 / 50		55 / 55		65 / 65			
		380/400/415V	80 / 50		85 / 85		85 / 85			
		240V	80 / 50		85 / 85		—			
	Icw (kA) 1sec	400/415V	50		65		85			
		690V	50		55		65			
Operating time (ms)	Max. total breaking time		40				40			
	Max. closing time		80				80			
Endurance	Mechanical	With maintenance	20,000				15000			
		Without maintenance	10,000				30000			
	Electrical	With maintenance	15,000				8000			
		Without maintenance	8,000				6000			
Dimension HxWxD (mm)	Fixed Type	3P	402x362x332				397x365x364			
		4P	402x455x332				397x460x364			
	Drawout Type	3P	430x375x421				435x405x448.5	435x405x473		
		4P	430x470x421				435x500x448.5	435x500x473		
Weight 3P/4P (kg)	Fixed Type		45.4 / 60.8	48.2 / 63.6	51 / 66.4		—			
	Drawout Type		78.85 / 94.6	77.95 / 98.5	84.75 / 107		83.5 / 108.5			

Note: Icu/Ics/Icw for HS type only labeled 400V and 690V on the name plate, other voltage are for reference.



3200AF			4000AF		6300AF		6300	
BW-3200			BW-4000		BW-6300		BW-6300HN	
2000	2500	3200	4000		5000	6300	4000, 5000	6300
3P / 4P			3P / 4P		3P / 4P		3P / 4P	
50 / 60HZ			50 / 60HZ		50 / 60HZ		50 / 60HZ	
AC690V			AC690V		AC690V		AC380 / 400 / 415, AC690	
12kV			12kV		12kV		12kV	
AC1000V			AC1000V		AC1000V		AC1000V	
100%In			100%In		100%In		100%In	
HS	HN		HS	HN	HS		HN	
65 / 50	65 / 65		65 / 50	65 / 65	85 / 85		85	
100 / 65	100 / 100		100 / 65	100 / 100	120 / 100		120	
100 / 65	100 / 100		100 / 65	100 / 100	120 / 100		—	
65	85		65	85	100		100	
65	65		65	75	85		85	
40			40		40	40	40	
80			80		80	80	80	
20,000			20,000		10,000	10,000	6500	
10,000			10,000		2,500	2,500	13000	
13,000			12,000		2,000	2,000	4000	
6,500			6,000		500	500	4000	
402x422x332			402 x 422 x 377		—	—	402 x 800 x 377	
402x537x332			402 x 537 x 377		—	—	402 x 915 x 377	
430x435x421			430 x 465 x 466		435 x 842 x 505	435 x 960 x 505	435 x 842 x 495	435 x 958 x 495
430x550x421			430 x 580 x 466		435 x 956 x 492		435 x 958 x 495	435 x 958 x 495
61.2 / 81.6	67.2 / 87.6		61.2 / 81.6		—	—	130 / 145	140 / 156
87.85 / 110.6	107.35 / 136		107.35 / 136		230 / 290	230 / 290	83.5 / 108.5	

## 1. Introduction

### 1.1 Purposes

The rated voltages of BW series air circuit breakers (referred to as circuit breakers) are rated voltage AC400V, 690V, 50/60HZ. The rated current is from 630 to 6300A. It's used for distributing power and protecting circuits in the electrical distribution system is protected from overloading, voltage shortage, short circuit, ground fault, and other hazardous faults. The circuit breaker has multiple intelligent protection functions available for selection. The protective actions have a high precision for preventing unnecessary power failure, closing power supply much more reliable.

### 1.2 Type Designation

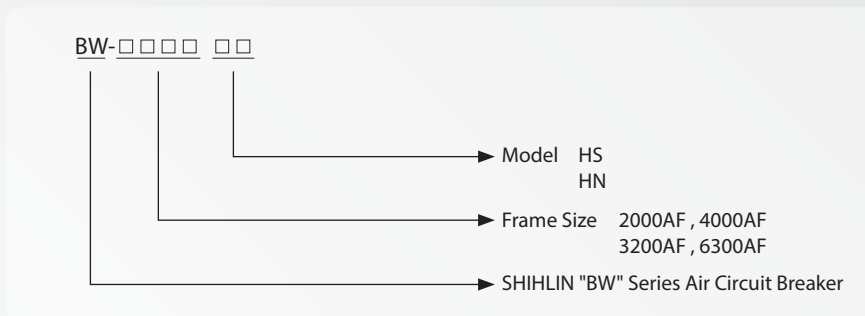

### 1.3 Classification

- Mounting type: Draw out type, fixed type
- Operation mode: Electric and manual operation
- Number of poles: 3 and 4
- Tripping categories: Intelligent controller, under-voltage instantaneous (or delay) release, and shunt release
- Intelligent controller can be divided into two types based on functions: XSIC-A and XSIC-P
- Under-voltage release has instantaneous and delay types.

### 1.4 Conditions of Use

- Ambient temperature:  $-5^{\circ}\text{C}\sim 40^{\circ}\text{C}$ 
  - Note: (1) If the minimum working condition is  $-10^{\circ}\text{C}$  or  $-25^{\circ}\text{C}$ , please notify us when ordering the product.
  - (2) If the maximum working condition exceeds  $+40^{\circ}\text{C}$  or the minimum is less than  $-25^{\circ}\text{C}$ , please discuss with the sales representative.
- The product cannot be installed at places above 2000 altitude.
- Atmospheric conditions: Relative humidity could not exceed 50% when the surrounding temperature is  $+40^{\circ}\text{C}$ . For lower temperature, the relative humidity can be higher. The average maximum relative humidity for the month with the highest humidity is 90%, and the average lowest temperature of that month is  $+25^{\circ}\text{C}$ . Please consider the possibility of frosting on the surface of the product due to temperature change.
- Pollution level: 3
- Mounting categories: For circuit breakers with rated voltage 690V or below, under-voltage release coils and power transformer level 1 coils, the mounting type is IV. For auxiliary circuits and control circuits, the mounting type is III.
- Mounting conditions: Consult this manual for circuit breaker installation.

## 2. Structure Specifications

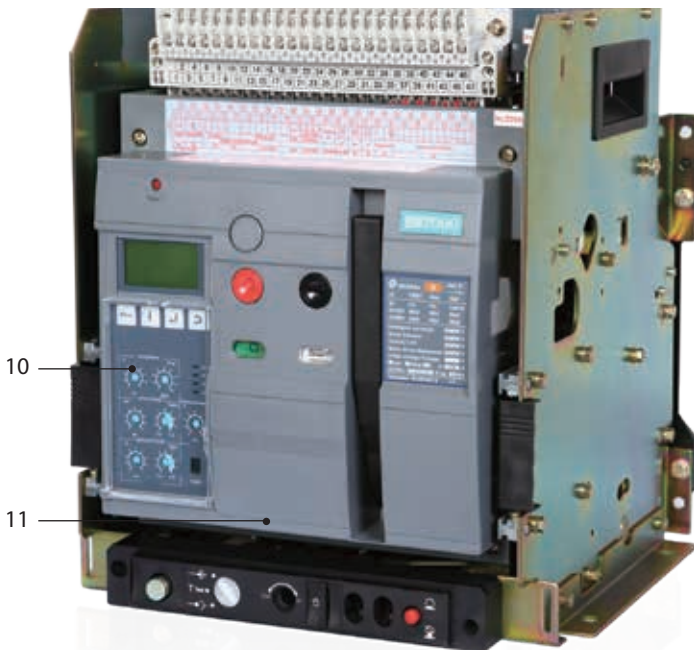

1. Secondary circuit terminal (Fixed)
2. Cradle
3. Shutter
4. Handle
5. Secondary circuit terminal (movable)
6. Auxiliary contacts
7. Shunt release
8. Closing coil
9. Operation mechanism
10. Intelligent controller
11. Panel
12. Motor driven



### 3. Intelligent Controller

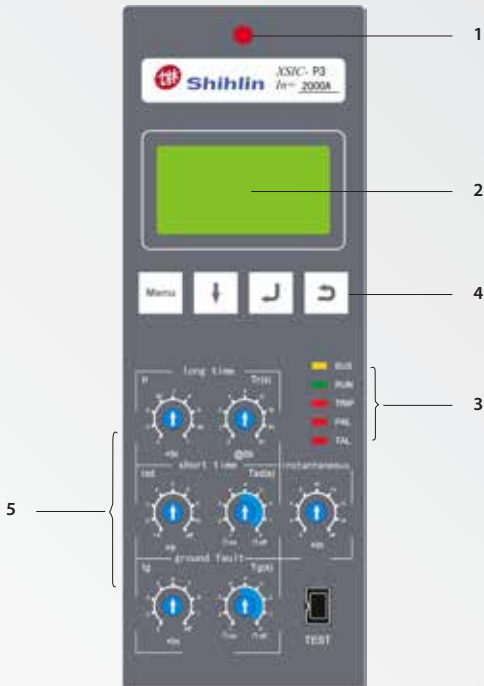

1. Reset button
2. LCD display
3. LED status indicator
4. Function buttons
5. Rotary protection setting

- Overload protection
  - Long time delay
  - Thermal function
- Idmtl long-time protection setting (EIT, DT ,SIT, VIT, HVF curve)
- Short circuit protection
  - Short time delay
  - $I^2t$  on/off optional (for STD)
- Ground fault protection
  - $I^2t$  on/off optional (for GFT)
- Earth leakage protection (Option)
- Neutral wire protection
  - 3 Pole: No protection
  - 4 Pole: 50 %, 100 % (x  $I_r$ ,  $I_{sd}$ )
- Current open-phase protection
- Measurement and display \*
  - 3 phase current/voltage
- Fault recording
  - Record up to 10 fault information about fault type, fault phase, fault value, occurrence time of fault.
- Field test
  - Simulation of long time, short time, instantaneous, Ground fault
- Pre-trip alarm
  - Prevent unnecessary over load trip according to  $I_r$ .
  - when the current exceeds the pickup threshold (equal to 105% of the  $I_r$  current setting ), the PAL LED on
- Communication : RS-485/Modbus-RTU \*
- 4a DO (digital output)
  - Contact specification

Note: \* Only for XSIC-P type

Rating	Nominal switching capacity	2A 250VAC
	Max. switching power (resistive load)	500VA
	Max. switching voltage	250VAC
	Max. switching current	2A
	Max. switching capacity (reference value)	2A 30VDC

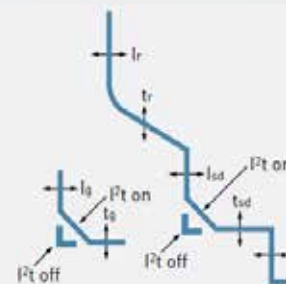

	Current setting(A)	$I_r = I_n \times \dots$	0.4	0.5	0.6	0.65	0.7	0.8	0.9	0.95	1	
	Long time	tripping between 1.05 and 1.20 $I_r$										
Time delay (sec) Accuracy: $\pm 20\%$		tsd	tr at (1.5 $\times I_r$ )	14	28	56	112	224	336	448	560	672
			tr at (2.0 $\times I_r$ )	14	11.7	23.3	46.7	93.3	140	187	233	280
			tr at (6.0 $\times I_r$ )	0.5	1	2	4	8	12	16	20	24
			tr at (7.2 $\times I_r$ )	0.5	0.69	1.38	2.75	5.51	8.26	11	13.8	16.5
Thermal memory	30min											
Short time	Current setting (A) Accuracy: $\pm 10\%$	$I_{sd} = I_r \times \dots$	1.5	2	3	4	5	6	8	10	OFF	
	Time delay (s) at 10 $\times I_r$	tsd	$I^2t$ off	0	0.1	0.2	0.3	0.4				
			$I^2t$ on		0.1	0.2	0.3	0.4				
		$(I^2t \text{ off})$	Min. trip time (ms)	30	70	170	270	360				
			Max. trip time (ms)	90	130	230	330	440				
Thermal memory (s)	15min											
Instantaneous	Current setting (A) Accuracy: $\pm 15\%$	$I_i = I_n \times \dots$	2	4	6	8	10	11	12	15	OFF	
	Trip time	$\leq 60ms$										
Ground fault (Option)	Pick-up (A) Accuracy: $\pm 10\%$	$I_g = I_n \times \dots$	0.2	0.3	0.4	0.5	0.6	0.7	0.8	1	OFF	
	Time delay (s) at 1 $\times I_n$	tg	$I^2t$ off	0	0.1	0.2	0.3	0.4				
			$I^2t$ on		0.1	0.2	0.3	0.4				
		$(I^2t \text{ off})$	Min. trip time (ms)	30	70	170	270	360				
			Max. trip time (ms)	90	130	230	330	440				
Earth leakage (Option)	Current setting (A) Accuracy: $-20 \sim 0\%$	$I_f$	0.5	1	2	3	5	7	10	20	30	
	Time delay (s) Accuracy: $\pm 20\% / \pm 30ms$	$T_f$	0.06	0.1	0.2	0.3	0.4	0.6	0.8	1	OFF	



### 3.1 Function Comparison Table

Controller		XSIC-A	XSIC-P
Protection function	Overload long-delay protection	■	■
	Short-circuit, short-delay protection	■	■
	Instantaneous protection	■	■
	Ground fault/Earth leakage protection/None (Optional)	■	■
	Open-phase protection	■	■
Other functions	Current measurement	■	■
	Current unbalance rate measurement	■	■
	Fault record functions	■	■
	Thermal memory functions	■	■
	MCR	■	■
	Contact wear indication	■	■
	programming port	■	■
	Temperature self-test	■	■
	Voltage measurement		■
	Load monitoring		■
	Four-set signal output		■
	Communication		■

### 3.2 Protection Parameter

#### 3.2.1 Overload Long time delay Protection Characteristics

Overload long time delay protection has inverse time characteristics.

When the N-phase protection setting coefficient is 50%, the setting value of N-phase protection would be 50% of phases A, B and C.

For example, if the overload long-delay setting current is 1600A, the overload setting current for the N phase will be 800A.

**Table 1.** Overload long time delay protection characteristics

EIT	0.5	1	2	4	8	12	16	20	24
1.5xlr	14	28	56	112	224	336	448	560	672
2xlr	5.83	11.67	23.33	46.67	93.3	140	186.7	233.3	280
6xlr	0.5	1	2	4	8	12	16	20	24
7.2xlr	0.5	0.69	1.38	2.75	5.51	8.26	11.01	13.77	16.52
≥10xlr	0.5	0.50	0.71	1.41	2.83	4.24	5.66	7.07	8.48
<b>DT</b>	<b>0.5</b>	<b>1</b>	<b>2</b>	<b>4</b>	<b>8</b>	<b>12</b>	<b>16</b>	<b>20</b>	<b>24</b>
1.5xlr	0.5	1	2	4	8	12	16	20	24
2xlr	0.5	1	2	4	8	12	16	20	24
6xlr	0.5	1	2	4	8	12	16	20	24
7.2xlr	0.5	1	2	4	8	12	16	20	24
≥10xlr	0.5	1	2	4	8	12	16	20	24
<b>SIT</b>	<b>0.5</b>	<b>1</b>	<b>2</b>	<b>4</b>	<b>8</b>	<b>12</b>	<b>16</b>	<b>20</b>	<b>24</b>
1.5xlr	3.23	6.45	12.90	25.81	51.61	77.42	103.23	129.04	154.84
2xlr	1.75	3.50	7.00	14.00	28.00	41.99	55.99	69.99	83.99
6xlr	0.5	1	2	4	8	12	16	20	24
7.2xlr	0.5	0.86	1.72	3.45	6.89	10.34	13.78	17.23	20.67
≥10xlr	0.5	0.67	1.34	2.68	5.36	8.05	10.73	13.41	16.09
<b>VIT</b>	<b>0.5</b>	<b>1</b>	<b>2</b>	<b>4</b>	<b>8</b>	<b>12</b>	<b>16</b>	<b>20</b>	<b>24</b>
1.5xlr	5	10	20	40	80	120	160	200	240
2xlr	2.5	5	10	20	40	60	80	100	120
6xlr	0.5	1	2	4	8	12	16	20	24
7.2xlr	0.5	0.81	1.61	3.23	6.45	9.68	12.90	16.13	19.35
≥10xlr	0.5	0.56	1.11	2.22	4.44	6.67	8.89	11.11	13.33
<b>HVF</b>	<b>0.5</b>	<b>1</b>	<b>2</b>	<b>4</b>	<b>8</b>	<b>12</b>	<b>16</b>	<b>20</b>	<b>24</b>
1.5xlr	159	319	638	1275	2550	3825	5100	6375	7650
2xlr	43.17	86.33	172.7	345.3	690.7	1036	1381	1727	2072
6xlr	0.5	1	2	4	8	12	16	20	24
7.2xlr	0.50	0.50	0.96	1.93	3.86	5.78	7.71	9.64	11.57
≥10xlr	0.50	0.50	0.50	0.52	1.04	1.55	2.07	2.59	3.11

**Note:** Five types of curves are available:

EIT: extremely inverse time curve (I<sup>2</sup>t) (default)

DT: definite time curve

SIT: standard inverse time curve (I<sup>0.5</sup>t)

VIT: very inverse time curve (It)

HVF: compatible with high-voltage fuses (I<sup>4</sup>t)

### 3.2.2 Short-circuit Short time delay Protection Characteristics

Intelligent controller's short-circuit Short time delay protection methods comprises inverse time protection and definite time restriction protection.

1. Inverse time protection: When the fault current exceeds the present setting current value but is smaller than the maximum setting short-circuit current ( $10I_r$ ), the controller will carry out protection according to the inverse time curve. When the fault current exceeds the maximum setting short-circuit current ( $10I_r$ ), the controller will carry out delay protection according to the present delay setting value.
2. Definite time protection: When the fault current exceeds the present setting short-circuit current, the controller will carry out delay protection according to the present delay setting value.
3. When overload long-delay setting time  $T_r = 0.5s$  or  $1s$ , the short-circuit protection enforced setting will be definite time protection (unadjustable).

Technical parameters of short-circuit short time delay protection characteristics are listed in Table 2.

Table 2. Short-circuit short time delay protection characteristics

I	Tsd								
	I <sup>2</sup> T ON				I <sup>2</sup> T OFF				
	0.1	0.2	0.3	0.4	0	0.1	0.2	0.3	0.4
1.5×I <sub>r</sub>	4.44	8.89	13.33	17.78	0.06	0.1	0.2	0.3	0.4
1.6×I <sub>r</sub>	3.91	7.81	11.72	15.63					
1.7×I <sub>r</sub>	3.46	6.92	10.38	13.84					
1.8×I <sub>r</sub>	3.09	6.17	9.26	12.35					
1.9×I <sub>r</sub>	2.77	5.54	8.31	11.08					
2.0×I <sub>r</sub>	2.50	5.00	7.50	10.00					
3.0×I <sub>r</sub>	1.11	2.22	3.33	4.44					
4.0×I <sub>r</sub>	0.63	1.25	1.88	2.50					
5.0×I <sub>r</sub>	0.40	0.80	1.20	1.60					
6.0×I <sub>r</sub>	0.28	0.56	0.83	1.11					
7.2×I <sub>r</sub>	0.19	0.39	0.58	0.77					
8.0×I <sub>r</sub>	0.16	0.31	0.47	0.63					
9.0×I <sub>r</sub>	0.12	0.25	0.37	0.49					
≥10.0×I <sub>r</sub>	0.10	0.20	0.30	0.40					

Note: When delay setting value is set to "I<sup>2</sup>T ON", the controller will carry out protection according to the inverse time method, and the definite time function will automatically become invalid. When delay setting value is set to "I<sup>2</sup>T OFF", the controller will carry out protection according to the definite time setting, and the inverse time function will automatically become invalid.

### 3.2.3 Short-circuit Instantaneous Protection Characteristics

The operation time of short-circuit instantaneous protection (including the original breaking time of the circuit breaker) should be less than 60ms.

### 3.2.4 Unsymmetrical Ground Fault / Earth Leakage Protection Characteristics

Intelligent controller's ground fault protection methods comprise inverse time protection and definite time protection.

1. Inverse time protection: When the fault current exceeds the present setting current but is smaller than  $1I_n$ , the controller will carry out protection based on the inverse time curve. When fault current exceeds  $1I_n$ , the controller will carry out protection based on the current delay setting value (which is the definite time).
2. Definite time protection: When the fault current exceeds the present setting ground fault current, the controller will carry out delay protection according to the present delay setting value.

**Table 3. Ground fault / Earth leakage protection characteristics**

I	T <sub>g</sub>									
	I <sup>2</sup> T ON				I <sup>2</sup> T OFF					
	0.1	0.2	0.3	0.4	0	0.1	0.2	0.3	0.4	
0.2×I <sub>n</sub>	2.50	5.00	7.50	10.00	0.06	0.10	0.20	0.30	0.40	
0.3×I <sub>n</sub>	1.11	2.22	3.33	4.44						
0.4×I <sub>n</sub>	0.63	1.25	1.88	2.50						
0.5×I <sub>n</sub>	0.40	0.80	1.20	1.60						
0.6×I <sub>n</sub>	0.28	0.56	0.83	1.11						
0.7×I <sub>n</sub>	0.20	0.41	0.61	0.82						
0.8×I <sub>n</sub>	0.16	0.31	0.47	0.63						
0.9×I <sub>n</sub>	0.12	0.25	0.37	0.49						
≥1.0×I <sub>n</sub>	0.10	0.20	0.30	0.40						

There are two kinds of protection modes for the controller. One is the vector sum mode of internal transformer (ground fault protection). The controller carries out protection according to the three-phase current and neutral polar current vector. The number of poles of circuit breakers can be divided into three types, 3PT, 4PT, and 3P+N. This method in general is suitable for a balanced load. It is not suitable for an imbalanced load or a motor load.

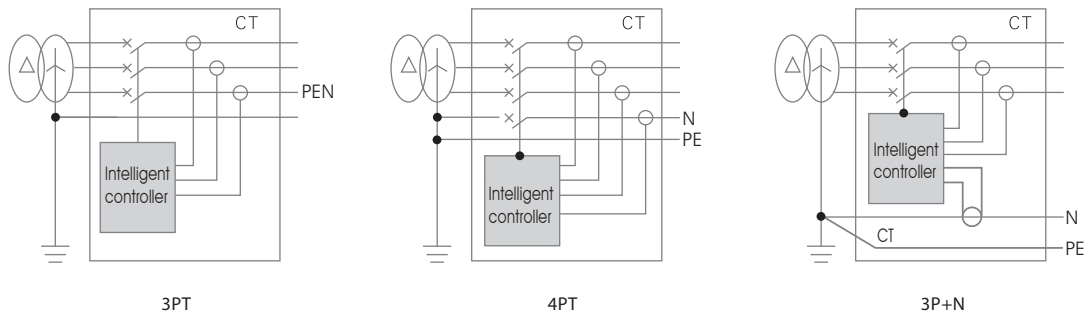

Another is transformer mode of external Earth Leakage. The controller gets the output current signal from a current transformer directly to protect. Generally, the secondary output of the transformer is 30A/300mA. This mode has higher sensibility especially applied to protect earth fault whose current is smaller beginning from tens of amperes. There are two methods of ground signal's sampling. One is rectangular transformer sampling mode (shown as follow Mode1, Model 2).

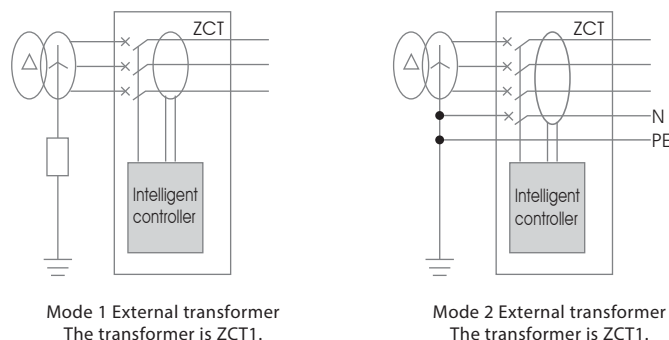

Mode 1 External transformer  
The transformer is ZCT1.

Mode 2 External transformer  
The transformer is ZCT1.

### 3.2.5 Load Monitoring Protection Characteristics (Only for XSIC-P controller)

Technical parameters of load monitoring protection characteristics of the controllers are listed in Table 4.

Table 4. Technical Parameters of Load Monitoring Protection Characteristics

Method 1	Current setting value	$I_{c1} = (0.5 \sim 1.0) I_r$	Adjust step length: 0.1
	Operation characteristics	Delay relay closing at $1.05 \sim 1.2 I_{c1}$	
	Delay setting value	0.5Tr protection and the characteristics are the same as overload long time delay protection.	
	Current setting value	$I_{c2} = (0.5 \sim 1.0) I_r$	Adjust step length: 0.1
	Operation characteristics	Delay relay closing at $1.05 \sim 1.2 I_{c2}$	
	Delay setting value	0.25Tr protection, and the characteristics are the same as those of overloading and long-delay.	
Method 2	Current setting value	$I_{c1} = (0.5 \sim 1.0) I_r$	Adjust step length: 0.1
	Operation characteristics	Delay relay closing at $1.05 \sim 1.2 I_{c1}$	
	Time delay setting value	0.5Tr protection and the characteristics are the same as overload long time delay .	
	Setting current	$I_{c2} = (0.5 \sim 1.0) I_r$	Adjust step length: 0.1
	Operation characteristics	$< I_{c2}$ , delay relay closing	
	Constant time lag	60s	

The controller can program the output of two passive signal contacts for load monitoring. The output signal contacts can be used for monitoring alerts, controlling the load of tripping sub-circuit and ensuring a normal power supply for the main system. There are two types of load monitoring methods available (the user can choose one of them).

1. Method 1: It can be used to control two sub-circuit loads. When the working current exceeds  $1.2I_{c1}$  or  $1.2I_{c2}$ , controller will delay the output of signal contacts according to inverse time characteristics. The characteristic curve of inverse time and the characteristic curve of overload long-delay are the same, but the setting current value can be set independently.
2. Method 2: It is generally used to control sub-circuit loads. When the working current exceeds  $1.2I_{c1}$ , the controller will output signal contact point break sub-circuit load according to inverse time characteristics. The characteristic curve of inverse time and the characteristic curve of overload long-delay are the same, but the setting value has to be  $I_{c1} \geq I_{c2}$ . If after tripping the sub-circuit load, the current will return to normal. When the current is lower than  $I_{c2}$  for 60s continuously, the controller will output another signal contact to pick up the broken load and restore the power supply of system.

### 3.2.6 Open-phase Protection Characteristics

Open-phase protection provides protection for Open-phase according to the present three-phase current imbalance rate. The current unbalance rate equation is shown below.

$$\delta = |I - I_{av}| / I_{av}$$

In the equation:  $I_{av}$  is the average of three-phase current.

The feature of Open-phase protection is definite time protection. The delay setting value is  $t_{\delta}$ . If the setting is "OFF", the Open-phase protection function is off.

Technical parameters of Open-phase protection characteristics of the controllers are listed in Table 5.

Table 5. Technical Parameters of Open-phase Protection Characteristics

Open-phase protection setting value	$\delta =$	90%~99% + OFF(OFF means that the function has been turned off)
	Operation characteristics	Tripped at 0.9-1.1 $\delta$
	Time delay setting value $t_{\delta}$ (s)	1 ~ 40 s
	Tripping time	Definite time

### 3.2.7 Other Functions

#### Test functions

The controller uses the instantaneous mode to simulate tripping for testing. After the test, tripping action will be generated. This test is used for coordinating the controller with the circuit breaker for onsite-tripping tests, routine check, or repairing and checking the coordination between the controller and the circuit breaker. Press the red restore button on the panel of the controller before closing the circuit breaker for starting the operation. Do not use it during normal operation.

#### Fault record functions

If there is any controller fault (either tripping or self-diagnosed faults), all relevant conditions and data of the fault will be recorded. After restarting after a fault or power failure, fault memory function is still available and can keep ten latest fault cases for later analysis. Concrete query methods are presented in 8.2.3.

The tripping type of faults include overload, short-circuit, instantaneous, ground fault / earth leakage (optional), and Open-phase.

Self-diagnosed faults include overheated, worn contact, and failure to trip.

#### Self-diagnosed functions

When the working environment of the controller exceeds 70°C or when 60% of the contact has been worn off, or when the circuit breaker cannot be tripped, the light "TAL" on the controller panel will be on to alert the user. Relevant parameters will be recorded for later inquiry.

#### Thermal memory functions

Repeated overload can heat up the conductor or other devices. The controller can simulate the heating conditions as well as the overload long-delay, short-circuit delay, and other fault or delay actions to generate the thermal effect (simulating characteristics of the double-metal piece). The overload long-delay thermal effect energy will be completely released in 30 minutes after eliminating the fault. For short-circuit delay thermal effect energy, it will be completely released in 15 minutes after eliminating the fault. During the period, the delay time will be shortened if the reclosing circuit breaker has overload long-delay or short circuit short-delay. This is to provide circuits and devices better protection.

If the controller is turned off first and then turned on, all the accumulated thermal effect will be cleared.

The factory default of this function is "ON", which means that the thermal memory function is running.

**System clock function**

The system has a clock function for recording the time and date when faults happen. For adjusting the system clock, the method is presented in 8.2.3.

**Alert signal function (Only for XSIC-P controllers)**

The controller has four sets of independent signal contact output. This function can be set using the control panel or remote communication. For contact function, please refer to Table 6. For the factory default of the four contact sets of the controller, please refer to Table 7.

Table 6. Contact Functions

Code	Function
0	No definition
1	Instantaneous fault tripping alert
2	Short-circuit fault tripping alert
3	Overload fault tripping alert
4	Ground Fault/Earth leakage fault tripping alert
5	Self-diagnosed fault alert
6	Machine open alert
7	Open-phase fault tripping alert
8	Load1 shedding
9	Load 2 shedding/Load 1 reloading
10	Remote control, opening
11	Remote control, closing

Table 7. Factory Default Setup for the Four Contact Sets of the Controller

Controller types \ Contact code	Contact 1	Contact 2	Contact 3	Contact 4
XSIC-P	Remote Opening	Remote Closing	Overload	Self-diagnosis

**Simulating calculation of circuit breaker contact wearing rate**

The controller will simulate and calculate the circuit breaker's main contact wearing rate according to information such as the fault current at tripping. The contact value of the controller from the factory is 100%, indicating no wearing of the contact point. The contact will be worn by a certain level due to every fault induced tripping. If the value obtained from subtracting the corresponding amount of wearing from the current contact value is less than 40%, the system will send out a self-diagnosed fault alert signal (by the "TAL" light and the contact signal, if such functions have been set) to notify the user to carry out maintenance.

After changing the main contact of the circuit breaker, the user can reset the initial wear rate to 100% through the main-machine interface or remote communication.



## 4. Characteristic Curves

### 4.1 Overload Long Time Delay

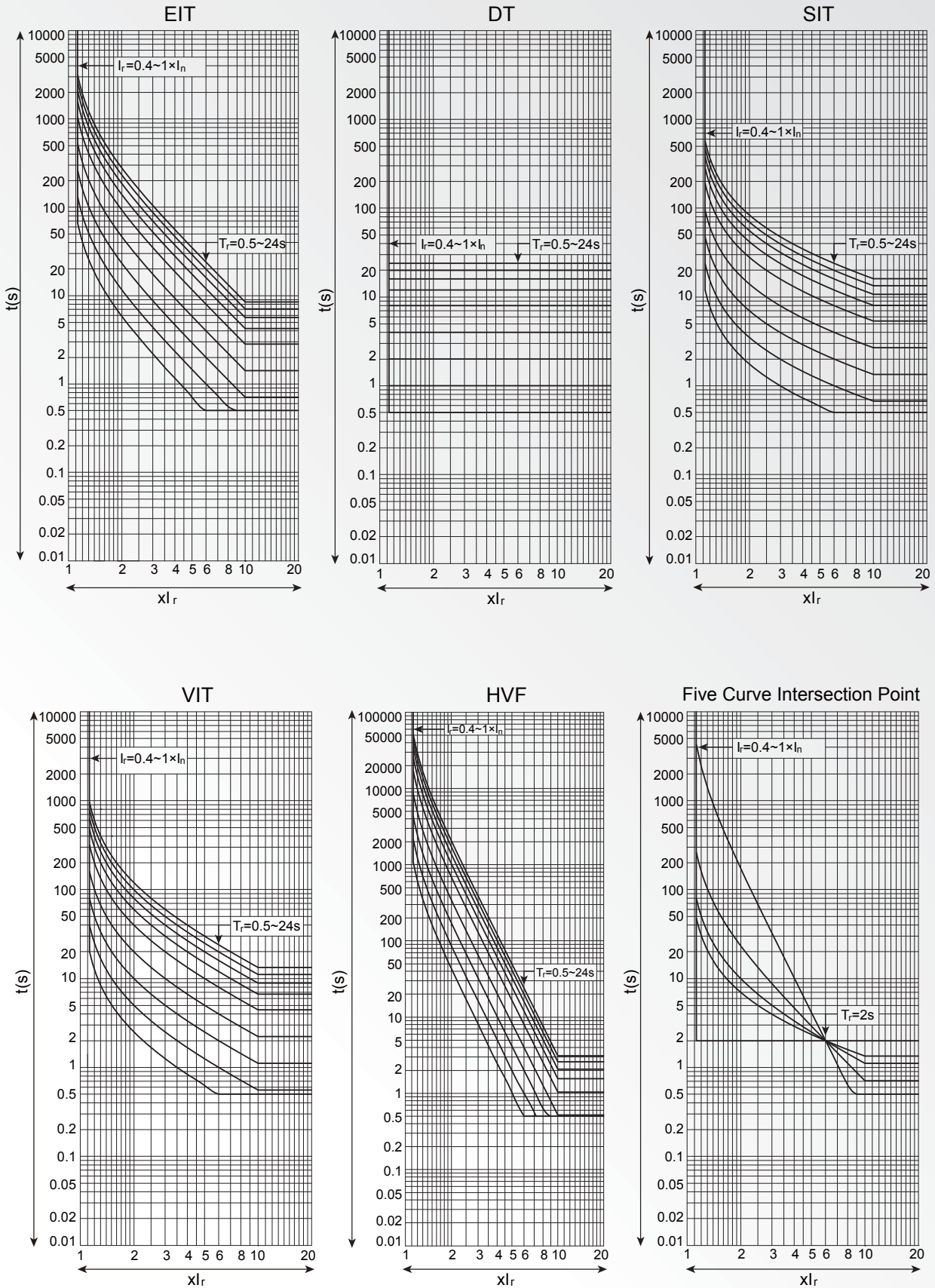

### 4.2 Short Circuit Short Time Delay

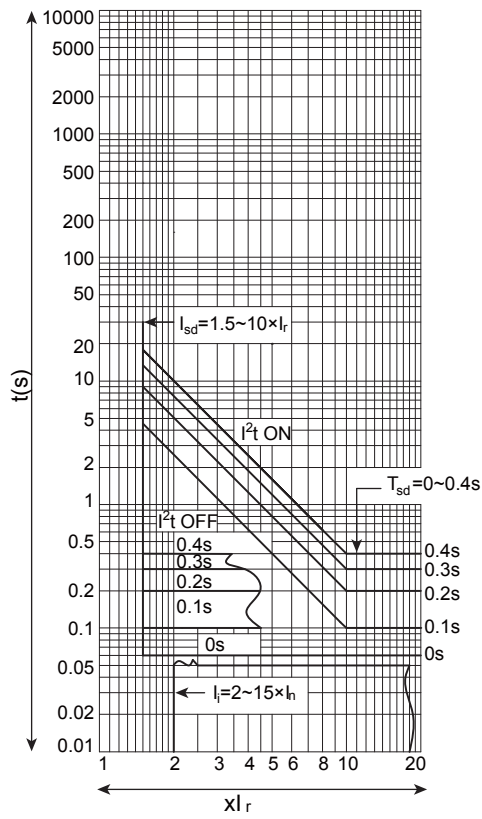

### 4.3 Short Circuit Instantaneous

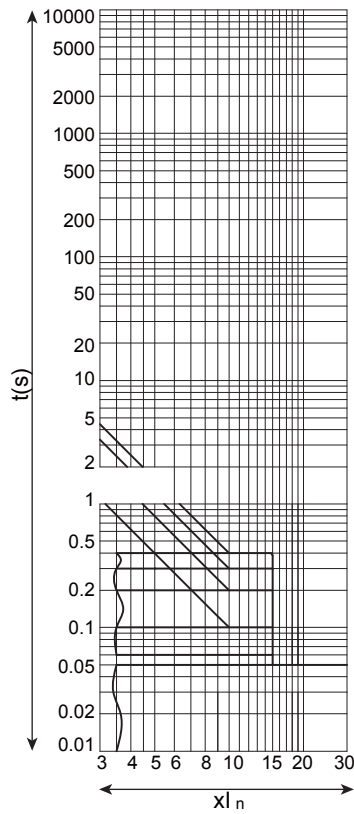

### 4.4 Ground Fault

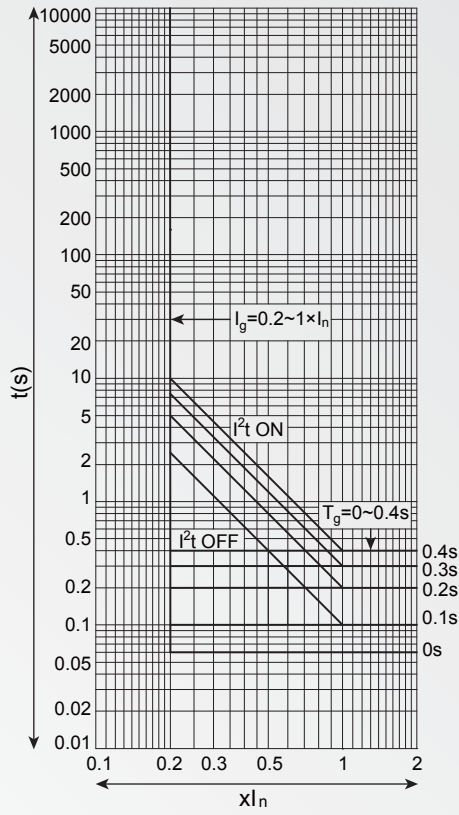

### 4.5 Earth Leakage

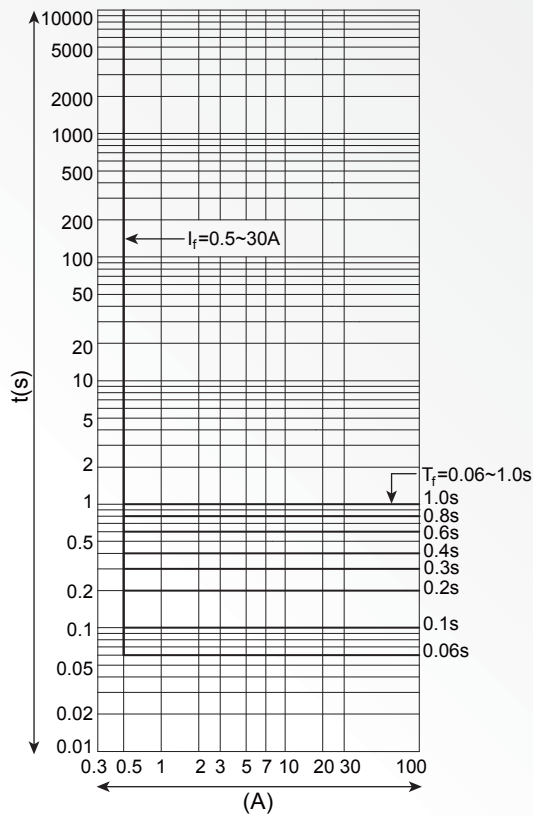

## 5. Accessories and functions

### 5.1 Shunt release, Undervoltage release, Motor-driven, Closing coil

Rated voltage	AC				DC	
Required power Items	220V	240V	380V	415V	110V	220V
Shunt release	24VA	25VA	36VA	38VA	—	24W
Under voltage release	24VA	24VA	36VA	24VA	—	—
Motor-driven mechanism	85VA/ 110VA/ 150W	85VA / 110VA / 150W	85VA/ 110VA/ 150W	85VA / 110VA / 150W	85W/ 110W/ 150W	85VA/ 110W
Closing coil	24VA	25VA	36VA	38VA	—	24W

Note: 1. Operating voltage range:

- Shunt release: 70%~110%
- Closing coil: 85%~110%

2. SHT:

Instantaneous type: Activate only once, no matter how long it's the control power is given

- SHT: Can be installed with UVT

Continues type: Stay activated as long as the control voltage is given

- SHT1: The control module is installed internally. Due to fitting space of ACB, Cannot installed with UVT
- SHT2: The control module is installed externally, can be installed with UVT together



### Characteristic of circuit-breaker under-voltage release

Types		Time delay	Instantaneous
Setting range		0.3/0.5/0.7/1/3/5s	Instant
Operating voltage range	35 ~ 70% Ue	Break the circuit breaker	
	≤35% Ue	the circuit breaker cannot closed	
	≥85% ~ 110% Ue	Reliable close the circuit breaker	
Operating voltage up to 85% Ue in 1/2 delay time		No break of circuit breaker	

Note: Accuracy: ±10% .

### 5.2 Auxiliary contacts

Thermal rated current of auxiliary contact: 6A

Auxiliary contact: 4NO 4NC (standard), 6NO 6NC (Option)



a. Auxiliary contacts performance in abnormal operation

Type	Model	Power (Pe)	VAC (Ue)	Connection performance				Operation time and frequency W/ input		
				U/ Ue	I/ Ie	COSθ	T0.95 (ms)	Time in 1 cycle	Time in 1 sec	Time for input (s)
AC	AC-15	300VA	380V	1.1	10	0.3	—	10	6 (or same as input operation time)	0.05
DC	DC-13	60W	220V	1.1	1.1	—	300			
AC	DC-13	100W	240V	1.1	1.1	—	300	10	6	0.05
AC	AC-15	350VA	415V	1.1	10	0.3	—	10	6	0.05

b. Auxiliary contacts performance in normal operation

Type	Model	Power (Pe)	VAC (Ue)	Connection performance				Break performance			
				U/ Ue	I/ Ie	COSθ	T0.95 (ms)	U/ Ue	I/ Ie	COSθ	T0.95 (ms)
AC	AC-15	300VA	380V	1	10	0.3	—	1	10	0.3	—
DC	DC-13	60W	220V	1	1	—	300	1	1	—	300
AC	DC-13	100W	240V	1	1	—	300	1	1	—	300
AC	AC-15	350VA	415V	1	10	0.3	—	1	10	0.3	—

Note: Life time of Auxiliary contacts is 6,000 times. 6 times of operation cycle is same as main circuit, and the minimum connection time is 0.05 sec which is same as input connection.

### 5.3 Lock devices (optional)

#### 5.3.1 Mechanical interlock (ATS use)

The interlock device is installed on the right side of ACB. The maximum of 3 units of ACB can be installed vertically, and 2 units horizontally. It prevents the 2 or 3 ACBs close at the same time.

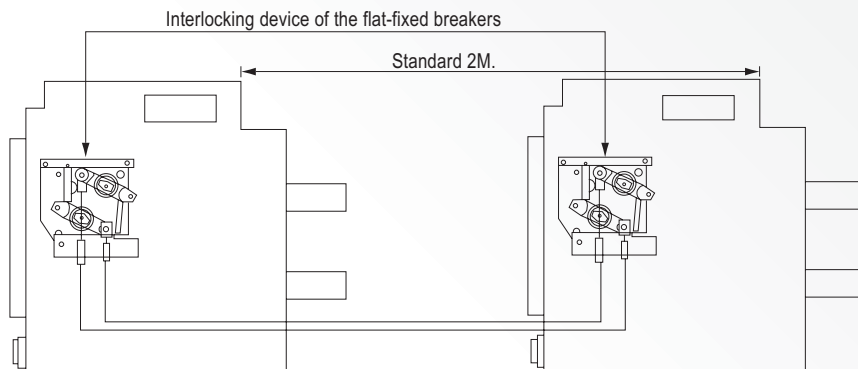
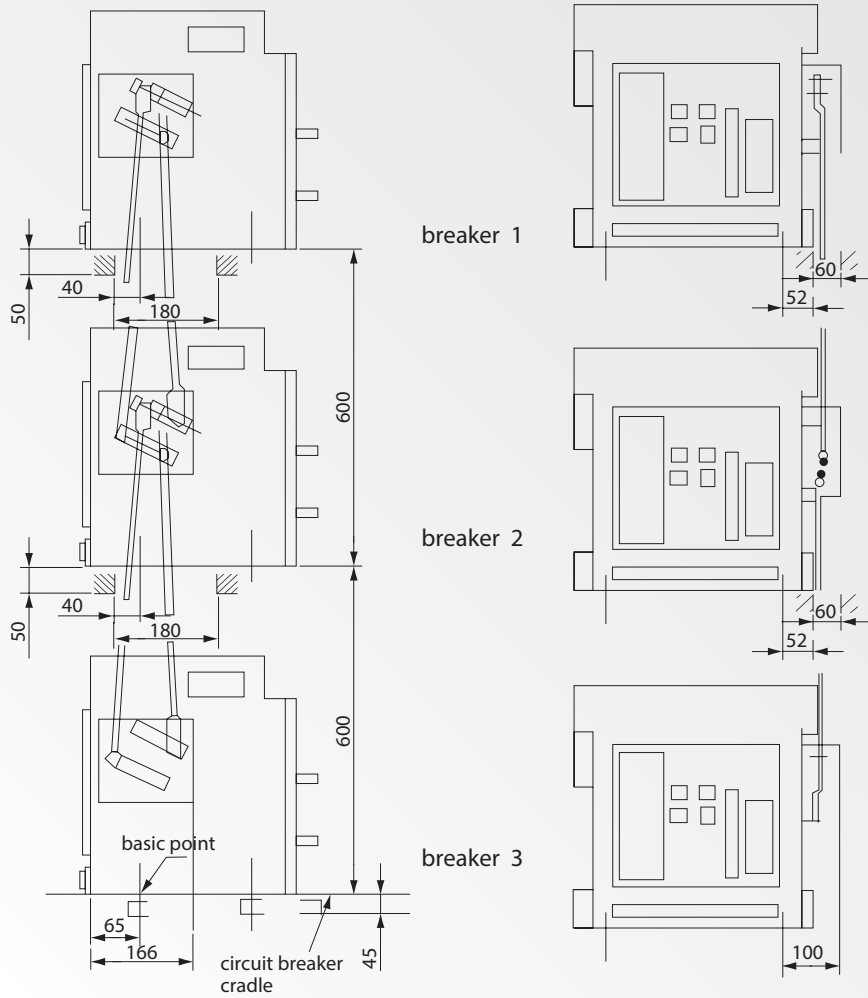

## ACB mechanical interlock action figure

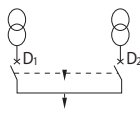
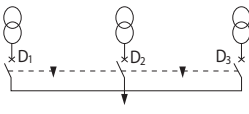
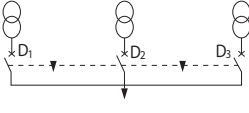
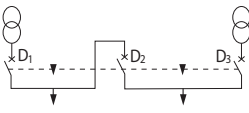
wiring	possible cause		wiring	possible cause		
	D <sub>1</sub>	D <sub>2</sub>		D <sub>1</sub>	D <sub>2</sub>	D <sub>3</sub>
	0	0		0	0	0
	0	1		1	0	0
	1	0		0	1	1
				0	1	0
	possible cause		possible cause			
	D <sub>1</sub>	D <sub>2</sub>	D <sub>3</sub>	D <sub>1</sub>	D <sub>2</sub>	D <sub>3</sub>
	0	0	0	0	0	0
	1	0	0	1	0	0
				0	1	0
				0	0	1
	possible cause		possible cause			
	D <sub>1</sub>	D <sub>2</sub>	D <sub>3</sub>	D <sub>1</sub>	D <sub>2</sub>	D <sub>3</sub>
	0	0	0	0	0	0
	1	0	0	1	0	0
				0	1	0
				0	0	1
				1	1	0
				0	1	1
				1	0	1

### 5.3.2 Three-lock-two-key interlocking device (Fig. 1)

The three-lock-two-key interlocking devices are used on occasions where the breakers are fixed dispersedly. The locks are fixed on the panels of the three breakers separately. When the key had been inserted and rotated to horizontal position, the breaker can carry on make-break operation. The closed breaker will be broken if rotate the key anticlockwise from horizontal to vertical position. At the same time, making operation is forbidden and the key is allowed to take out. It ensures that there are not more than two breakers can be closed at the same time because there are only two keys for three locks.



(Fig. 1)

#### 5.3.2.1 Key lock (Fig. 1)

The structure of the breaking lock is the same as the three-lock-two-key. However, there is only one key for one lock. If the off button of the breaker is locked, the on button will be disabled.



(Fig. 2)

#### 5.3.4 Button lock (Fig. 2)

The cover on the ON/OFF button with padlock position attached on ACB panel. This device doesn't come with padlock.



(Fig. 3)

#### 5.3.5 Racking lock (Fig. 3) (Standard)

It is used in drawout type breaker and it is possible to lock the disconnection, connection, test positions.

#### 5.3.6 Position lock (Fig. 4)

The red color button will pop up and lock the breaker main body in the position of disconnected, test or connected.

Press the red button for continuing draw in/out the main body.

The padlock can be attached on this device.



(Fig. 4)

#### 5.3.3 Door interlock (Fig. 5)

This prevents the compartment door to be opened when the circuit breaker closed. The door interlock fixed in the foot right corner of the drawer seat.

- The door interlock is allowed to close or open at will if the breaker is at the disconnection position (relative to cradle).
- Breaker can be pushed in or pulled out to any position between connection and disconnection if the compartment door opens.
- Breaker will be locked once the door is closed after the breaker leaving the disconnection position.



(Fig. 5)

## 5.4 Testing Kit

This testing device (ACB Tester) is an optional accessory, specific for ACB XSIC-II Intelligent controller. ACB tester is mainly used to test ACB at site for routine check or repairing.



## 6. Wiring

### 6.1 Controller and Circuit Breaker Wiring

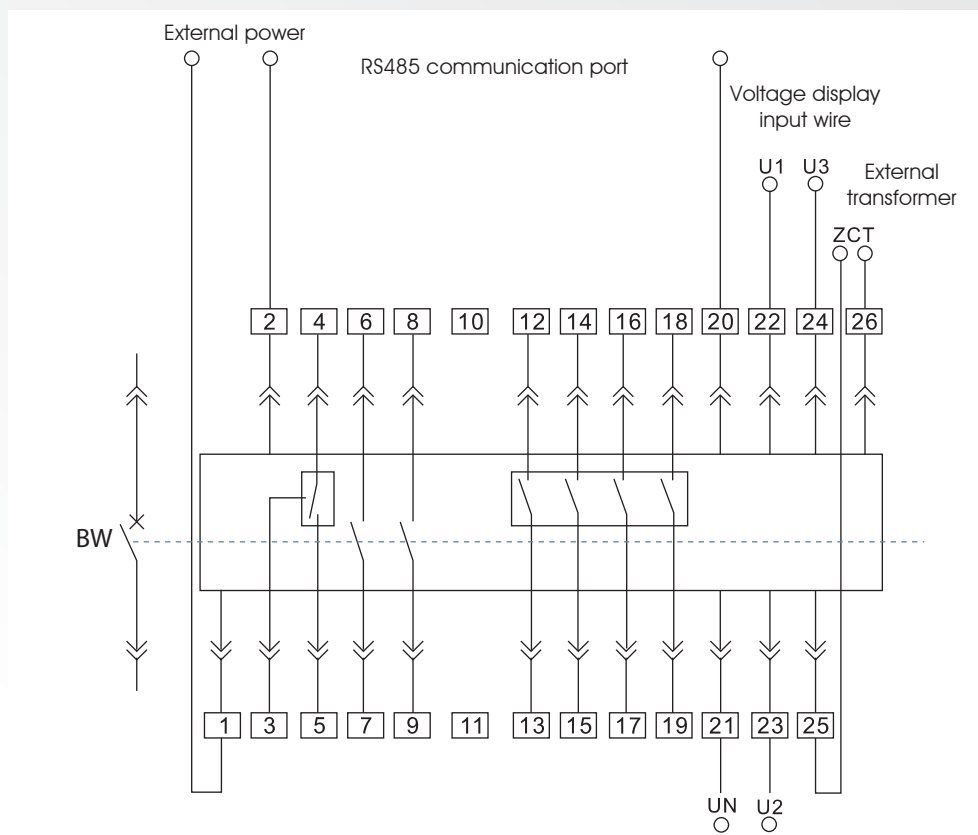

#### Leading wire functions:

- # 1 and # 2 : It is the working power supply input; For DC working power, # 1 is the positive end.
- # 3 , # 4 and # 5 : It is the output of fault tripping contact ( # 4 is the shared end).
- # 6 , # 7 and # 8 , # 9 : It is the status auxiliary contact of two circuit breaker sets.
- # 10 and # 11 : It is terminal A and B of RS485 communication outlet leading-out-wire (Only for XISC-P).
- # 12 and # 13 : It is the output terminal of signal contact of the first group of the controller (Only for XISC-P).
- # 14 and # 15 : It is the output terminal of signal contact of the second group of the controller (Only for XISC-P).
- # 16 and # 17 : It is the output terminal of signal contact of the third group of the controller (Only for XISC-P).
- # 18 and # 19 : It is the output terminal of signal contact of the fourth group of the controller (Only for XISC-P).
- # 20 : It is for ground wire protection.
- # 21 , # 22 , # 23 and # 24 : It is the voltage display input terminal (Only for XSIC-P).
- # 25 and # 26 : It is the input terminal of external transformer (Earth Leakage protection or for 3P+N).

Note: Contact capacity for #3, 4, 5, 6, 7, 8, 9: AC1/AC380V/2A, DC1/DC250V/0.3A

Contact capacity for #12, 13, 14, 15, 16, 17, 18 ,19: AC1/AC250V/2A, DC1/DC30V/2A



## 6.2 Secondary Wiring Diagram

### 6.2.1 XSIC-A Series Intelligent Controller

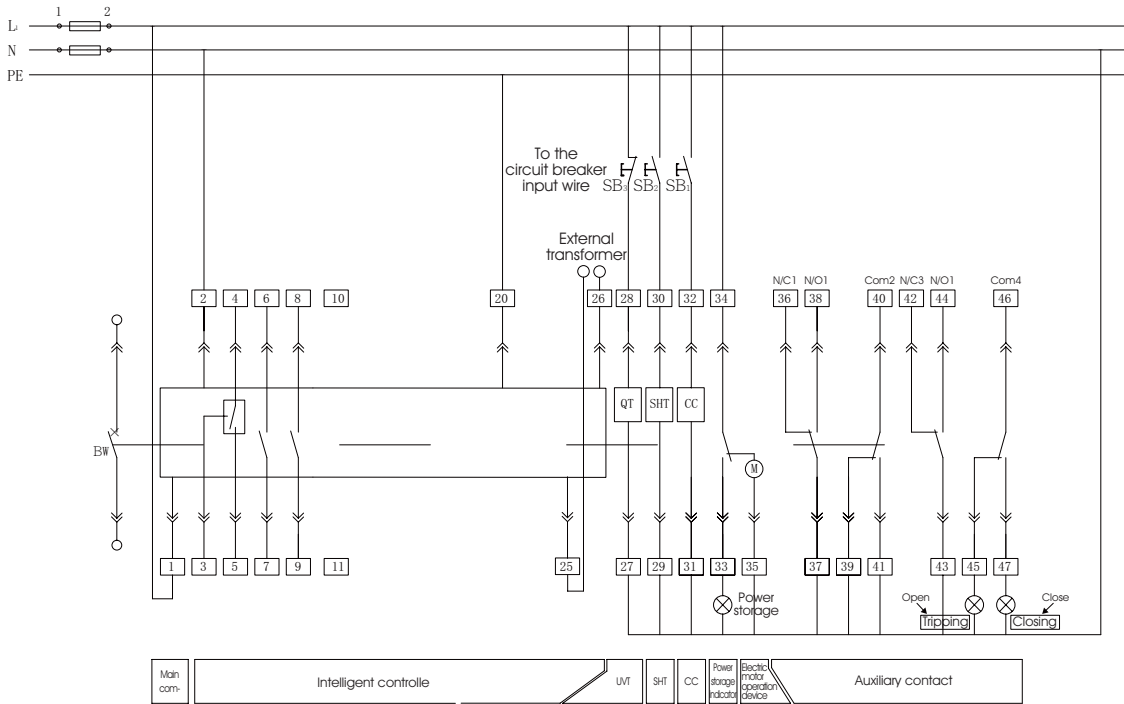

### 6.2.2 XSIC-P Series Intelligent Controller

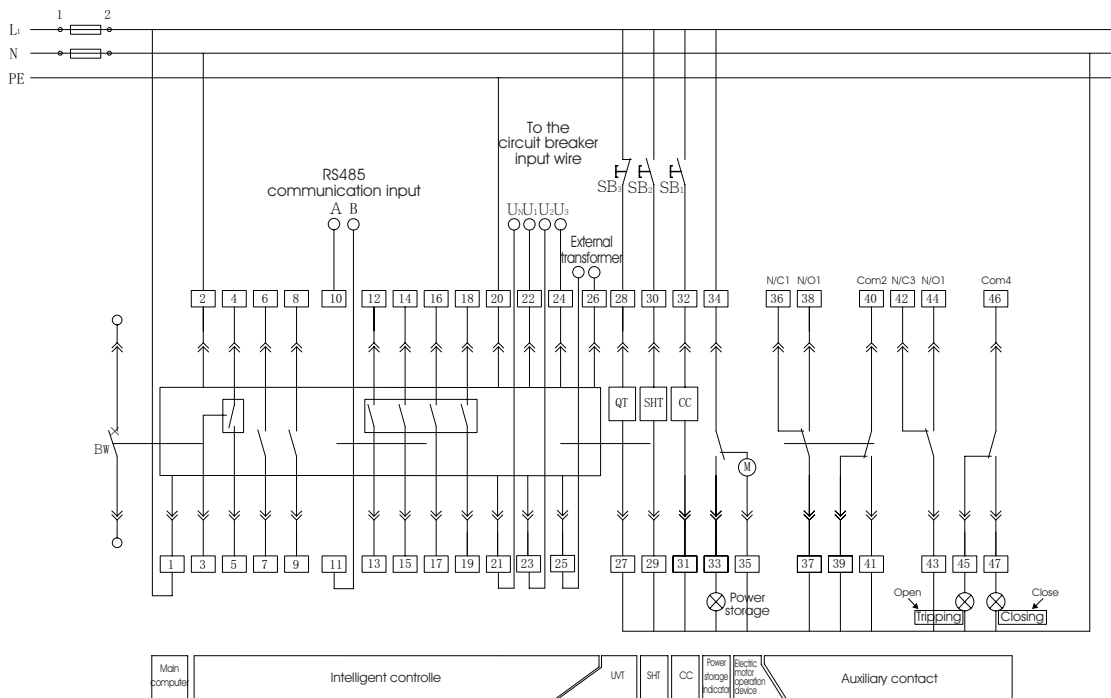

### 6.2.3 ATS Wiring Diagram

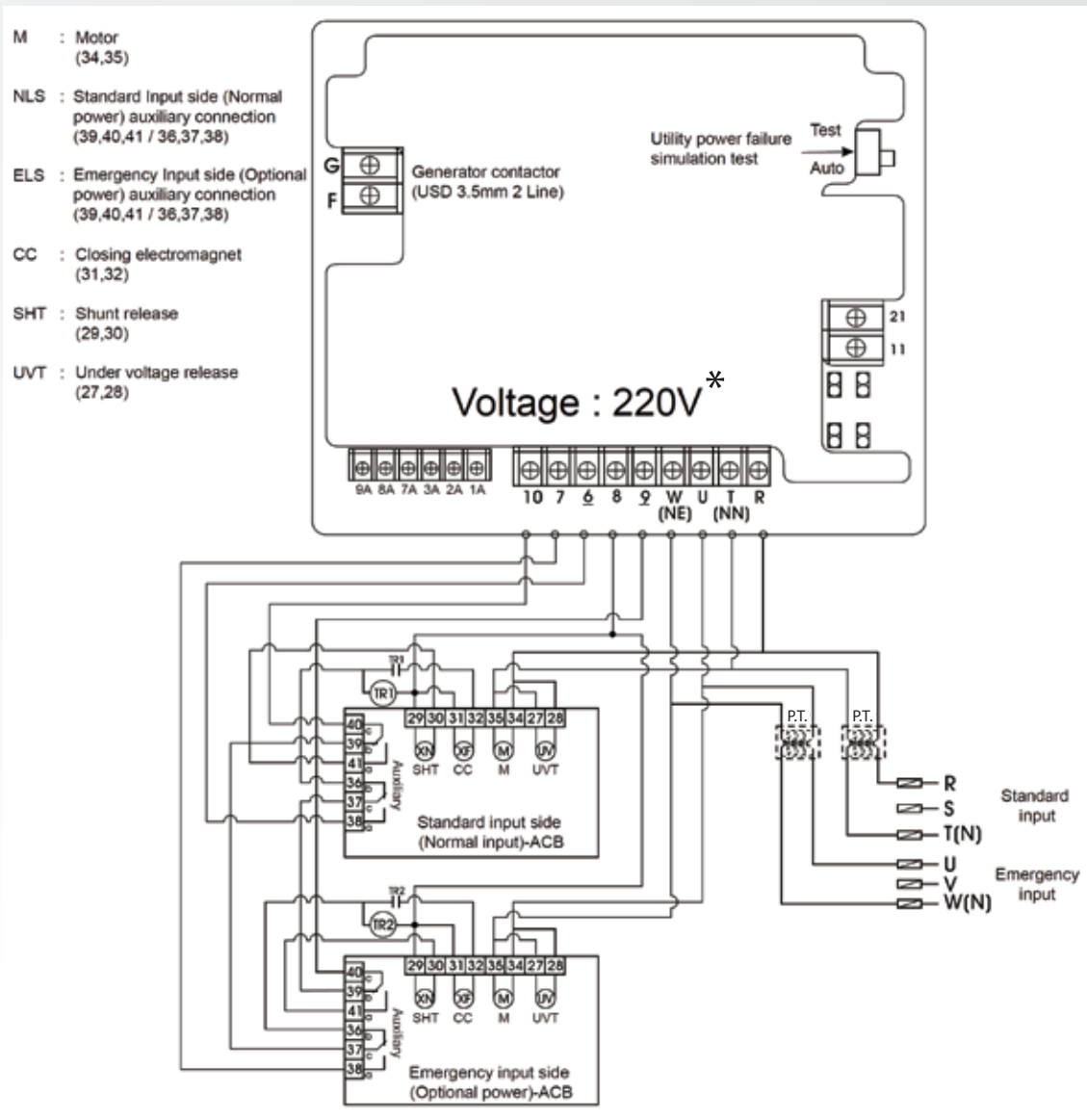

**Attention:**

1. TR1 ∨ TR2: Timer relays are additional device, delay time≥5s. (Not included)
2. Input control voltage is AC220V or AC240V, please use transformer to step up or step down the voltage(Transformer capacity is 300VA or above)
3. Control voltage of ACB/Shunt Release/Closing Coil/Motor-driven Mechanism/Under-voltage Release: AC220V or AC240V.

\* AC240V is option, please specify when order.

## 7. Outline and Installation Dimensions

### 7.1 Draw-out type outline

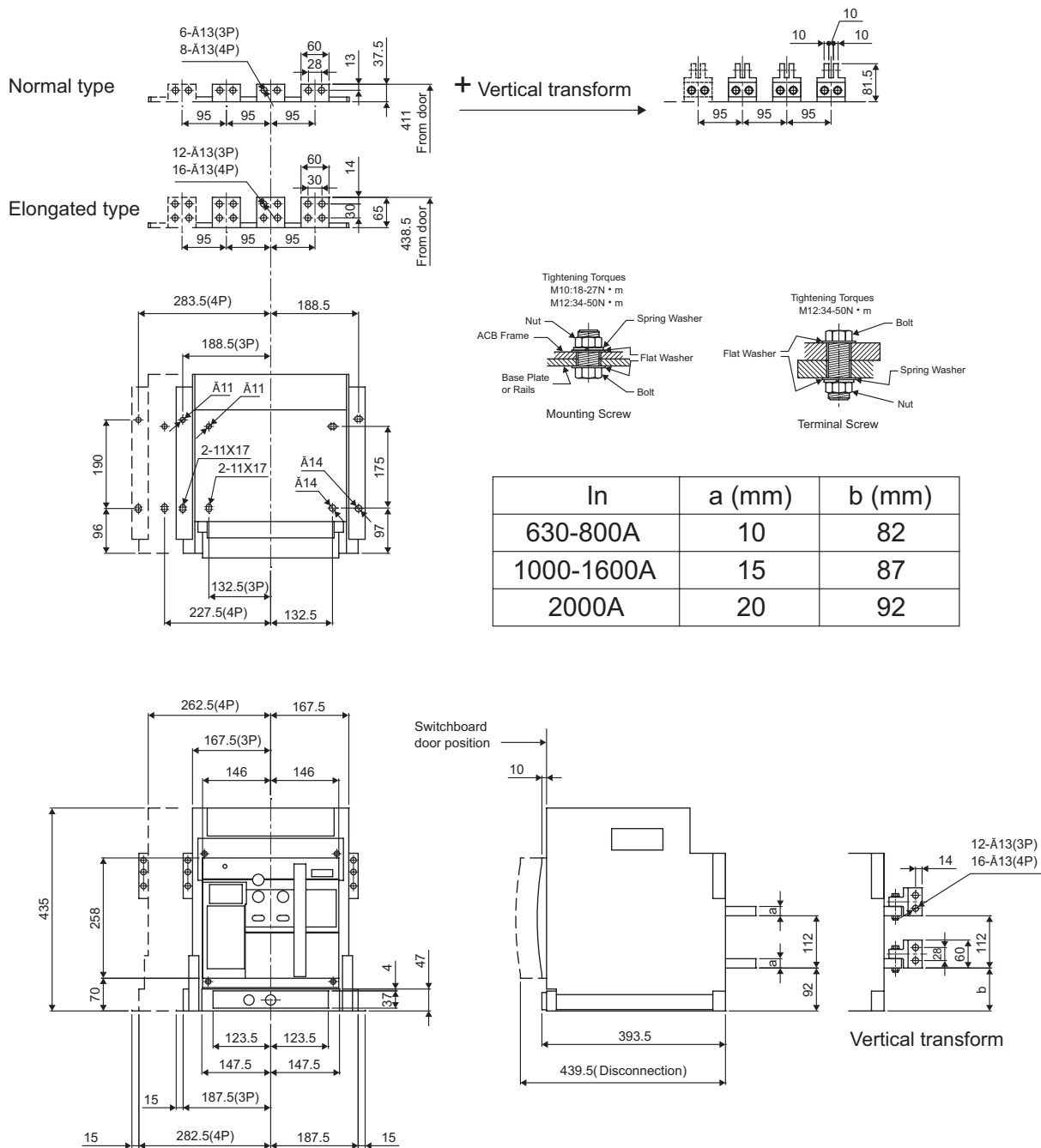

Draw-out type BW-2000 3P / 4P

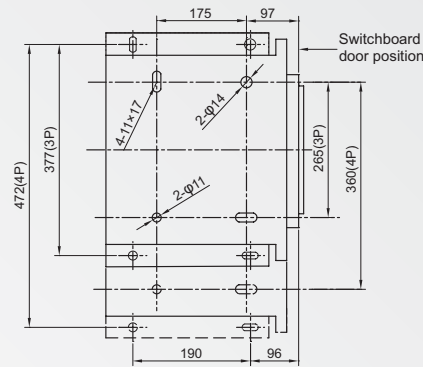
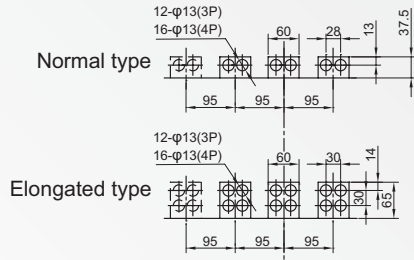
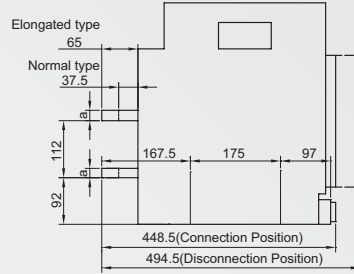
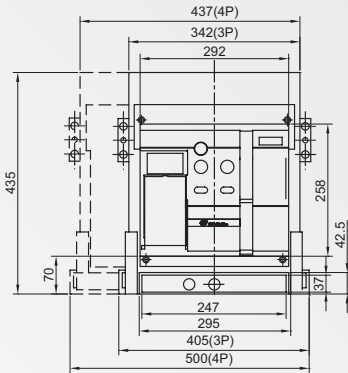

In	a mm
400-800A	10
1000-1600A	15
2000A	20

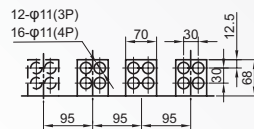
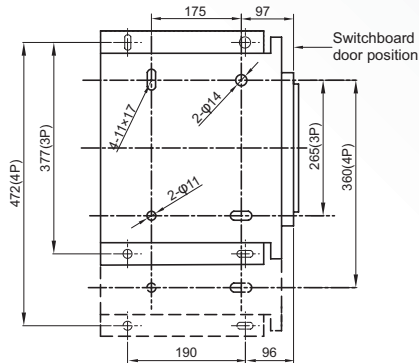
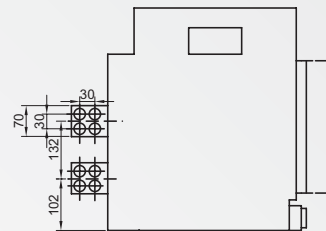
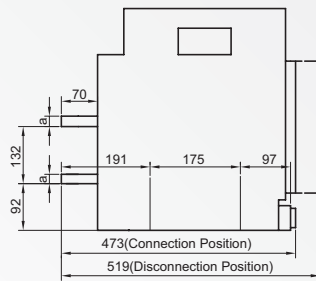
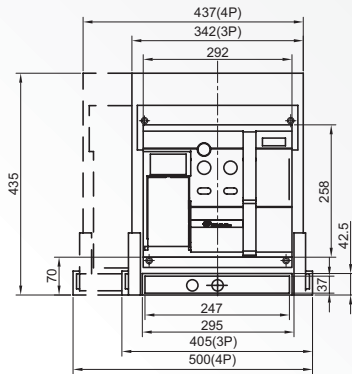

Horizontal

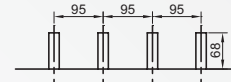

Vertical

In	a mm
2500A	20

Draw-out type BWA-2500 3P / 4P

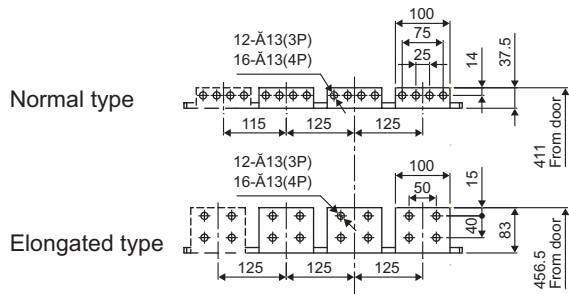

+ Vertical transform

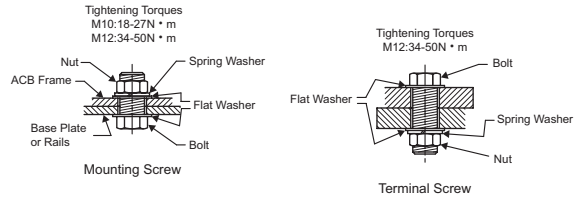
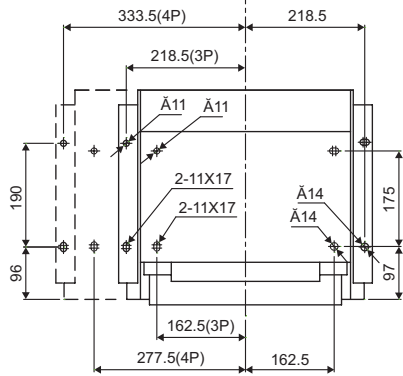
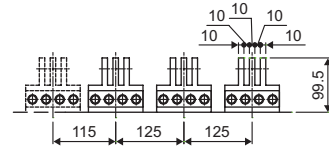

In	a (mm)	b (mm)
2000-2500A	20	162
3200A	30	172

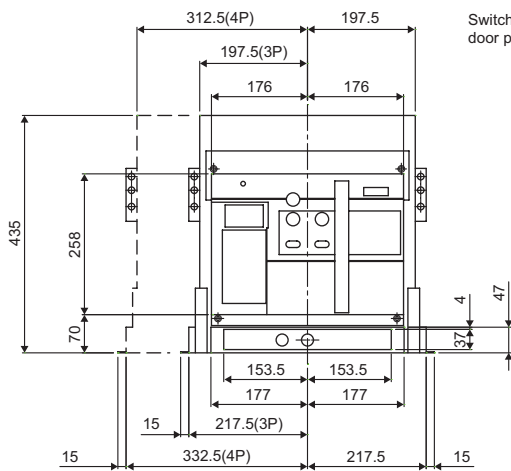

Switchboard door position

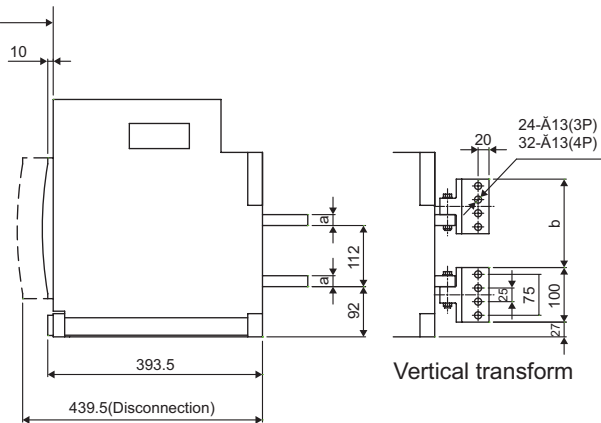

Vertical transform

Draw-out type BW-3200 3P / 4P

In	a (mm)
3200-4000A	20

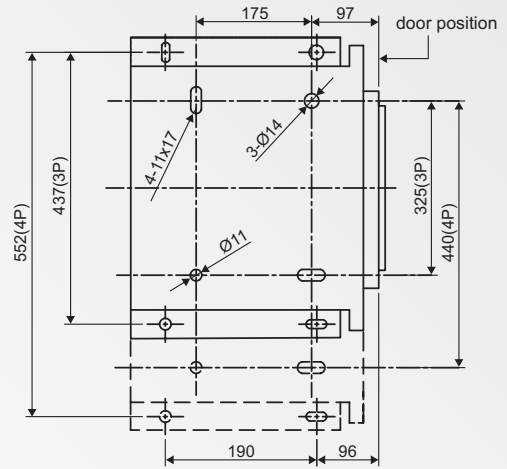
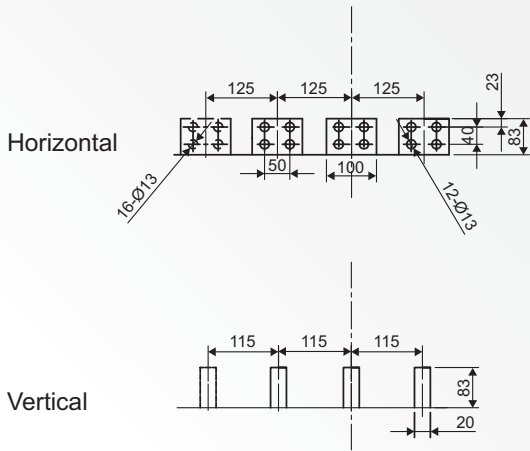
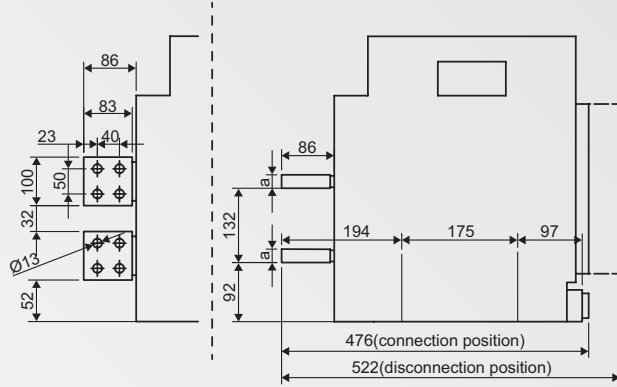
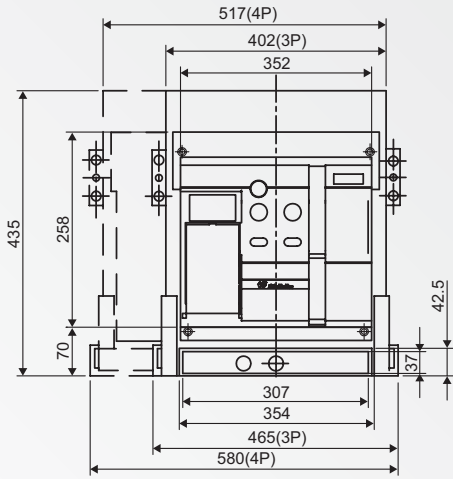
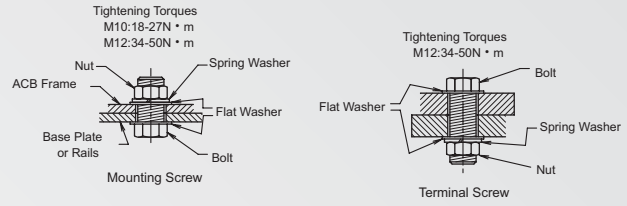

Draw-out type BW-4000 3P / 4P

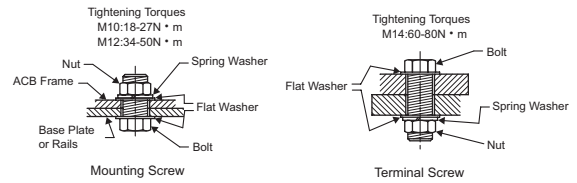
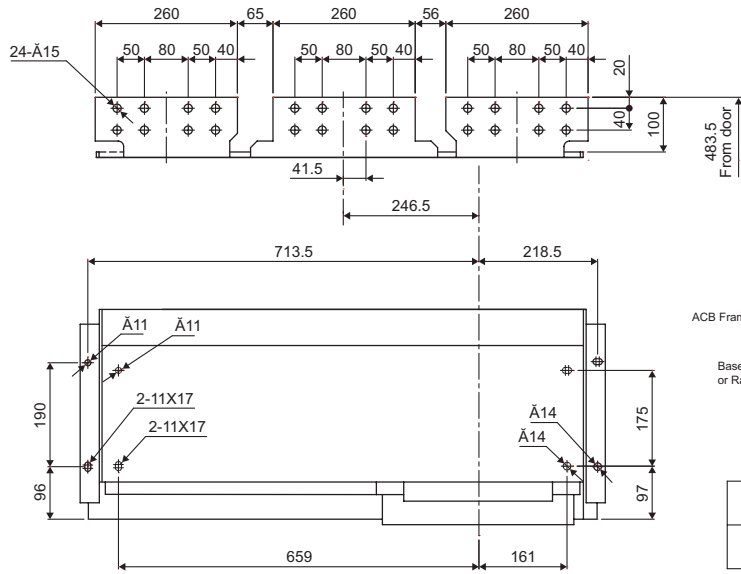

In	a (mm)
6300A	30

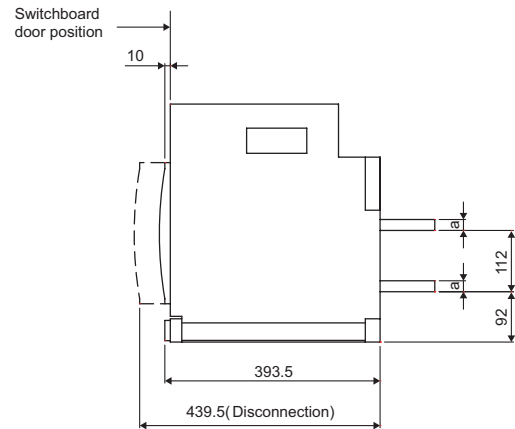
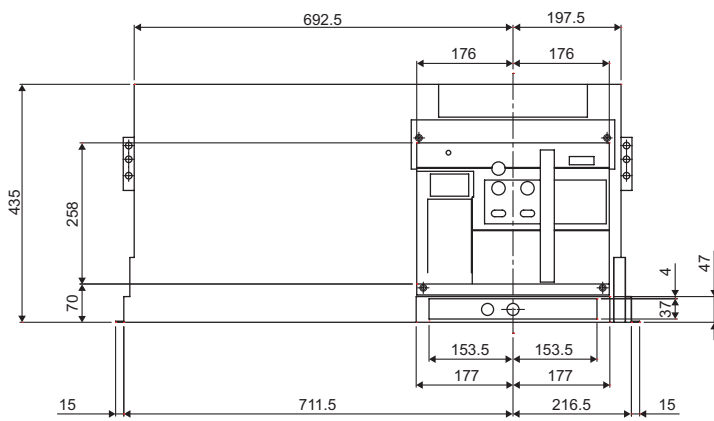

Draw-out type BW-6300 (6300A) 3P





## 7.2 Fixed type outline

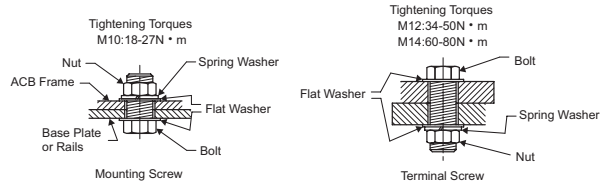
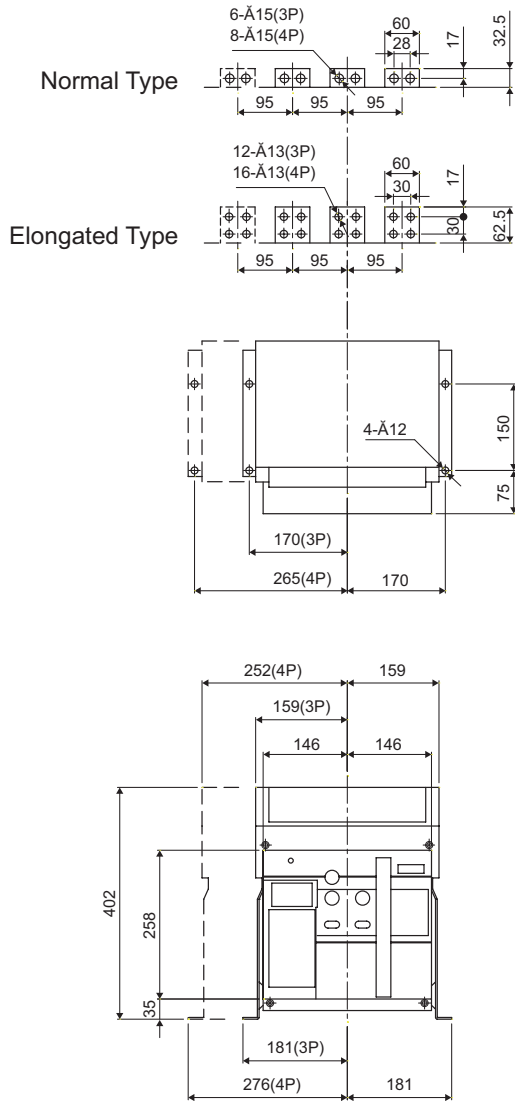

In	a (mm)
630-800A	10
1000-1600A	15
2000A	20

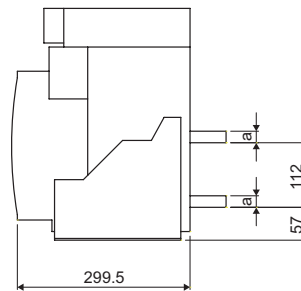

Fixed type BW-2000 3P / 4P

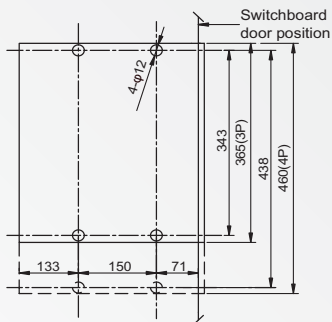
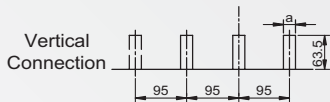
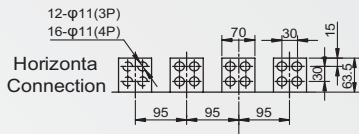

In	a mm
400-800A	10
1000-1600A	15
2000-2500A	20

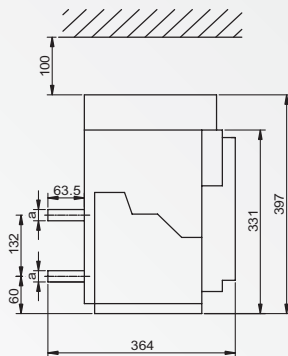
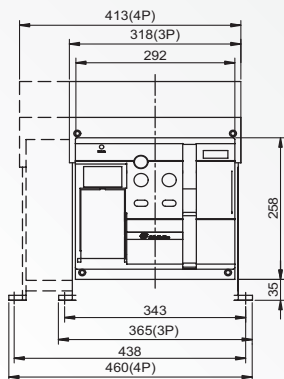

Horizontal Type

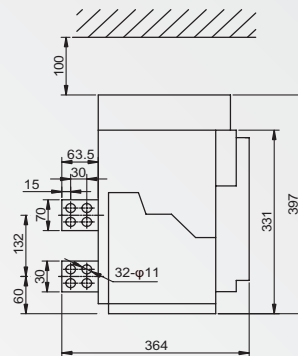

Vertical Type

Fixed type BWA-2500 3P / 4P

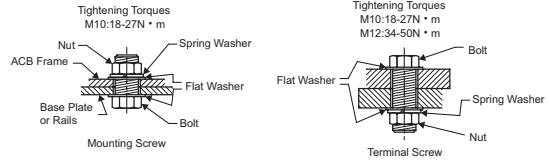
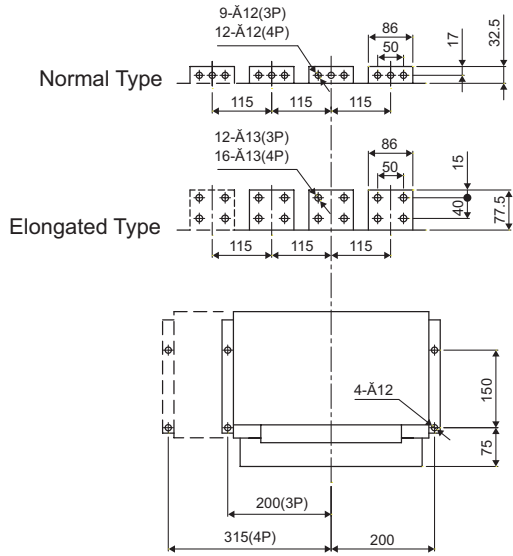

In	a (mm)
2000-2500A	20
3200A	30

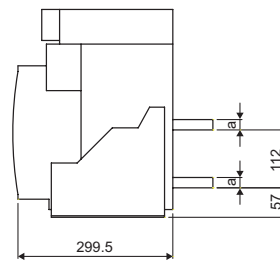
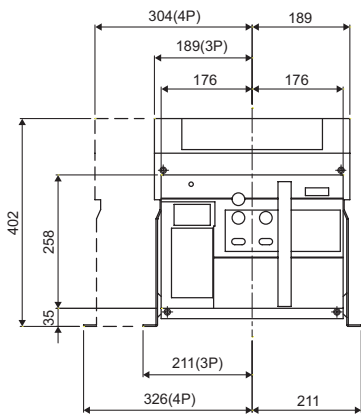

Fixed type BW-3200 3P / 4P

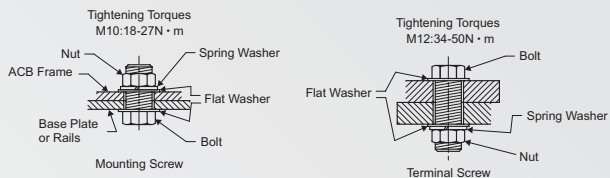
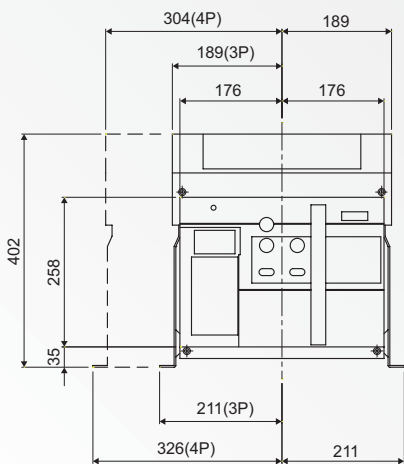
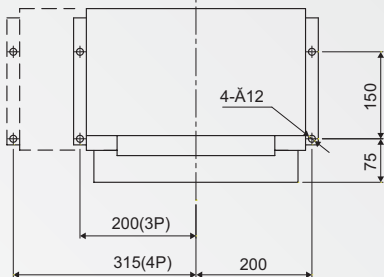
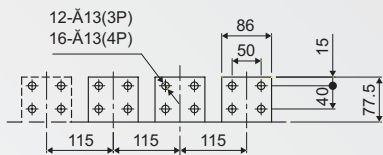

In	a (mm)
3200A	30
4000A	30

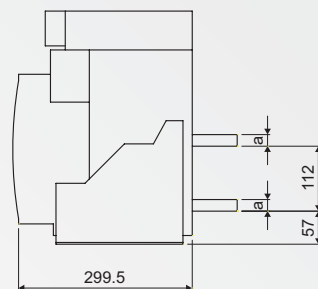

Fixed type BW-4000 3P / 4P

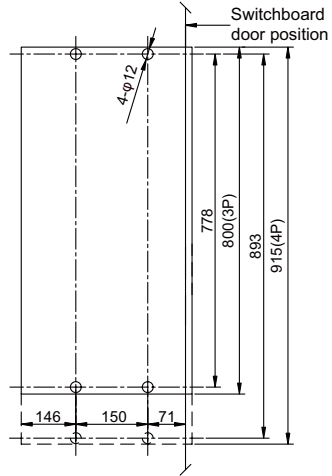
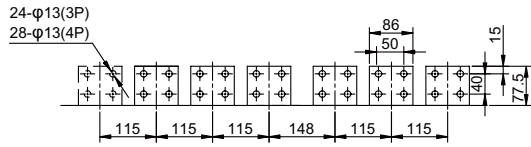

In	a mm
4000A	20
5000-6300A	30

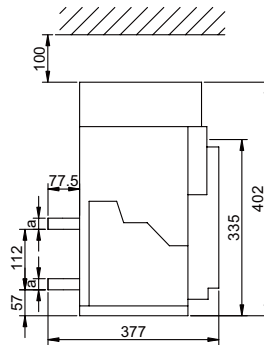
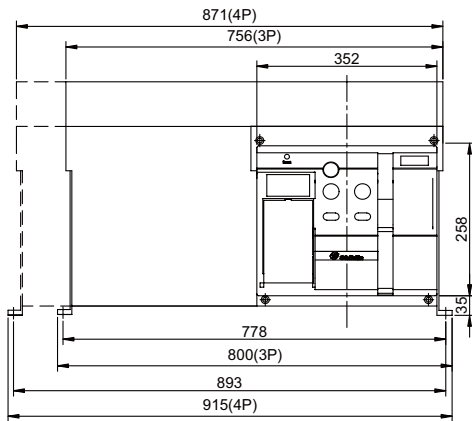

Fixed type BW-6300N 3P / 4P

### 7.3 Compartment Hole Drilling Dimensions and Mounting Hole Distance

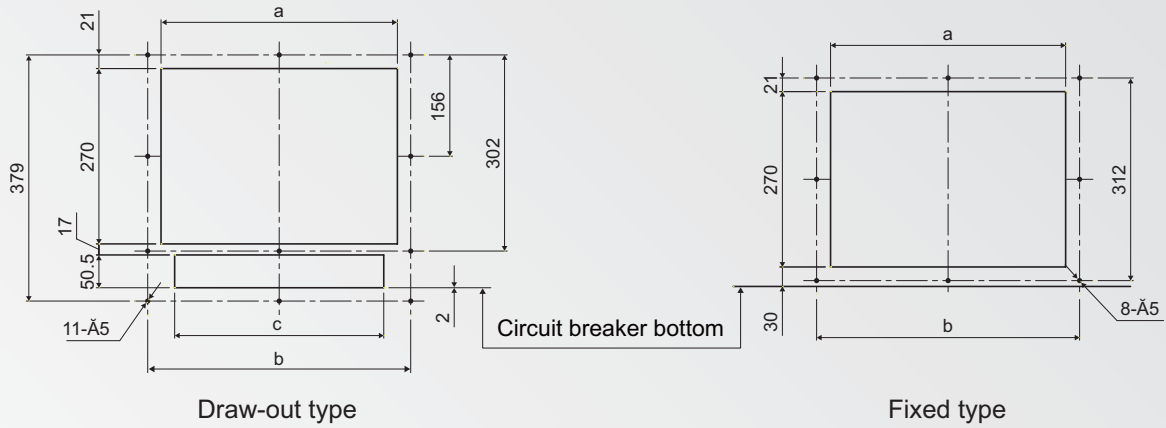

Draw-out type

Fixed type

Inm/A	a (mm)	b (mm)	c (mm)
2000	302	345	262
2500	305	345	265
3200、4000、6300	364	405	322

Inm/A	a (mm)	b (mm)
2000	302	345
3200、4000	362	405

#### Panel hole dimensions

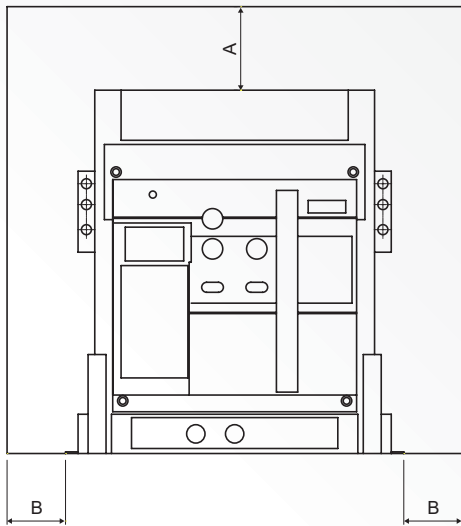

Draw-out type

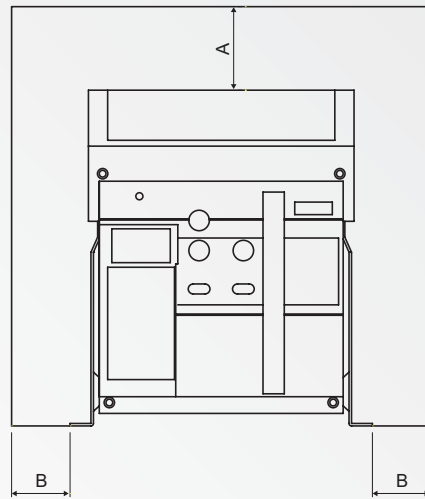

Fixed type

	To the insulated body		To the metal body	
	A	B	A	B
Draw-out type	0	0	0	0
Fixed type	100	30	100	70



## 7.4 Busbar Support

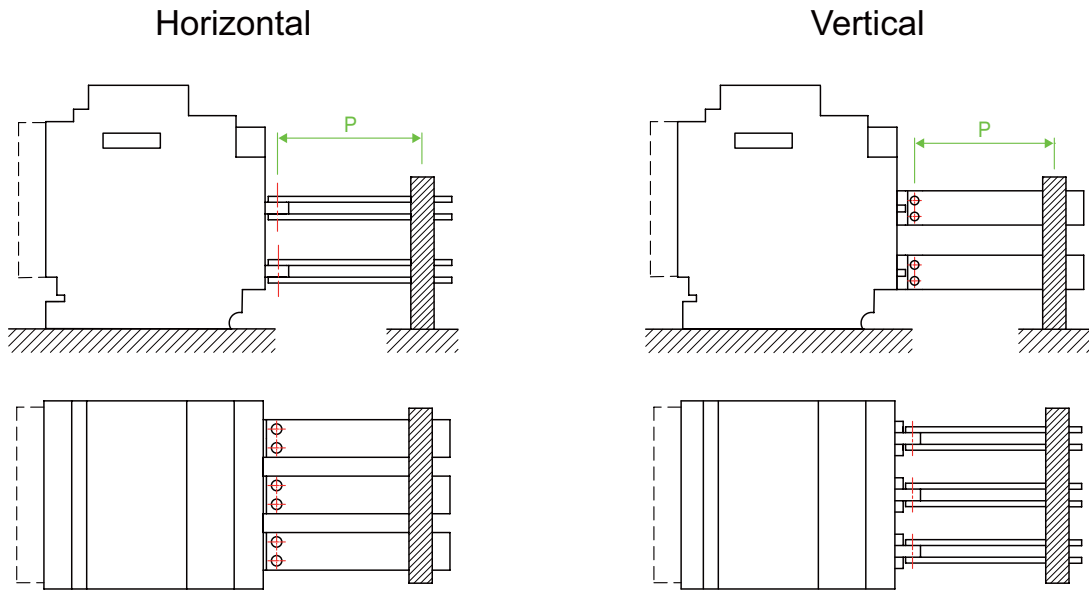

P	BW2000	BW3200 ~ BW6300
Level	250	150
Horizontal	250	—

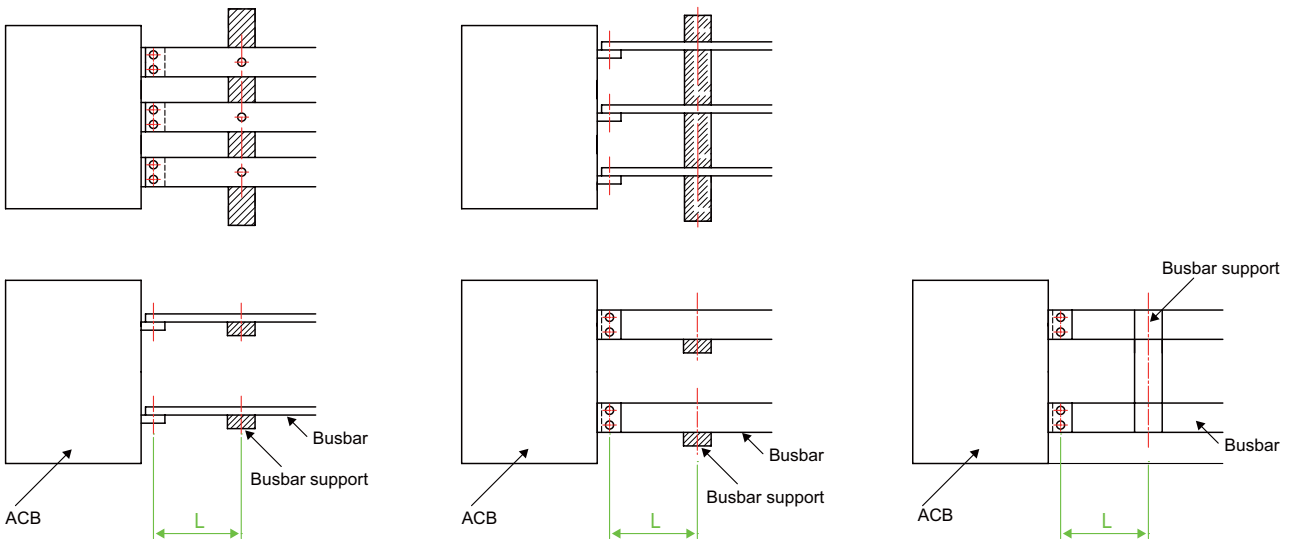

Horizontal terminals

Vertical terminals

Vertical terminals

The maximum distance of the connection point of acb to the first busbar support

Short-circuit current(kA)		30	50	65	80	100	120
Short-circuit L(mm)	BW2000AF	350	300	250	150	—	—
	BW3200AF	350	300	250	150	150	—
	BW4000AF	350	300	250	150	150	—
	BW6300AF	350	300	250	150	150	150

## 8. Mounting, Usage, and Maintenance

### 8.1 Mounting

- (1) Before mounting, check the specifications of the circuit breaker to make sure if they meet the requirements.
- (2) Before mounting, check the insulator resistance with a 500V megger. The resistance should not be less than 10MΩ when the surrounding medium temperature is 20°C+5°C with a relative humidity between 50% and 70%. If not, please dry it until the insulator resistance satisfies the requirements.
- (3) The base of the breaker should be installed horizontally and fixed by M10 screws.
- (4) Circuit breakers should have reliable ground fault, and the ground fault points should be clearly marked. Fixed-type circuit breakers should strictly follow safe distance regulations.
- (5) After mounting a circuit breaker according to the wiring diagram, the circuit breaker should be tested for the following matters before the main circuit is powered (for a drawer-type of circuit breaker, follow the instructions on the cradle for testing).
  - a. Check if the under-voltage, shunt release and closing electromagnet have well matched electric motor operation voltage (the breaker cannot be operated unless the under-voltage release is closed).
  - b. Energy-storage will be indicated after flipping the handle on the cover seven times. When hearing a click sound, energy storing is completed. Press the closing button or turn off the electromagnetic switch to securely close the circuit breaker. Flip the handle again to start energy storage.
  - c. Turn on the power of electric motor energy storage device and "energy storage" will be displayed. There will be a click sound when energy storage is completed. The motor will be turned off automatically. Press the "closing" button or closing the electromagnetic switch for closing the circuit breaker reliably.
  - d. When the breaker is closed in a tripping test (See 8.2.3d), the circuit breaker should be tripped by the tripping button of under-voltage or the release shunt or the tripping button on the cover.

### 8.2 Intelligent Controller Usage

#### 8.2.1 Panel Schematic Diagram

A panel schematic diagram is shown on the right:

##### a. Introduction

The display panel of XSIC intelligent controller can be divided into four regions:

LCD screen, keyboard, knob, and LED status indicator.

For details, please refer to the panel diagram.

The LCD, the keyboard, and the knob are used in combination depending on the condition.

During the operation of the intelligent controller, all the parameters setting will be displayed, including the following:

\* Voltage/current measurement, setting, fault data, etc.



**b. LED Status Indicator**

The working status indicator is used to notify the current working conditions of the circuit breaker. It includes the following:

- ① BUS (Communication indicator):  
 BUS light will be on when controller is receiving and sending data via test port.  
 This communication light is only available for controllers with a communication function.
- ② RUN:  
 When run light is on, the controller is run.
- ③ Trip:  
 When Trip (tripping indicator) light is on, the controller has detected circuit breaker tripped.
- ④ Fault alarm (PAL):  
 Delay protection will be carried out when there is overload, short circuit, Ground Fault / Earth Leakage and so on.
- ⑤ TAL (system failure alarm):  
 TAL light will be on when the controller detects overheating, tripping fault, low contact wear rate, etc.

**8.2.2 HMI Instruction**

The controller buttons includes a menu key, a downward key, an enter key, and a return key. See the figures below.

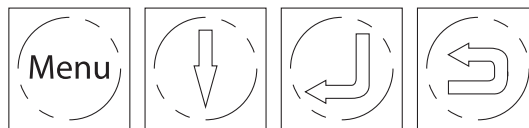

The controller's HMI provided 6 main menus and 1 default interface.

**a. The default interface**

The screen shows the system current status.

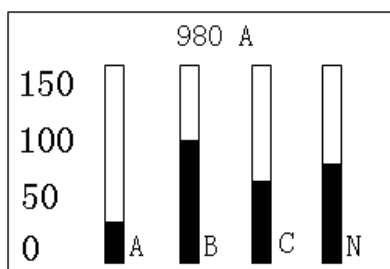

- ◆ When the controller is turned on, the screen will show the default interface.
- ◆ It will show the maximum current on each phase
- ◆ Without press any button and fault, the default interface will be return automatically within a minute.

**b. Menu interface**

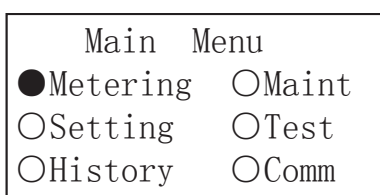



- ◆ Press to jump to the menu interface.
- ◆ Press followed by to alter the corresponding sub-interface.
- ◆ Press to return to the default interface.

## c. Metering interface

Metering:

- Current
- Unbal. I
- Voltage



◆ Press  followed by  to alter the corresponding sub-interface.

◆ Press  to return to the menu interface.

## d. Parameter interface

Setting:

- Curve
- Knob Para
- Other Para
- Prog Contact



◆ Press  followed by  to alter the corresponding sub-interface.

◆ Press  to return to the menu interface.

## e. History interface

History:

- Trip-Records
- Self-Diagnosis



◆ Press  followed by  to alter the corresponding sub-interface.

◆ Press  to return to the menu interface.

## f. Maintenance interface

Maint:  Password

- Date-Time
- System Info
- Language



◆ Press  followed by  to alter the corresponding sub-interface.

◆ Press  to return to the menu interface.

## g. Communication interface

Comm:  Local | Remote

- Protocol
- Address
- Baudrate

◆ Press  followed by  to alter the corresponding sub-interface.

◆ Press  to return to the menu interface.

### 8.2.3 Setting, Query, Testing Methods and System Clock Setup

#### a. Parameter query and setup methods

##### (1) Parameter interface



Setting:

Curve

Knob Para

Other Para

Prog Contact

- ◆ Main Menu → Setting
- ◆ Press  followed by  to alter the corresponding sub-interface.
- ◆ Press  to return to the upper-level interface.



##### (2) Knob parameter interface:

Knob:       Overload

Short

Instant

Ground  
(Leakage)

- ◆ Main Menu → Setting → Knob Para
- ◆ Press  followed by  to alter the corresponding sub-interface.
- ◆ Press  to return to the upper-level interface.

##### (3) Overload parameter interface: (The interfaces for short-circuit, instantaneous tripping and ground fault are similar to this interface.)

Overload:

Ir= 2000A

Tr= 20.0s

- ◆ Main Menu → Setting → Knob Para → Overload
- ◆ Displaying the present set values for overload (For displaying only; if setting up values is required, use the knob).
- ◆ Press  to return to the upper-level interface.



##### (4) Setting up the parameter interface

Other:     Load Monitor

Thermal Mem

Open-Phase

Protect.N

- ◆ Main Menu → Setting → Other Para
- ◆ To enter the interface, enter the authorization password.
- ◆ Press  followed by  to alter the corresponding sub-interface.
- ◆ Press  to return to the upper-level interface.

##### (5) Load monitoring setting up interface







Load Monitor

ON       OFF

TYPE1    TYPE2



Ic1= 0.8Ir= 800A

Ic2= 0.5Ir= 500A

- ◆ Main Menu → Setting → Other Para → Load Monitor
- ◆ The default is the present set value.
- ◆ Press  to set up the ON/OFF of the load monitoring function.
- ◆ Press  to confirm the change and enter the the setup of the load monitoring protection method.
- ◆ Press  to set up the method of load monitoring function.
- ◆ Press  to confirm the change and enter the setup for IC1 protection factor.
- ◆ Press  to adjust the protection factor of IC1 and IC2.
- ◆ Press  to confirm the change.
- ◆ Press  to return to the upper-level interface.





## (6) Thermal memory setting up interface

Thermal Memory
<input checked="" type="radio"/> ON
<input type="radio"/> OFF

- ◆ Main Menu → Setting → Other Para → Thermal Mem
- ◆ The default is the present set value.
- ◆ Press  to select the ON/OFF of thermal memory.
- ◆ Press  to confirm the change.
- ◆ Press  to return to the upper-level interface.



## (7) Open-phase protection setting up interface

Open-Phase
<input checked="" type="radio"/> ON <input type="radio"/> OFF
Iunbal = 90.0%
Tunbal = 10.0s

- ◆ Main Menu → Setting → Other Para → Open-Phase
- ◆ The default is the currently set value.
- ◆ Press  to set up the ON/OFF of the under-phase protection function.
- ◆ Press  to confirm the change.
- ◆ Press  to adjust Iunbal or Tunbal.
- ◆ Press  to confirm the change.



## (8) N-phase protection setting up interface

Protect.N
<input checked="" type="radio"/> 50%
<input type="radio"/> 100%
IrN = 1000A

- ◆ Main Menu → Setting → Other Para → Protect.N
- ◆ The default is the currently set value.
- ◆ Press  to select 50%/100% protection of N-phase.
- ◆ Press  to confirm the change.
- ◆ Press  to return to the upper-level interface.

## (9) Programmable contact point setup interface

1. Remote Open
2. Remote Close
3. Monitor.1
4. Monitor.2



- ◆ Main Menu → Setting → Prog Contact
- ◆ To enter the interface, enter the authorization password.
- ◆ The default display is the present set value.
- ◆ Press  to adjust the present programmable contact functions.
- ◆ Then press  to confirm the change and to enter the next contact point.
- ◆ Function setup
- ◆ Press  to return to the upper-level interface.

Note: If the controller has a communication function, Contact 1 and 2 cannot be set but fixed to remote opening and remote closing.  
When the load monitoring function is ON, contact 3 and 4 cannot be set but fixed to monitor 1 and 2.

**b. Query and adjustment of relevant system parameters**



(1) Maintenance interface

Maint: ● Password  
 ○ Date-Time  
 ○ System Info  
 ○ Language

- ◆ Main Menu → Maint
- ◆ Press  followed by  to alter the corresponding sub-interface.
- ◆ Press  to return to the upper-level interface.

(2) Password change interface

Enter Password:  
 0XXX

- ◆ Press  to adjust the present password digit.
- ◆ Press  to confirm the changed password digit and enter to the next password digit for setup.
- ◆ Press  to return to the upper-level interface.

(Enter correct old password)



Enter New Password:  
 0XXX

New Password Again:  
 0XXX

(3) Clock calibration interface



Date: 12. 11. 01  
 Time: 09:22:30  
 SET

(Clock checking conditions)

- ◆ Main Menu → Maint → Date-Time
- ◆ Under the condition, the system will display the present time.
- ◆ Press  and the term "calibration" will be highlighted.
- ◆ Press  again to confirm clock calibration.
- ◆ The password interface will pop out. Enter the correct password to enter the clock calibration state.



Date: 12. 11. 01  
 Time: 09:22:30  
 SET

(Clock calibration state)

- ◆ Press  to adjust the year.
- ◆ Then press  to confirm the change and to correct the month.
- ◆ Use the above method to set up the year, month, day, hour, second, and second.

(4) Contact wear indication interface

Contact Wear  
 Remainder: 99%  
 Reset

- ◆ Main Menu → Maint → System Info → Contact Wear
- ◆ The default is the present contact worn amount.
- ◆ Press  and the term "reset" will be highlighted.
- ◆ Then press  to confirm to enter contact worn reset operation.
- ◆ The password interface will pop out. Enter the correct password to reset the contact worn amount to 100%.

(5) Controller parameter interface



Controller	
Type:	XSIC-A4G1
In:	1000A
Date:	12. 11. 01

- ◆ Main Menu → Maint → System Info → Controller
- ◆ Display relevant parameters of the present controller.
- ◆ Press  to return to the upper-level interface.

c. Historical record inquiry

(1) Tripping record interface

01/10:	2
Ia=2000A	
Ib=1000A	Ir=
Ic=1000A	Tr=
In=1000A	
<b>Over load. A</b>	I=2000A
	T=19.9s

- ◆ Main Menu → History → Trip-Records
- ◆ It will display the ten latest tripping fault cases recorded. The figure on the left displays the latest tripping recorded.
- ◆ Press  to review tripping cases 1 to 10 in the record.
- ◆ Press  to return to the upper-level interface.

(2) Self-diagnose record interface

01/10:	
	12. 11. 01
	20: 15: 20
Diag. Cause:	G
Diag. Para :	2000A



- ◆ Main Menu → History → Self-Diagnosis
- ◆ It will display the ten latest self-diagnose cases recorded. The figure on the left displays the latest self-diagnose case recorded.
- ◆ Press  to review self-diagnose cases 1 to 10 in the record.
- ◆ Press  to return to the upper-level interface.

Table 8: Self-diagnose fault codes

Type of diagnosis	L	S	I	G	E	P	T	M
Diagnostic parameters	Fault current	Fault current	Fault current	Fault current	Fault current	Current unbalance rate	>70°C	<40%
Meaning	Overload-caused no operation	Short-circuit caused no operation	Instantaneous tripping caused no operation	Ground fault caused no operation	Earth Leakage caused no operation	Open-Phase caused no operation	Overheat ed environment	Contact wear

(3) Alarm reporting record interface: Reserved



**d. System testing operation**

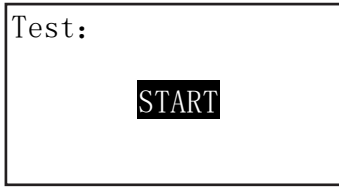



- ◆ Main Menu → Test
- ◆ Press  to confirm to testing operation.
- ◆ The password interface will pop out. Enter the correct password and the system will send a tripping signal for testing.

**e. Communication parameter setup (for XSIC-P type of controller only)**

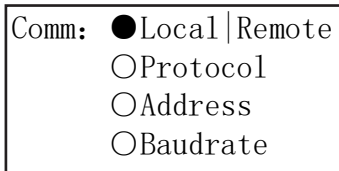

(1) Communication parameter interface

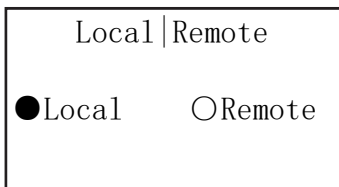

- ◆ Main Menu → Comm
- ◆ To enter the interface, enter the authorization password.
- ◆ Press  followed by  to alter the corresponding sub-interface.
- ◆ Press  to return to the upper-level interface.

(2) Local/remote setup interface



- ◆ Main Menu → Comm → Local|Remote
- ◆ The default is to display local or remote condition.
- ◆ Press  to select the corresponding sub-item and press  for confirmation.
- To make any change:
- ◆ Press  to return to the upper-level interface.



(3) Communication protocol interface: The operation is the same as the operation of local/remote setup interface.

(4) Communication baud rate interface: The operation is the same as the operation of local/remote setup interface.

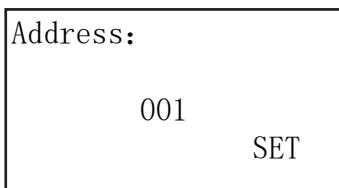
(5) Communication address setup interface



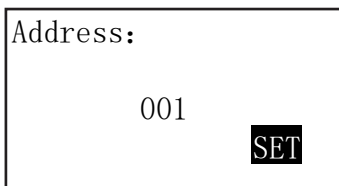

(Communication address check state)

- ◆ Main Menu → Comm → Address
- ◆ The default display is the present communication address.
- ◆ Press  and the term "change" will be highlighted.
- ◆ Press  to confirm the action for changing the communication address.



(Communication address change state)

- ◆ Press  to adjust the present position.
- ◆ Press  to confirm the action for adjusting the present position.
- ◆ Repeat the above two steps until the three digits have been changed and completed. The system is now ready to change the communication address.
- ◆ Press  to return to the upper-level interface.

### 8.3 Instruction of draw in/out of ACB main body

#### ■ Draw in

Pull out the left/right saddles on the cradle and put the main body onto the saddle. Push the saddle into the cradle and turn the handle (at the bottom left of the cradle) clockwise. The main body will be pushed from the disconnect position through the test position to the connected position. Once the main body has reached the connected position, there will be two click sounds, indicating that the main body has reached the designated position.

#### ■ Draw out

When the main body is at the connected position, turn the handle counterclockwise to pull out the main body. When the indicator is pointing toward the "disconnect" position, pull out the handle and then use the saddle to withdraw the main body from the cradle. (If the saddle is not pulled out, the main body can not be withdrawn.) Take the handle at the two sides of the circuit breaker to remove the main body from the cradle.

Before inserting the main body into the cradle, the circuit breaker has to be at the "disconnected" position. Put the main body to the testing position. Once the secondary circuit is connected, testing can be carried out.

### 8.4 Maintenance

■ Clean dust routinely to keep circuit breaker insulation good.

■ Routinely apply lubricating oil (at the bearings) and the lubricating grease (at the gears and other slide components).

■ Routinely check the contact system and mechanisms.

a) Check the arc-extinguishing chamber and the wear state of the contact. If necessary, it is important to measure the opening distance and contact over-travel. For measuring the over travel, the user can check the size of displacement of the moving contact arc angle in relation to the support of the contact by marking on the contact sustainer (at the moving contact arch angle) when the circuit breaker is at the closing state. Then break the circuit breaker to measure the displacement of the moving contact head on the contact support. The contact over travel is the product of the measured displacement and 28/53. The value should be greater than 4mm.

b) Check if the fastened components are well fixed. Make sure that the components will not fall down or become invalid.

c) Check if the tripping travel of under-voltage release, shunt release, or closing electronic magnet has surplus or not. If the over travel of the closing electromagnet is about 1mm, the rest has to be greater than 1mm.

d) Check the operation characteristics of all accessories to see if they meet the required characteristics.

e) Use a 1mm-thick strawboard or other materials to fill in the gap between the moving and the fixed contacts. The breaker should be able to carry out closing reliably. Be careful when adding the strawboard.

■ To reach the mechanical life without maintenance, it is important to renew the electric energy-storage machine, main contacts, and the spring of the energy-storage machine.

■ Checking after short-circuit tripping: The checking method is the same as the one mentioned above. In addition, there should be no obvious damage at the soft connection or the welding part.

Replace the damaged parts. When the circuit breaker has reached its electrical lifespan, change the arch extinguishing chamber and the contact system on time.

## 9. Commonly Observed Faults and Trouble-shooting

Serial number	Problems	Possible causes	Troubleshooting
1	circuit breaker can not be closed	<ol style="list-style-type: none"> <li>1. The under-voltage release has no current/voltage. Or it is not connected</li> <li>2. After intelligent release generates tripping, the red button on the controller panel is not reset.</li> <li>3. The operation machine has no energy storage.</li> </ol>	<ol style="list-style-type: none"> <li>1. Check the wiring, and turn on the power of the under-voltage release.</li> <li>2. Press the reset button.</li> <li>3. Choose manual operation (Energy-storage opened after flipping up and down the handle on the panel seven times.) When you hear the click sound, energy storage is completed. The user can also use the electric method for the machine to store energy.</li> </ol>
2	No circuit breaker electric power energy storage.	<ol style="list-style-type: none"> <li>1. Power of the electric operation machine is not on.</li> <li>2. Insufficient power capacity</li> </ol>	<ol style="list-style-type: none"> <li>1. Check the wiring, and turn on the power.</li> <li>2. Check if the operating voltage is greater than 35% U<sub>e</sub>.</li> </ol>
3	The closing electromagnet cannot make the circuit breaker close.	<ol style="list-style-type: none"> <li>1. Power off/no voltage</li> <li>2. Insufficient power capacity</li> </ol>	<ol style="list-style-type: none"> <li>1. Check the wiring, and turn on the power.</li> <li>2. Check if the operating voltage is greater than 35% U<sub>e</sub>.</li> </ol>
4	No circuit breaker closing by the closing electromagnet	<ol style="list-style-type: none"> <li>1. Power off/no voltage</li> <li>2. Insufficient power capacity</li> </ol>	<ol style="list-style-type: none"> <li>1. Check the wiring, and turn on the power.</li> <li>2. Check if the operating voltage is greater than 70% U<sub>e</sub>.</li> </ol>
5	Instantaneous tripping happens even though the fault current does not exceed the short-delay.	Inappropriate short-delay time or instantaneous tripping value.	Inappropriate setup; Reset according to the principle of $I_{sd} > I_r$ .
6	Frequent circuit Breaker tripping	The overload protection tripping is caused by on-site overloading. Because the overload thermal memory fails to immediately turn off the power and clear, reclosing happens again.	Turn off the controller once or re-close the breaker 30 minutes later.
7	Drawer-type Circuit Breaker handle cannot be inserted into the circuit breaker.	The track of the cradle or the circuit breaker itself is not pushed in completely.	The track or the circuit breaker has to be pushed all the way to the end.
8	Circuit breaker cannot be pulled out from the body of drawer-type circuit breaker at "disconnected" position	<ol style="list-style-type: none"> <li>1. The handle was not pulled out completely.</li> <li>2. The circuit breaker was not completely disconnected.</li> </ol>	<ol style="list-style-type: none"> <li>1. Pull out the handle.</li> <li>2. Make the circuit breaker to the "disconnected" position completely.</li> </ol>



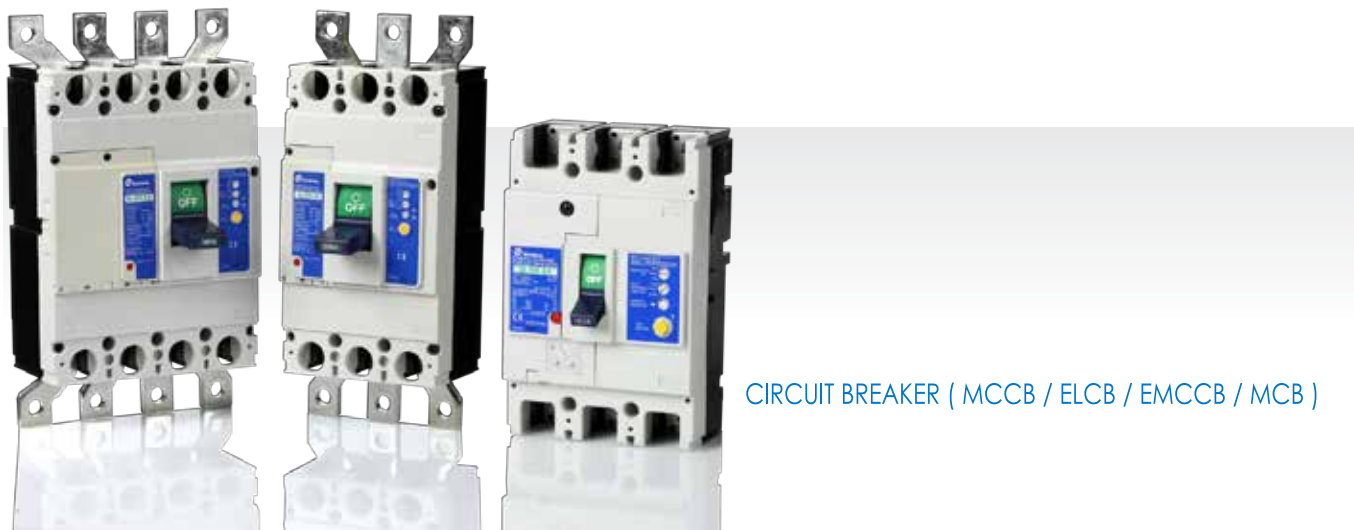

CIRCUIT BREAKER ( MCCB / ELCB / EMCCB / MCB )

## Breaker & Switchgear System



AIR CIRCUIT BREAKER

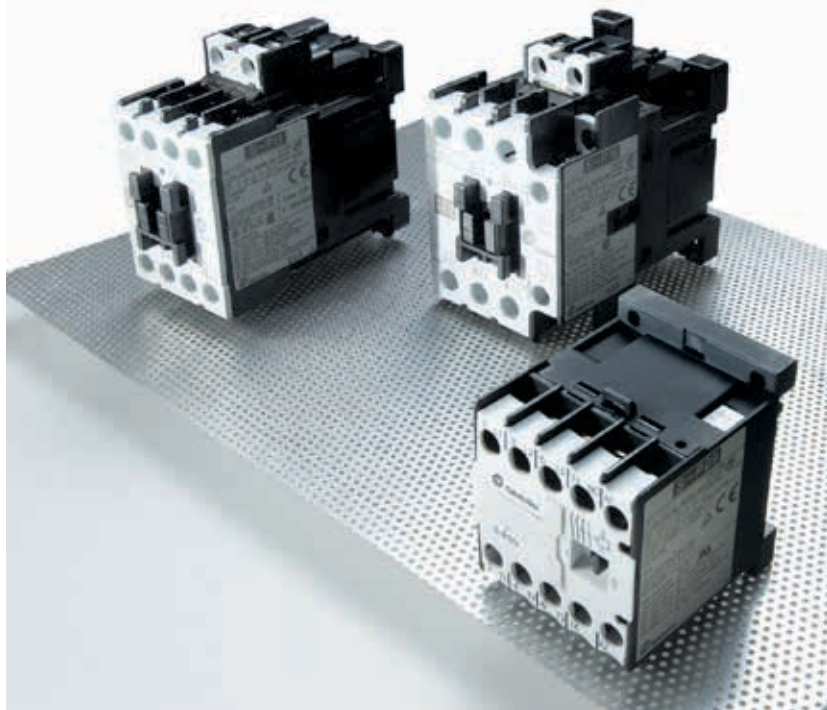

MAGNETIC CONTACTOR / SWITCH ( CONTACTOR / MS / MMS )



AUTOMATIC TRANSFER SWITCHES



SURGE PROTECTIVE DEVICE



SMART METER



INVERTER



LOW VOLTAGE POWER CAPACITORS



# SHIHLIN ELECTRIC & ENGINEERING

MOTOR CONTROL (CONTACTOR/ MS/ MMS), CIRCUIT BREAKER (MCCB/ ELCB/ EMCCB/ MCB), AIR CIRCUIT BREAKER, AUTOMATIC TRANSFER SWITCHES (Panel Board Type/ Residential Unit Use), SURGE PROTECTIVE DEVICE, LOW VOLTAGE POWER CAPACITORS, SMART METER, INVERTER



## **Breaker & switchgears overseas sales dept.**

3F, No.9, Sec. 1, Chang-an E. Rd., Zhongshan Dist., Taipei City 10441, Taiwan

T. +886-2-2541-9822 F. +886-2-2581-2665

e-mail. [b.export@seec.com.tw](mailto:b.export@seec.com.tw)

<http://circuit-breaker.seec.com.tw>

## **Headquarter**

16F, No.88, Sec. 6, Zhongshan N. Rd., Shilin Dist., Taipei City 11155, Taiwan

T. +886-2-2834-2662 F. +886-2-2836-6187

<http://www.seec.com.tw>

Distributor

B220304.ACB-KEMA-OB