

# BKL Dimension (mm)

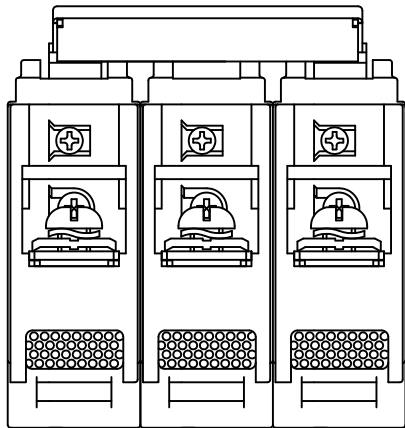

3P

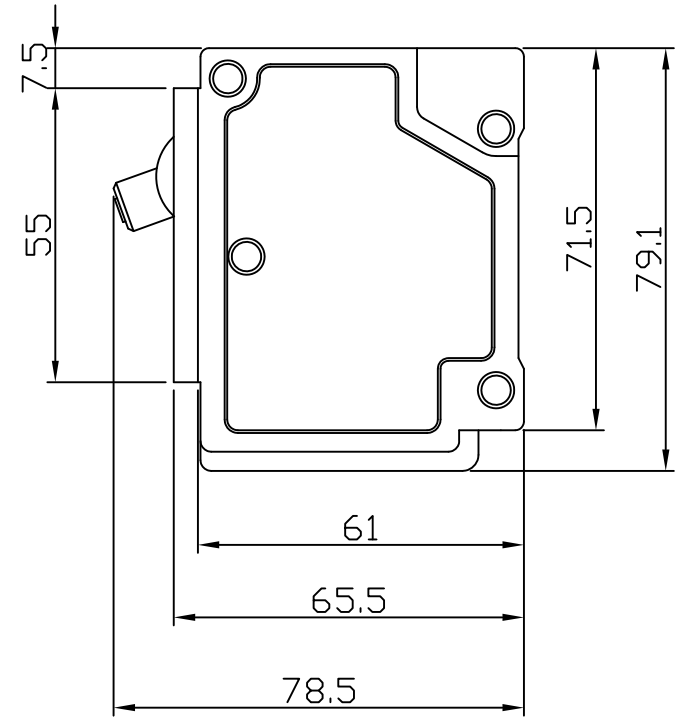
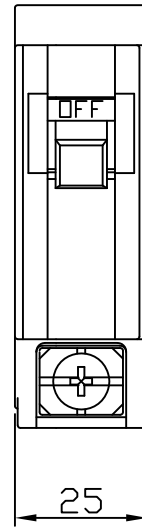
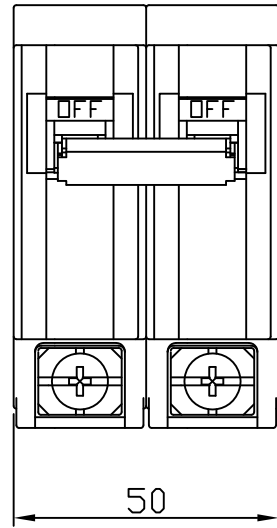
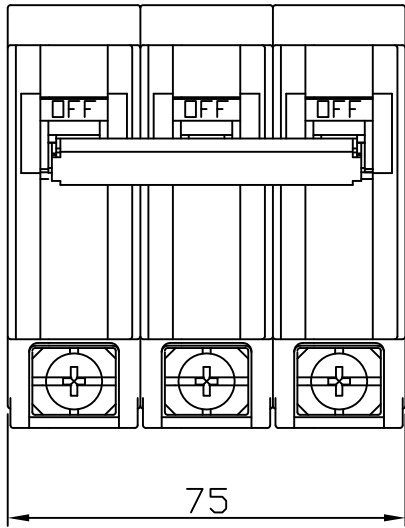
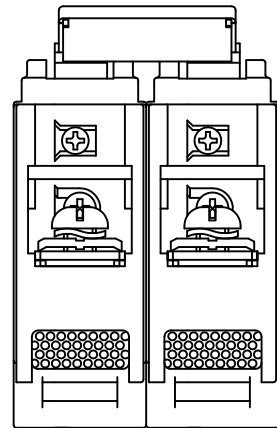

2P

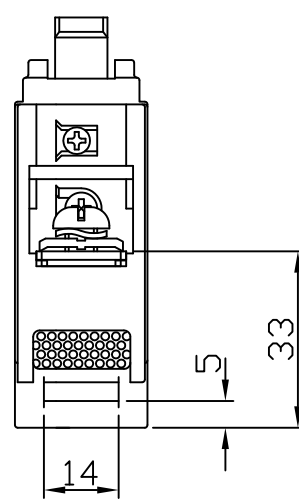

1P