

# BP, BPH Dimension (mm)

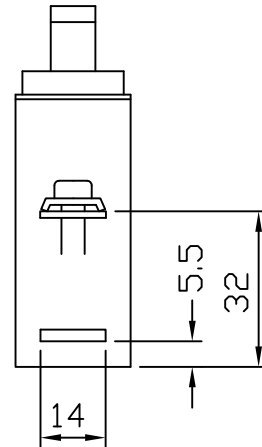
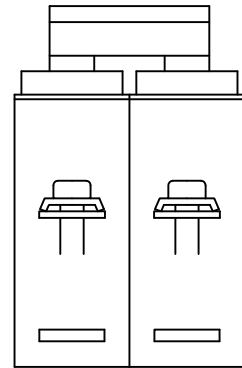
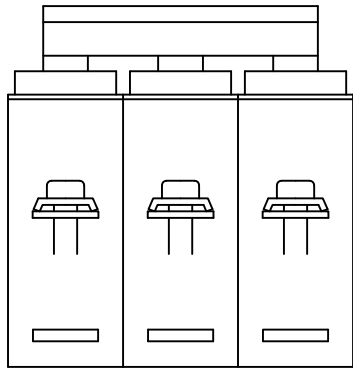
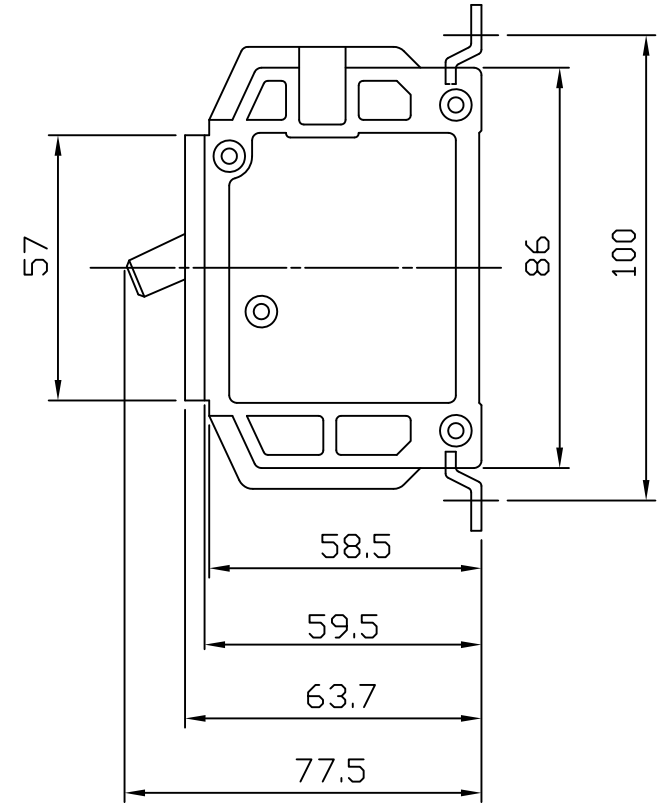
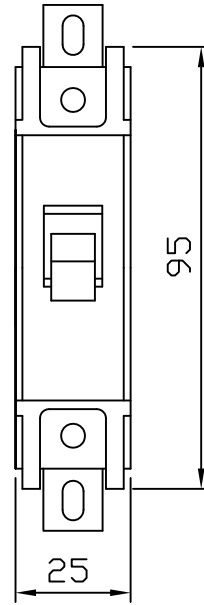
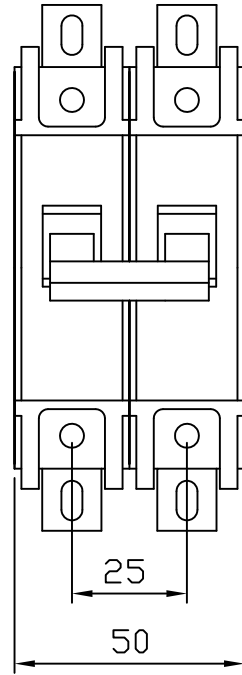
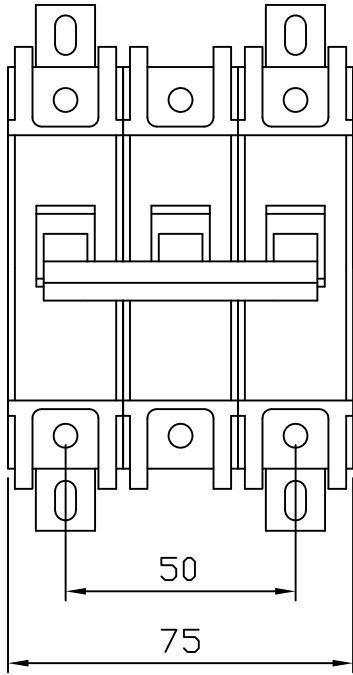

3P

2P

1P