

1600A

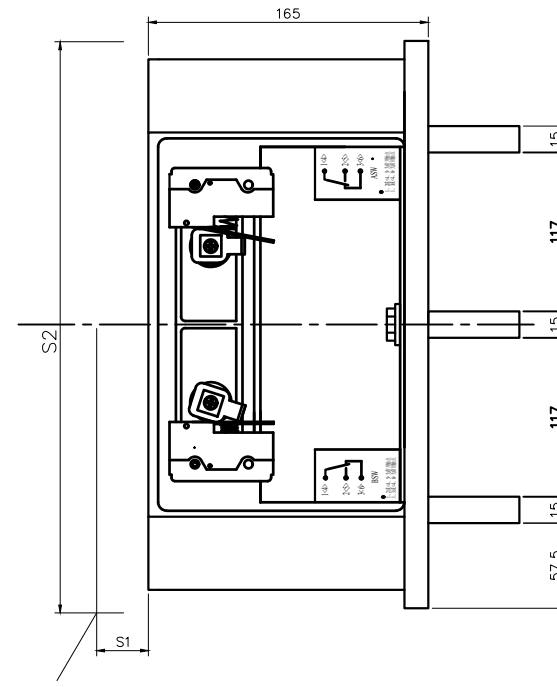
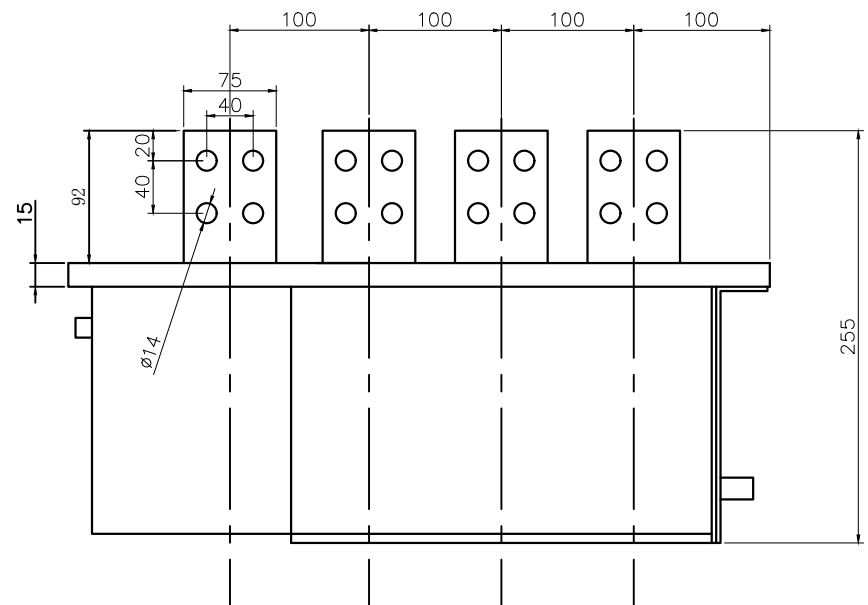
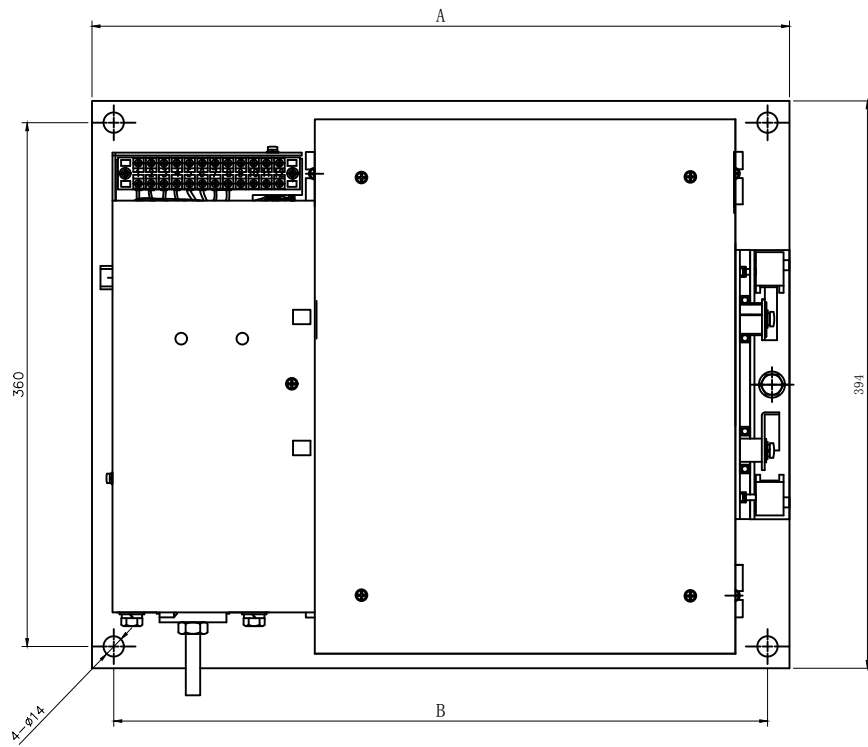

Safety distance

Unit (mm)	Ue	400V	690V
S1		45	90
S2		430	450

	A	B
3P	515	480
4P	615	580