



MAGNETIC CONTACTOR & MOTOR STARTER



P Series



Functionalities and characteristics of Magnetic Contactor

• Configuration

Composite magnetic switch (abbreviated as MS) is comprised of a contactor for switching on and off current and a thermal overload relay for protecting the load.

• Functions

- Switching the control system for electric power transmission and distribution.
- Operation of the start and stop of motors.
- Electric power control for all kinds of industrial machinery, machine tools, injection molding machines.

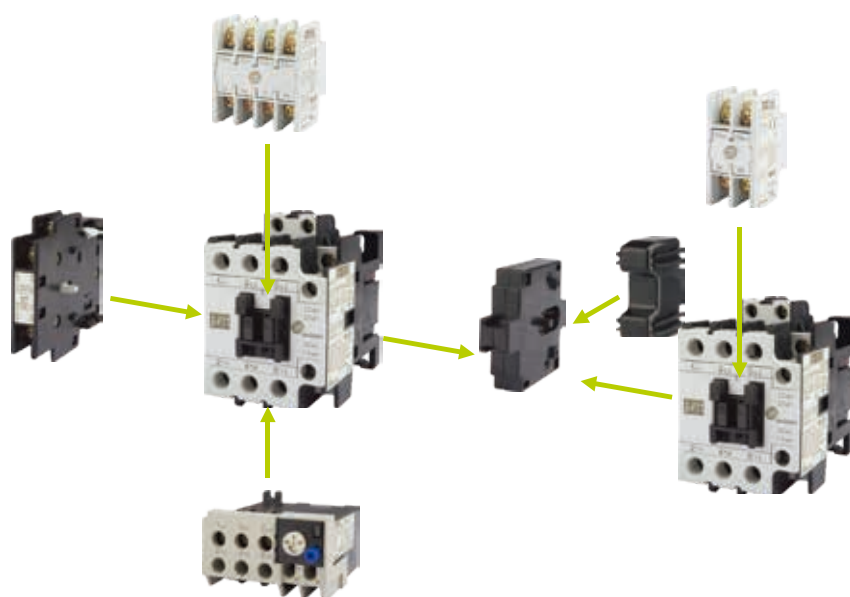

• Feature

- Products comply with multiple international standards.
Compliant standards: JIS, JEM, IEC, EN, VDE
Certificate: UL, UR, CSA, TUV, CE
- Auxiliary Contact Block designed for installing on the front and on the side can satisfy the spatial requirements of different operating environments.



AP-2P
(1NO 1NC, 2NO, 2NC)

AP-4P
(2NO 2NC 4NO, 3NO 1NC)

APS-11
(1NO 1NC)

Charact-eristics

SP

Series

MS

Series

Other

Series

Coil

TH

Series

SD

Series

Selec-tion

Others

c. Increase the reliability of auxiliary contacts (S-P60T and lower).

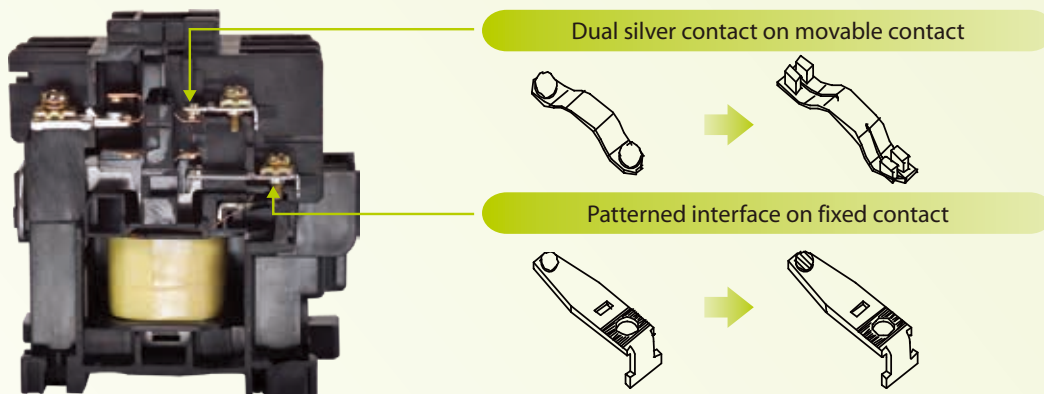

Notes:
Apply the above auxiliary terminal design can increase the reliability of the contacts and minimize the contact resistance variation.

● Descriptions of product characteristics S-P300 · S-P400

Category	Product features
Usability	<ul style="list-style-type: none"> • Energy saving design with low power consumption for operating coils and operating VA capacity. • Operating coils apply common AC/DC power, AC or DC operation, DC holding, absolutely free of electromagnetic noise. • Wide range of operating voltage 100-240V, 265-450V, 440-575V, ease of customer use.
Internationalization	<ul style="list-style-type: none"> • Compliant with IEC, CE, UL, TUV worldwide standards.
Safety	<ul style="list-style-type: none"> • Spaced safety partition design: prevent short-circuit accidents caused by falling foreign objects. • Safety trip mechanism design: when main contact melts down, auxiliary NC contact will break apart and open. • Trip indication safety mechanism design: prevent external forces or human faulty activation which could lead to false function that bring about danger. • Highly voltage drop withstand coil design (prevent the motor from starting at insufficient voltage [$<65\%U_s$ is not allowed to activate]).
Others	<ul style="list-style-type: none"> • Contact material does not contain cadmium, which complies with RoHs requirements

Characteristics

SP

Series

MS

Series

Other

Series

Coil

TH

Series

SD

Series

Selection

Others

Description of thermal overload relay

- **Automatic temperature compensation design**

Bi-metal design can adjust and compensate automatically for ambient temperature changes, which increase the reliability of the product.

- **Single unit installation base can be added for independent use**

TH-P12, TH-P18 can be installed to single unit installation base, which can be used independently on the track or be fixed on the installation plate.

- **Safety terminal cover design for high safety level**

Terminal cover, is easy to install and complies with IEC degree of protection of IP 20.

- **Auxiliary terminal of thermal overload relay is 1NO 1NC**

The auxiliary contact are designed independently, which can be used for the control of two different power sources and are convenient for wiring.

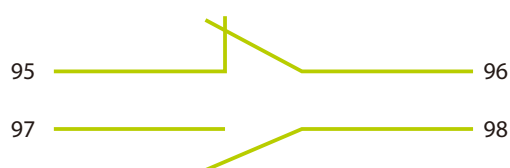

- **Thermal overload relay reset/trip indicator can be seen easily and clear**

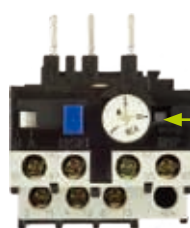

(Reset state)
White rod will appear in the indicator window.

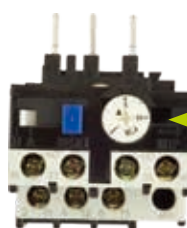

(Trip) White rod shifted and unable to be seen directly.

- **Switching of thermal overload relay between manual/automatic reset is easy (customers can switch by themselves according to their needs)**

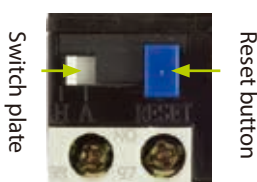

Switch plate

Reset button

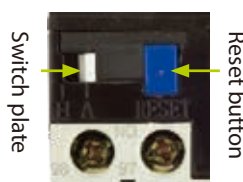

Switch plate

Reset button



Reset button



Reset button

TH-P12

Manual → Automatic reset switching method

Press reset button down and hold it; in the meantime, pull switch plate to the right to position "A" to lock reset rod and keep it in pressed down state, which then becomes the automatic reset state.

Automatic → Manual reset switching method

Pull switch plate to the left to position "H" to have reset rod recoiled back upward and finish.

TH-P20~TH-P600

Manual → Automatic reset switching method

Use cross screwdriver and align it with the cross hole on the top of reset button, engage and drive the button rotating it 90° counterclockwise to have the arrow points from "H" to "A" and keep reset button in pressed down state.

Automatic → Manual reset switching method

Use cross screwdriver and align it with the cross hole on the top of reset rod, engage and drive the rod rotating it 90° clockwise to have the arrow points from "A" to "H" and the reset rod recoiled back to its original position.

Characteristics

SP

Series

MS

Series

Other

Series

Coil

TH

Series

SD

Series

Selection

Others

MS | S-P Series

MS | S-P Series

Type designation



S-P21



S-2xP30T

MS | MS-P Series

Type designation



MSO-P11



MSO-2xP11



MS-P11PB



MS-2xP11

S	-	2x	P	35T	220V
1		2	3	4	5

1	Model
	S : AC Magnetic contactor
2	Non-reversing/reversing
	Blank Non-reversing
	2x Reversing
3	Series
	P P Series
4	Rated capacity
	9T、11、12T、15、16、21、25、30T、32T、35T、38T、40T、50T、60T、80T、100T、125T、150T、200T、220T、300T、400T、600
5	Control circuit voltage
	EX. 110V、220V、380V、440V (Refer to P34)

MS	-	2x	P	35T	PB	380V/	220V	28A	E
1		2	3	4	5	6	7	8	9

1	Model
	MSO AC Magnetic contactor without enclosure
	MS AC Magnetic contactor with enclosure
2	Non-reversing/reversing
	Blank Non-reversing
	2x Reversing
3	Series
	P P Series
4	Rated capacity
	9T、11、12T、15、16、21、25、30T、32T、35T、38T、40T、50T、60T、80T、100T、125T、150T、200T、220T、300T、400T、600
5	Push button
	Blank Non- Push button type
	PB With Push button type (MSO model is without PB)
6	Main circuit voltage
	EX : 110V、220V、380V、440V (When main circuit voltage and control circuit voltage are the same, it will be blank.)
7	Control circuit voltage
	EX : 110V、220V、380V、440V... (Refer to P34)
8	TH heater rated capacity
	EX : 3.3A、6.5A、9A、11A、15A...350A...
9	TH Type
	Blank Compressor Type (2 heaters)
	E 3 heaters
	PP Differential Type

Magnetic Contactor / Starter ♦ AC control



Model		9T	11	12T		
Type	Magnetic Contactor	Nonreversing	S-P9T	S-P11	S-P12T	
		Reversing	S-2XP9T	S-2XP11	S-2XP12T	
	Motor Starter	without enclosure	Nonreversing	MSO-P9T	MSO-P11	MSO-P12T
			Reversing	MSO-2xP9T	MSO-2XP11	MSO-2xP12T
		with enclosure	Nonreversing	MS-P9T	MS-P11	MS-P12T
			Reversing	MS-2xP9T	MS-2XP11	MS-2xP12T
		with enclosure (push button)	Nonreversing	MS-P9TPB	MS-P11PB	MS-P12TPB
		TOR	Standard	TH-P12ES	TH-P12ES	TH-P12ES
Differential	TH-P12ES PP		TH-P12ES PP	TH-P12ES PP		
Rated Capacity	IEC 60947-4-1 EN 60947-4-1 DIN VDE 0660	3 Ø	240V	2.5/3/11	3.5/ 4.5/ 13	3.5/4.5/13
			380/415V	4/5.5/9	5.5/ 7.5/ 12	5.5/7.5/12
			440V	4/5.5/9	5.5/ 7.5/ 12	5.5/7.5/12
			550V	4/5.5/7	5.5/ 7.5/ 9	7.5/10/12
			660V	4/5.5/6	5.5/ 7.5/ 7	7.5/10/9
	AC 3 (kW/HP/A)	Continuous Current (Ith) AC1 (A)		25	20	25
		Rated insulation voltage (Ui) (V)		AC690	AC660	AC690
	UL 508 CSA-C22.2	1 Ø	100~120V	0.5/9.8	0.5/ 9.8	0.75/13.8
			200~240V	1.5/10	2/ 10	2/12
		3 Ø	200~240V	3/9.6	3/ 9.6	5/15.2
			380~480V	5/7.6	7.5/ 11	7.5/11
			550~600V	7.5/9	10/ 11	10/11
		Continuous Current (Ith) AC1 (A)		25	24	25
	Rated insulation voltage (Ui) (V)		AC600	AC600	AC600	
	NEMA		-	0	-	
Auxiliary Contact	IEC 60947-5-1 EN 60947-5-1 GB14048.4	Contact	Standard	1NO 1NC	1NO	1NO 1NC
			Special	-	1NC	-
			220V	1.6	1.6	1.6
			380V	0.95	0.95	0.95
	AC 15	Continuous Current (Ith) AC1 (A)		16	16	16
		Contact class (UL)		A600 · Q300	A600, P600, Q300	A600 · Q300
Electrical Life AC3		1.6 Mil.	1.6 Mil.	1.6 Mil.		
Mechanical Life		10 Mil.	10 Mil.	10 Mil.		
Operation (Time/Hour)		1200	1200	1200		
Magnetic Contactor	Weight (kg)	0.34	0.33	0.34		
	Appearance Dimensions (W×H×D) (mm)	43×81×86	43×81×83.5	43×81×86		
	Installation dimension (mm)					
Mechanical Interlock		MPU-11	MPU-11	MPU-11		

Characteristics

SP

Series

MS

Series

Other

Series

Coil

TH

Series

SD

Series

Selection

Others

Magnetic Contactor / Starter ◆ AC control



Model		15	16	21 (A)	25	30T		
Magnetic Contactor	Nonreversing	S-P15	S-P16	S-P21 (A)	S-P25	S-P30T		
	Reversing	S-2×P15	S-2×P16	S-2×P21 (A)	S-2×P25	S-2×P30T		
Motor Starter	without enclosure	Nonreversing	MSO-P15	MSO-P16	MSO-P21 (A)	MSO-P25	MSO-P30T	
		Reversing	MSO-2×P15	MSO-2×P16	MSO-2×P21 (A)	MSO-2×P25	MSO-2×P30T	
		with enclosure	Nonreversing	MS-P15	MS-P16	MS-P21 (A)	MS-P25	MS-P30T
			Reversing	MS-2×P15	MS-2×P16	MS-2×P21 (A)	MS-2×P25	MS-2×P30T
	with enclosure (push button)	Nonreversing	MS-P15PB	MS-P16PB	MS-P21PB (A)	MS-P25PB	MS-P30TPB	
	TOR	Standard	TH-P12ES	TH-P20ES	TH-P20ES	TH-P20ES TA	TH-P20ES TA	
		Differential	TH-P12ES PP	TH-P20ES PP	TH-P20ES PP	TH-P20ES TAPP	TH-P20ES TAPP	
	Rated Capacity	IEC 60947-4-1 EN 60947-4-1 DIN VDE 0660 AC 3 (kW/HP/A)	3 Ø	240V	4.5/ 6/ 18	4.5/ 6/ 18	5.5/ 7.5/ 24	6.5/ 8.5/ 26
380/415V				7.5/ 10/ 18	7.5/ 10/ 18	11/ 15/ 21	12/ 16/ 25	15/ 20/ 30
440V				7.5/ 10/ 16	7.5/ 10/ 16	11/ 15/ 21	12/ 16/ 23	15/ 20/ 27
550V				7.5/ 10/ 13	7.5/ 10/ 13	11/ 15/ 17	12/ 16/ 20	15/ 20/ 22
660V				7.5/ 10/ 9	7.5/ 10/ 9	11/ 15/ 14	12/ 16/ 16	15/ 20/ 18
Continuous Current (Ith) AC1 (A)		25	30	32	32	50		
Rated insulation voltage (Ui) (V)		AC660	AC660	AC660	AC660	AC660		
UL 508 CSA-C22.2 AC3 (HP/A)		1 Ø	100~120V	-	1/ 16	2/ 24	2/ 24	2/ 24
			200~240V	-	3/ 17	3/ 17	3/ 17	5/ 28
		3 Ø	200~240V	-	5/ 15.2	7.5/ 22	10/ 28	10/ 28
			380~480V	-	10/ 14	15/ 21	15/ 21	20/ 27
			550~600V	-	10/ 11	15/ 17	15/ 17	30/ 32
Continuous Current (Ith) AC1 (A)		-	30	35	40	50		
Rated insulation voltage (Ui) (V)		-	AC600	AC600	AC600	AC600		
NEMA		0	0	1	1	2		
Auxiliary Contact	IEC 60947-5-1 EN 60947-5-1 GB14048.4 AC 15	Contact	Standard	1NO	1NO 1NC	1NO 1NC (2NO 2NC)	1NO 1NC	2NO 2NC
			Special	1NC	-	-	-	-
			220V	1.6	1.6	1.6	1.6	1.6
			380V	0.95	0.95	0.95	0.95	0.95
	Continuous Current (Ith) AC1 (A)		16	16	16	16	16	
	Contact class (UL)		-	A600, Q300	A600, Q300	A600, Q300	A600, Q300	
Electrical Life AC3		1.3 Mil.	1.3 Mil.	1.3 Mil.	1.3 Mil.	1.3 Mil.		
Mechanical Life		10 Mil.	10 Mil.	10 Mil.	10 Mil.	10 Mil.		
Operation (Time/Hour)		1200	1200	1200	1200	1200		
Magnetic Contactor	Weight (kg)		0.33	0.37	0.38	0.38	0.55	
	Appearance Dimensions (W×H×D) (mm)		43×81×83.5	53.5×81×83.5	53.5×81×83.5	53.5×81×83.5	73×95×93	
	Installation dimension (mm)							
Mechanical Interlock		MPU-11	MPU-21	MPU-21	MPU-21	MPU-11		

Charact-eristics

SP

Series

MS

Series

Other

Series

Coil

TH

Series

SD

Series

Selec-tion

Others



32T	35T	38T	40T	50T	60T
S-P32T	S-P35T	S-P38T	S-P40T	S-P50T	S-P60T
S-2XP32T	S-2xP35T	S-2XP38T	S-2xP40T	S-2xP50T	S-2xP60T
MSO-P32T	MSO-P35T	MSO-P38T	MSO-P40T	MSO-P50T	MSO-P60T
MSO-2xP32T	MSO-2xP35T	MSO-2xP38T	MSO-2xP40T	MSO-2xP50T	MSO-2xP60T
MS-P32T	MS-P35T	MS-P38T	MS-P40T	MS-P50T	MS-P60T
MS-2xP32T	MS-2xP35T	MS-2xP38T	MS-2xP40T	MS-2xP50T	MS-2xP60T
MS-P32TPB	MS-P35TPB	MS-P38TPB	MS-P40TPB	MS-P50TPB	MS-P60TPB
TH-P20ES TA	TH-P20ES TA	TH-P20ES TA	TH-P20ES TA	TH-P60ES	TH-P60ES TA
TH-P20ES TAPP	TH-P20ES TAPP	TH-P20ES TAPP	TH-P20ES TAPP	TH-P60ES PP	TH-P60ES TAPP
7.5/10/32	9/ 12.5/ 35	11/15/39	11/ 15/ 44	15/ 20/ 58	19/ 25/ 65
15/20/32	18.5/ 25/ 35	18.5/25/38	22/ 30/ 40	30/ 40/ 52	37/ 50/ 65
15/20/32	18.5/ 25/ 27	18.5/25/38	22/ 30/ 40	30/ 40/ 52	37/ 50/ 65
15/20/22	18.5/ 25/ 22	18.5/25/29	22/ 30/ 32	30/ 40/ 41	37/ 50/ 52
15/20/18	18.5/ 25/ 18	18.5/25/22	22/ 30/ 26	30/ 40/ 34	37/ 50/ 43
50	50	60	50	115	115
AC660	AC660	AC660	AC660	AC660	AC660
-	2/ 24	-	3/ 34	5/ 56	5/ 56
-	5/ 28	-	7.5/ 40	10/ 50	10/ 50
-	10/ 28	-	15/ 42	20/ 54	20/ 54
-	20/ 27	-	20/ 27	30/ 40	40/ 52
-	30/ 32	-	30/ 32	40/ 41	50/ 52
-	50	-	50	115	115
-	AC600	-	AC600	AC600	AC600
2	2	2	2	2	2
1NO 1NC	2NO 2NC	2NO 2NC	2NO 2NC	2NO 2NC	2NO 2NC
-	-	-	-	-	-
1.6	1.6	1.6	1.6	1.6	1.6
0.95	0.95	0.95	0.95	0.95	0.95
16	16	16	16	16	16
A600, Q300	A600, Q300	A600, Q300	A600, Q300	A600, Q300	A600, Q300
1.3 Mil.	1.3 Mil.	1.3 Mil.	1.3 Mil.	1.3 Mil.	1.3 Mil.
10 Mil.	10 Mil.	10 Mil.	10 Mil.	6 Mil.	6 Mil.
1200	1200	1200	1200	1200	1200
0.38	0.55	0.55	0.55	1.05	1.05
53.5x81x83.5	73x95x93	73x95x93	73x95x93	87.9x115x107	87.9x115x107

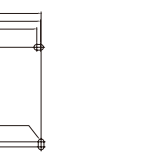
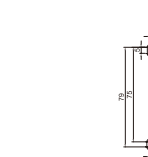
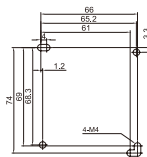
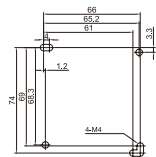
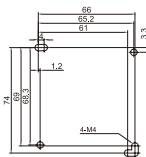
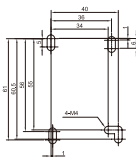

MPU-21

MPU-11

MPU-11

MPU-11

MPU-11

MPU-11

Magnetic Contactor / Starter ◆ AC control

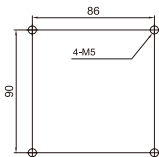
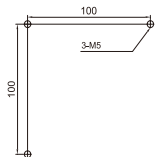
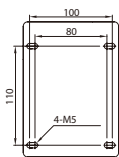

Model		80T	100T	125T	150T		
Type	Magnetic Contactor	Nonreversing	S-P80T	S-P100T	S-P125T	S-P150T	
		Reversing	S-2×P80T	S-2×P100T	S-2×P125T	S-2×P150T	
	Motor Starter	without enclosure	Nonreversing	MSO-P80T	MSO-P100T	MSO-P125T	MSO-P150T
			Reversing	MSO-2×P80T	MSO-2×P100T	MSO-2×P125T	MSO-2×P150T
		with enclosure	Nonreversing	MS-P80T	MS-P100T	MS-P125T	MS-P150T
			Reversing	MS-2×P80T	MS-2×P100T	MS-2×P125T	MS-2×P150T
		with enclosure (push button)	Nonreversing	-	-	-	-
		TOR	Standard	TH-P60ES TA	TH-P120 E(TA)	TH-P120 E(TA)	TH-P120 E(TA)
	Differential		TH-P60ES TAPP	TH-P120(TA)PP	TH-P120(TA)PP	TH-P120(TA)PP	
	Rated Capacity	IEC 60947-4-1 EN 60947-4-1 DIN VDE 0660	3 φ	240V	22/ 30/ 80	30/ 40/ 105	37/ 50/ 135
380/415V				45/ 60/ 80	60/ 80/ 105	75/ 100/ 130	90/ 125/ 160
440V				45/ 60/ 75	60/ 80/ 105	75/ 100/ 130	90/ 125/ 160
550V				45/ 60/ 60	60/ 80/ 85	75/ 100/ 105	90/ 125/ 130
660V				45/ 60/ 50	60/ 80/ 70	75/ 100/ 90	90/ 125/ 110
AC 3 (kW/HP/A)		Continuous Current (Ith) AC1 (A)	115	150	170	225	
		Rated insulation voltage (Ui) (V)	AC660	AC660	AC660	AC660	
UL 508 CSA-C22.2		1 φ	100~120V	7.5/ 80	-	-	-
			200~240V	15/ 68	-	-	-
		3 φ	200~240V	25/ 68	30/ 80	50/ 130	60/ 154
			380~480V	50/ 65	60/ 77	100/ 124	125/ 156
			550~600V	60/ 62	60/ 62	100/ 99	125/ 125
		AC3 (HP/A)	Continuous Current (Ith) AC1 (A)	115	150	170	225
Rated insulation voltage (Ui) (V)			AC600	AC600	AC600	AC600	
NEMA		3	3	3	3		
Auxiliary Contact	IEC 60947-5-1 EN 60947-5-1 GB14048.4	Contact	Standard	2NO 2NC	2NO 2NC	2NO 2NC	2NO 2NC
			Special	-	-	-	-
			220V	1.6	1.6	3.3	3.3
			380V	0.95	0.95	1.6	1.6
	AC 15	Continuous Current (Ith) AC1 (A)	16	16	16	16	
		Contact class (UL)	A600, Q300	A600, Q300	A600, Q300	A600, Q300	
Electrical Life		AC3	1.2 Mil.	1.2 Mil.	1.2 Mil.	1.2 Mil.	
Mechanical Life			6 Mil.	6 Mil.	6 Mil.	6 Mil.	
Operation (Time/Hour)			1200	1200	1200	1200	
Magnetic Contactor	Weight (kg)		1.5	2.35	2.7	2.7	
	Appearance Dimensions (W×H×D) (mm)		93×142×116	120×116×128	106×152.5×140	106×152.5×140	
	Installation dimension (mm)						
Mechanical Interlock		MPU-50	Install by manufacturer	MPU-125	MPU-125		



200T	220T	300T	400T
S-P200T	S-P220T	S-P300T	S-P400T
S-2xP200T	S-2xP220T	S-2xP300T	S-2xP400T
MSO-P200T	MSO-P220T	MSO-P300T	MSO-P400T
MSO-2xP200T	MSO-2xP220T	MSO-2xP300T	MSO-2xP400T
MS-P200T	MS-P220T	-	-
MS-2xP200T	MS-2xP220T	-	-
-	-	-	-
TH-P220T E	TH-P220T E	TH-P400T E	TH-P400T E
TH-P220TPP	TH-P220TPP	TH-P400TPP	TH-P400TPP
55/ 75/ 200	65/ 85/ 225	90/ 125/ 300	110/ 150/ 400
110/ 150/ 190	120/ 160/ 220	160/ 220/ 300	220/ 300/ 400
110/ 150/ 190	120/ 160/ 220	185/ 250/ 300	250/ 340/ 400
110/ 150/ 150	132/ 180/ 180	185/ 250/ 263	250/ 340/ 360
110/ 150/ 125	132/ 180/ 150	200/ 300/ 220	280/ 380/ 305
275	315	500	635
AC660	AC660	AC1000	AC1000
-	-	-	-
-	-	-	-
75/ 192	75/ 192	100/ 248	125/ 312
150/ 180	150/ 180	200/ 240	250/ 302
150/ 144	150/ 144	200/ 192	300/ 289
275	315	500	635
AC600	AC600	AC1000	AC1000
4	4	5	5
2NO 2NC	2NO 2NC	2NO 2NC	2NO 2NC
-	-	-	-
3.3	3.3	3.3	3.3
1.6	1.6	1.6	1.6
16	16	10	10
A600, Q300	A600, Q300	A600, Q300	A600, Q300
1.2 Mil.	1.2 Mil.	1.2 Mil.	1.2 Mil.
6 Mil.	6 Mil.	6 Mil.	6 Mil.
1200	1200	1200	1200
4.35	4.35	9.75	9.75
138x185x159.5	138x185x159.5	164x246x196.5	164x246x196.5

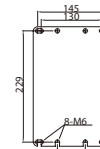
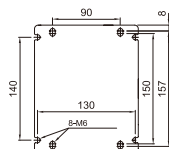

MPU-125

MPU-125

MPU-125

MPU-125

Characteristics

SP

Series

MS

Series

Other

Series

Coil

TH

Series

SD

Series

Selection

Others

MS

Magnetic Contactor / Starter ♦ AC control



Model		630T		800T		1260T	
Magnetic Contactor	Nonreversing	S-P630T		S-P800T		S-P1260T	
	Reversing	S-2XP630T		S-2XP800T		S-2XP1260T	
Type	Motor Starter	without enclosure	Nonreversing	-	-	-	
			Reversing	-	-	-	
		with enclosure	Nonreversing	-	-	-	
			Reversing	-	-	-	
	with enclosure (push button)	Nonreversing	-	-	-		
	TOR	Standard	TH-P600(E)	TH-P600(E)	-		
Differential		TH-P600PP	TH-P600PP	-			
Rated Capacity	IEC 60947-4-1 EN 60947-4-1 DIN VDE 0660	3 Ø	240V	200 / 270 / 630	250 / 340 / 800	-	
			380/415V	335 / 450 / 630	450 / 610 / 800	-	
			440V	400 / 545 / 630	450 / 610 / 800	-	
			550V	400 / 545 / 552	450 / 610 / 620	-	
			660V	450 / 610 / 450	475 / 645 / 475	-	
	AC 3 (kW/HP/A)	Continuous Current (Ith) AC1 (A)	800	1000	1260		
		Rated insulation voltage (Ui) (V)	AC1000	AC1000	AC1000		
	UL 508 CSA-C22.2	1 Ø	100~120V	-	-	-	
			200~240V	-	-	-	
		3 Ø	200~240V	-	-	-	
			380~480V	-	-	-	
			550~600V	-	-	-	
	AC3 (HP/A)	Continuous Current (Ith) AC1 (A)	-	-	-		
		Rated insulation voltage (Ui) (V)	-	-	-		
NEMA		3	3	4			
Auxiliary Contact	IEC 60947-5-1 EN 60947-5-1 GB14048.4	Contact	Standard	2NO 2NC*	2NO 2NC*	-	
			Special	-	-	-	
			220V	-	-	-	
			380V	-	-	-	
	AC 15	Continuous Current (Ith) AC1 (A)	-	-	-		
	Contact class (UL)	-	-	-			
Electrical Life		AC3	500000	500000	-		
Mechanical Life			3000000	3000000	3000000		
Operation (Time/Hour)			-	-	-		
Magnetic Contactor	Weight (kg)		16.4	18.3	18.3		
	Appearance Dimensions (W×H×D) (mm)		309×304×255	309×338×255	309×338×255		
	Installation dimension (mm)						
Mechanical Interlock			-	-	-		

*Note: S-P630T and S-P800T is equipped with AP-22N (2NO2NC) when ordered, S-P1260T can be purchase separated.

Magnetic Contactor / Starter ♦ AC control

Mini Contactor



Model		06	09		
Magnetic Contactor	Nonreversing	S-P06	S-P09		
	Reversing	S-2×P06	S-2×P09		
Type	without enclosure	Nonreversing	MSO-P06	MSO-P09	
		Reversing	-	-	
	with enclosure	Nonreversing	-	-	
		Reversing	-	-	
	with enclosure (push button)	Nonreversing	-	-	
	TOR	Standard	-	-	
Differential		TH-P09PP	TH-P09PP		
Rated Capacity	IEC 60947-4-1 EN 60947-4-1 DIN VDE 0660	3 ∅	240V	1.5/ 2/ 7.5	2.2/ 3/ 10.1
			380/415V	3/ 4/ 6.6	4/ 5.5/ 9
			440V	3/ 4/ 6.5	4/ 5.5/ 8.5
			550V	3/ 4/ 5	4/ 5.5/ 6.5
			660V	3/ 4/ 4	4/ 5.5/ 5
	AC 3 (kW/HP/A)	Continuous Current (Ith) AC1 (A)	20	20	
		Rated insulation voltage (Ui) (V)	AC690	AC690	
	UL 508 CSA-C22.2	1 ∅	100~120V	0.25/ 5.8	0.5/ 9.8
			200~240V	1/ 8	1.5/ 10
		3 ∅	200~240V	2/ 6.8	3/ 9.6
			380~480V	3/ 4.8	5/ 7.6
		550~600V	3/ 3.9	5/ 6.1	
AC3 (HP/A)	Continuous Current (Ith) AC1 (A)	20	20		
	Rated insulation voltage (Ui) (V)	AC600	AC600		
NEMA		00	00		
Auxiliary Contact	IEC 60947-5-1 EN 60947-5-1 GB14048.4	Contact	Standard	1NO	1NO
			Special	1NC	1NC
			220V	3.3	3.3
			380V	1.9	1.9
	AC 15	Continuous Current (Ith) AC1 (A)	10	10	
	Contact class (UL)	A600	A600		
Electrical Life		AC3	1.6 Mil.	1.6 Mil.	
Mechanical Life			10 Mil.	10 Mil.	
Operation (Time/Hour)			1200	1200	
Magnetic Contactor	Weight (kg)		0.15	0.15	
	Appearance Dimensions (W×H×D) (mm)		46×58×51	46×58×51	
	Installation dimension (mm)				
Mechanical Interlock			-	-	

Thermal Overload Relay



Type	09	
Standard	Contact Assembled Type	-
	Independently Installed Type	-
With phase failure protection	Contact Assembled Type	TH-P09PP
	Independently Installed Type	-
Reset Mode		Manual / Automatic
Magnetic Contactor		S-P06, S-P09.
TOR Adjustment Range (A)	Rating (A)	Range (A)
	0.13	0.1~0.16
	0.20	0.16~0.24
	0.32	0.24~0.4
	0.5	0.4~0.6
	0.8	0.6~1
	1.3	1~1.6
Auxiliary Contact	1NO	1NC
	2.0	1.6~2.4
	3.2	2.4~4
	5	4~6
Weight	7.5	6~9
	Dimensions (mm) (W×H×D)	

Coil Specification Table

♦ S-P06, S-P09						
Description	AC12V	AC24V	AC48V	AC110V	AC120V	AC220V
Coil rated specifications marking	12V 50Hz	24V 50Hz	48~50V 50Hz	100V 50Hz	110~120V 50Hz	200~220V 50Hz
	12V 60Hz	24V 60Hz	48~50V 60Hz	100~110V 60Hz	115~120V 60Hz	220V 60Hz
Description	AC230V	AC240V	AC380V	AC440V	AC480V	AC550V
Coil rated specifications marking	230V 50Hz	220~240V 50Hz	346~380V 50Hz	400V 50Hz	415~440V 50Hz	500V 50Hz
	230V 60Hz	240~260V 60Hz	380V 60Hz	400~440V 60Hz	460~480V 60Hz	500~550V 60Hz

Charact-eristics

SP

Series

MS

Series

Other

Series

Coil

TH

Series

SD

Series

Selec-tion

Others

Other | SD Series | DC control type

Type designation



SD	-	2x	P	21	220V
①		②	③	④	⑤

①	Model	SD	DC Contactor
②	Non-reversing/reversing	Blank	Non-reversing
		2x	Reversing
③	Series	P	P Series
④	Rated capacity	06、09、11、16、21	
⑤	Control circuit voltage	EX : 12V、24V、30V*、48V...110V、220V...	

*Note: control circuit voltage 30V can be customized.

Other | MDO Series | DC control type

Type designation

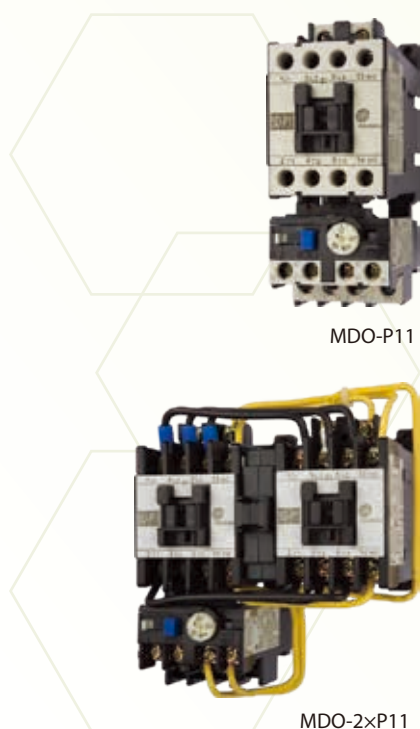

MDO	-	2x	P	21	380V /	220V	28A	E
①		②	③	④	⑤	⑥	⑦	⑧

①	Model	MDO	DC Magnetic Switch without enclosure
②	Non-reversing/reversing	Blank	Non-reversing
		2x	Reversing
③	Series	P	P Series
④	Rated capacity	11、16、21	
⑤	Main circuit voltage	EX : 110V、220V、380V、440V... (When main circuit voltage and control circuit voltage are the same, it will be blank.)	
⑥	Control circuit voltage	EX : 12V、24V、48V...110V、220V...	
⑦	TH heater rated capacity	EX : 3.3A、6.5A、9A、11A...21A...	
⑧	TH Type	Blank	Compressor Type (2 heaters)
		E	3 heaters
		PP	Differential

Magnetic Contactor / Starter ♦ DC control



Model		06	09	11	16	21		
Magnetic Contactor	Nonreversing	SD-P06	SD-P09	SD-P11	SD-P16	SD-P21		
	Reversing	SD-2xP06	SD-2xP09	SD-2xP11	SD-2xP16	SD-2xP21		
Type	without enclosure	Nonreversing	-	-	MDO-P11	MDO-P16	MDO-P21	
		Reversing	-	-	MDO-2xP11	MDO-2xP16	MDO-2xP21	
	with enclosure	Nonreversing	-	-	-	-	-	
		Reversing	-	-	-	-	-	
	with enclosure (push button)	Nonreversing	-	-	-	-		
	TOR	Standard	-	-	TH-P12	TH-P20	TH-P20	
		Differential	TH-P09PP	TH-P09PP	TH-P12ES PP	TH-P20ES PP	TH-P20ES PP	
Rated Capacity	IEC 60947-4-1 EN 60947-4-1 DIN VDE 0660	3 ø	240V	1.5 / 2 / 6	2.2 / 3 / 9	3.5 / 4.5 / 13	4.5 / 6 / 18	5.5 / 7.5 / 24
			380/440V	3 / 4 / 6	4 / 5.5 / 9	5.5 / 7.5 / 12	7.5 / 10 / 18	11 / 15 / 21
			550V	3 / 4 / 6	4 / 5.5 / 9	5.5 / 7.5 / 9	7.5 / 10 / 13	11 / 15 / 17
			660V	-	-	5.5 / 7.5 / 7	7.5 / 10 / 9	11 / 15 / 14
	AC 3 (kW/HP/A)	Continuous Current (Ith)	AC1 (A)	20	20	20	30	32
		Rated insulation voltage	(Ui)	690	690	660	660	660
	UL 508 CSA-C22.2	1 ø	110~120V	0.25 / 5.8	0.5 / 9.8	0.5 / 9.8	1 / 16	2 / 24
			220~240V	1 / 8	1.5 / 10	2 / 12	3 / 17	3 / 17
		3 ø	220~240V	2 / 6.8	3 / 9.6	3 / 9.6	5 / 15.2	7.5 / 22
			440~480V	3 / 4.8	5 / 7.6	7.5 / 11	10 / 14	15 / 21
AC3 (HP/A)		550~600V	3 / 3.9	5 / 6.1	10 / 11	10 / 11	15 / 17	
		Continuous Current (Ith)	AC1 (A)	20	20	24	30	35
Rated insulation voltage	(Ui)	600	600	600	600	600		
NEMA		0	0	0	0	1		
Auxiliary Contact	Auxiliary contact	Standard	1NO	1NO	1NO	1NO1NC	1NO1NC	
		Special	1NC	1NC	1NC	-	-	
	Control coil voltage DC (V)		24 / 36 / 48 / 110 / 220 / 240			12 / 24 / 30 / 48 / 72 / 110 / 125 / 220		
	EC 60947-5-1 EN 60947-5-1	220V	3.3	3.3	1.6	1.6	1.6	
		380V	1.9	1.9	0.95	0.95	0.95	
	Rated heating current (Ith)		(A)	10	10	16	16	16
Contact class		(UL)	A600	A600	A600	A600	A600	
Performanc	Electrical life (AC3) (10 thousand)		120	120	120	120	120	
	Mechanical life (10 thousand)		600	600	600	600	600	
Magnetic Contactor	Weight		(kg)	0.43	0.43	0.33	0.37	0.38
	Appearance Dimensions (WxHxD)		(mm)	46 x 58 x 51	46 x 58 x 51	43 x 81 x 83.5	53.5x81x83.5	53.5x81x83.5
	Installation dimension		(mm)					

Charact-eristics

SP

Series

MS

Series

Other

Series

Coil

TH

Series

SD

Series

Selec-tion

Others

MS

13

Type designation

SC	-	P	12	220V
①		②	③	④



①	Model	
	SC	Electromagnetic contactor
②	Series	
	P	P Series (Non-reversing)
③	Rated capacity	
		12、16、20、25、33、45、60、70
④	Control circuit voltage	
		EX : 110V、220V、380V、440V

● Feature:

a : applicable to rated voltage AC600V and below, with frequency at 50Hz/60Hz, and applied as a contactor for connecting and disconnecting low-voltage capacitors in parallel.

b : contactor is equipped with current limiting resistor, which can suppress surge current output from capacitors when they are initially connected, which could effectively reduce the impact of surge current to the capacitors and increase the life and reliability of capacitors.

Characteristics

SP

Series

MS

Series

Other

Series

Coil

TH

Series

SD

Series

Selection

Others

Capacitor Contactor

Type		SC-P12	SC-P16	SC-P20	SC-P25	SC-P33	SC-P45	SC-P60	SC-P70		
Rated insulation voltage (Ui) (V)		690	690	690	690	690	690	690	690		
Rated Capacity	IEC 60947-4-1 EN 60947-4-1 DIN VDE 0660 AC 3 (kW/HP/A)	AC-6b 3 ∅ (kVar/A)	200~240V	6.7/ 18	8.5/ 22	10/ 26	15/ 39	20/ 48	25/ 66	35/ 92	60/118
			400~440V	12.5/ 16	16.7/ 22	20/ 26	25/ 33	33.3/ 44	45/ 59	60/ 86	70/101
			660~690V	18/ 15	24/ 20	30/ 25	36/ 30	48/ 40	58/ 49	75/ 63	90/78
	Continuous Current (Ith) AC1 (A)		20	30	40	50	80	90	100	135	
Auxiliary Contact		2NO or 1NO 1NC	2NO 1NC	2NO 1NC	3NO 2NC	3NO 2NC	3NO 2NC	3NO 2NC	3NO 2NC		
Auxiliary Contact	IEC 60947-5-1 EN 60947-5-1	AC12 (A)	110V	6	6	6	6	6	6	6	
			220V	5	5	5	5	5	5	5	
			440V	3	3	3	3	3	3	3	
			550V	3	3	3	3	3	3	3	
	Continuous Current (Ith) (A)		16	16	16	16	16	16	16	16	
Mechanical Life / Electrical Life (AC-6b) ≤440V (10 thousand)		100 / 30	100 / 30	100 / 30	100 / 30	100 / 30	100 / 30	100 / 30	600/20		
Operation Frequency (time/ hour)		240	240	240	240	240	240	100	100		
Magnetic Contactor	Weight (kg)		0.42	0.47	0.47	0.63	1.14	1.14	1.59	2.4	
	Installation Dimensions (W×H×D) (mm)		44×108×134	54×112×134	54×112×134	74×185×144	89×185×158	89×185×158	101×195×168	120 x 180 x 169	
	Dimensions (mm)										

Capacitor Unit



Capacitor Unit	Magnetic Contactor	Maximum operating power(kvar)			Max. peak current(A)
		220~240V	400~440V	660~690V	
AP-40 A	S-P11	6.7	12.5	18	560
	S-P16	8.5	16.7	24	560
	S-P21	10	20	30	1250
AP-40 B	S-P40T	15	25	36	1900
	S-P50T	20	33.3	48	2160
	S-P60T	25	45	58	3040
	S-P80T	35	60	75	3040

Charact-eristics

SP

Series

MS

Series

Other

Series

Coil

TH

Series

SD

Series

Selec-tion

Others

Type designation

SF	-	20	C	2	M
①		②	③	④	⑤



①	Model						
	SF	Definite purposes					
②	Rated capacity						
	20, 25, 30, 35, 40						
③	Type						
	C	close type					
④	Contact structure						
	1	1 Pole					
	2	2 Pole					
	3	1 Pole + conductor contact					
⑤	Code of Coil voltage						
	Frequency	H	A	L	M	B	F
	50Hz	24V	110~120V	200V	220V	208~240V	277V
	60Hz	24V	110~120V	200V	220V	208~240V	277V

● Features:

- All contacts are AMP250 quick contacts , which saves wiring
- Compact size saving panel space.
- Standard dimensions of the installation holes, compliant with the installation dimensions of the product of the same grade made by other brands.
- Comply with Air-conditioning and Refrigeration Institute, USA ARI 780/790 standards.
- Certified by cUL and compliant with the US UL508 standards.
- Certified by CSA, compliant with Canadian C.S.A. C22.2 No.14 standards.
- Comply with IEC 60947-4-1 standards, CE marking.
- Operating voltage of coil: 85%~105% rated voltage

- Charact-eristics
- SP Series
- MS Series
- Other Series
- Coil
- TH Series
- SD Series
- Selec-tion
- Others

Definite Purpose Magnetic Contactor | SF Series

Type		20	25	30	35	40
		 C1	 C2	 C3		
Type	1 Pole	SF20C1	SF25C1	SF30C1	SF35C1	SF40C1
	2 Pole	SF20C2	SF25C2	SF30C2	SF35C2	SF40C2
	1Pole w/shunt	SF20C3	SF25C3	SF30C3	SF35C3	SF40C3
Start Current(A) (Per Pole)	AC 240V / AC 277V	120	150	180	180	180
	AC 480V	100	125	150	150	150
	AC 600V	80	100	120	120	120
Start Current(A) (Single Phase) (2 Pole)	AC 240V / AC 277V	120	150	180	210	240
	AC 480V	100	125	150	175	200
	AC 600V	80	100	120	140	160
Rated Current w/resistance load (A)		30	35	40	50	50
Full Rated Current (A)		20	25	30	35	40
Mechanical / Electrical life (10 thousand)		50/25	50/25	50/25	50/25	50/25
Operation frequency (time / hour)		360	360	360	360	360
Coil Control Voltage 50/60 Hz		24 / 110-120 / 200 / 220 / 208-240 / 277				

Note: locked rotor current is the rotor current when the motor/compressor rotor is locked/immobilized, i.e. "starting current" as it is typically named.

● Applicable scope

Applicable to the motor protective system in air-conditioning equipment, refrigerator or the control of the heater, motor, pump, fan, compressor in other industrial equipment.

● Operating environment

- Altitude below 2000m
- Ambient temperature: -40°C~65°C (dew is not allowed)
- Relative humidity: 45~85%RH

● Installation direction

The normal installation direction of SF series contactor is vertical, but is allowed to tilt 30° along the front and the rear directions; and is allowed to rotate 360° along the front direction for installation.

Charact-eristics

SP

Series

MS

Series

Other

Series

Coil

TH

Series

SD

Series

Selec-tion

Others

Magnetic Control Relays



Type		SR-P40	SR-P50	SR-P80
Auxiliary Contact		4NO 3NO 1NC 2NO 2NC	5NO 4NO 1NC 3NO 2NC 2NO 3NC	8NO 7NO 1NC 6NO 2NC 5NO 3NC 4NO 4NC
Rated Capacity IEC 60947-4-1 AC15 (A)	220V	1.6	1.6	1.6
	380V	0.95	0.95	0.95
Rated insulation current (Ui) (V)		660	660	660
Continuous Current (Ith) (A)		16	16	16
Contact Class (UL)		A600, Q300	A600, Q300	A600, Q300
Electrical Life (10 thousand)		50 and up	50 and up	50 and up
Mechanical Life (10 thousand)		500	500	500
Operation Frequency (time / hour)		500	500	500

Other | SR Series | Anti-surge interference type

Type		SR-P40SA	SR-P50SA	SR-P80SA
Contact structure		4NO 3NO 1NC 2NO 2NC	5NO 4NO 1NC 3NO 2NC 2NO 3NC	8NO 7NO 1NC 6NO 2NC 5NO 3NC 4NO 4NC
Rated capacity (A)	AC 12 (IEC)	110V	6	6
		220V	5	5
		440V	3	3
		550V	3	3
	DC 12 (IEC)	24V	5	5
		48V	3	3
		110V	0.3	0.3
		220V	0.2	0.2
Continuous Current (Ith)(A)		16	16	16
contact class (UL)		A600,Q300	A600,Q300	A600,Q300
Electrical life (10 thousand times)		50	50	50
Mechanical Life (10 thousand times)		500	500	500

Auxiliary Contact Block

◆ AP Series



Installation		2P FRONT MOUNTED TYPE						4P FRONT MOUNTED TYPE						
Type		AP-20	AP-11	AP-02	AP-20N	AP-11N	AP-02N	AP-40	AP-31	AP-22	AP-40N	AP-31N	AP-22N	AP-13N
Contact		2NO	1NO 1NC	2NC	2NO	1NO 1NC	2NC	4NO	3NO 1NC	2NO 2NC	4NO	3NO 1NC	2NO 2NC	1NO 3NC
Applicable contactor		SR-P40, SR-P50 S-P9T~ S-P80T SD-P11~ SD-P21			S-P100E, S-P100T S-P630T~ S-P1260T			SR-P40, SR-P50 S-P9T~ S-P80T SD-P11~ SD-P21			S-P100E, S-P100T S-P630T~ S-P1260T			
Rated Capacity AC 15 (A)	220V	1.6			3			1.6			3			
	380V	0.95			1.9			0.95			1.9			
Operation current	(Ith) (A)	16			10			16			10			

Auxiliary Contact Block

◆ AP Series



Installation		SIDE MOUNTED TYPE	
Type		APS-11	APL-11
Contact		1NO 1NC	1NO 1NC
Applicable contactor		SR-P40, SR-P50 S-P09T~ S-P60T SD-P11~ SD-P21	S-P125, S-P150T S-P200T, S-P220T S-P300T, S-P400T
Rated Capacity AC 15 (A)	220V	1.6	
	380V	0.95	
Operation current	(Ith) (A)	16	

Auxiliary Contact Block

◆ MAP Series

Installation		2P FRONT MOUNTED TYPE			4P FRONT MOUNTED TYPE		
Type		MAP-20	MAP-11	MAP-02	MAP-40	MAP-31	MAP-22
Contact		2NO	1NO 1NC	2NC	4NO	3NO 1NC	2NO 2NC
Applicable contactor		S-P06, S-P09.					
Rated Capacity AC 15 (A)	220V	3.3					
	380V	1.9					
Continuous Current	(Ith) (A)	10					

Timer



Model		PTR-30	PRT-30F	PTR-180	PRT-180F
Delay type		On Delay	Off Delay	On Delay	Off Delay
Adjustable time (Sec)		0~30		0~180	
Rated Capacity AC15 (A)	220V	1.6			
	380V	0.95			
Continuous current (Ith) (A)		16			
Applicable contactor		SR-P40, SR-P50, S-P9T~60T, SD-P11~21			

Charact-eristics

SP

Series

MS

Series

Other

Series

Coil

TH

Series

SD

Series

Selec-tion

Others

MS

19



Varistors: Anti-surge interference

Type	BMSACW220V	BMSACW380V
Applicable contactor	SR-P40, SR-P50, S-P9T~ S-P60T.	

Push button | PB Series

Type	PB2	PB3	
Characteristics			
SP Series			
MS Series			
Other Series	<p>External dimensions(mm)</p>		
Coil			
TH Series	WET.	72.5g	110g
SD Series			
Selection			
Others			

Separate Mounting Unit



Type	UATP12
TOR	TH-P12

Coil Characteristics

Type	S-P06 S-P09	S-P9T S-P12T	S-P11 S-P15	S-P16 S-P21 S-P25 S-P30T S-P32T	S-P35T S-P38T S-P40T	S-P50T S-P60T S-P80T	S-P100T	S-P125T S-P150T	S-P200T S-P220T	S-P300T S-P400T	S-P630T S-P800T S-P1260T			
Characteristics														
Coil type	AC	AC	AC	AC	AC	AC	AC	AC	AC/DC	AC	AC/DC	AC/DC	AC/DC	
Coil Capacity (VA)	Impulse	35	76	76	76	72	250	319	370	350	440	350	420	500~1000
	Operation	8	9	9	9	12	28	36	42	20	50	20	27	15~35
Power Consumption (W)	2.5	2.7	2.7	2.7	3	7	11	10	1.3~8	12	1.3~8	3	4~8	
Operation Vot. (Us)	On	55~70%	55~75%	55~75%	59~75%	60~75%	63~75%	65~75%	75~80%	Above 75%	75~80%	Above 75%	65~80%	Above 77%
	Off	25~50%	35~50%	35~48%	36~52%	40~57%	40~57%	40~55%	40~55%	20~62%	40~60%	20~62%	20~50%	20~60%
Close Time (ms)	Aux. OFF	8~15	6~14	6~14	6~14	6~13	6~13	18~28	9~20	15~45	10~19	20~45	22~37	-
	Aux. ON	10~18	12~20	12~20	12~25	12~20	12~20	22~32	15~24	18~45	17~25	20~45	25~40	-
	Contact ON	10~18	12~20	12~20	12~25	12~20	12~20	22~32	10~20	18~50	12~27	24~50	30~45	50~70
Open Time (ms)	Aux. OFF	9~20	13~22	13~22	13~24	10~17	10~17	50~100	9~18	30~70	10~20	40~70	40~60	-
	Aux. ON	12~23	6~17	6~17	6~17	5~12	5~12	48~98	7~15	30~70	7~18	25~70	31~51	-
	Contact ON	9~20	6~17	6~17	6~17	5~12	5~12	46~96	7~15	40~70	7~20	40~70	30~50	40~60

Coil Specification Table

◆ S-P9T~S-P25, S-P30T~P220T, SR-P40~P80, SC-P12~P60						
Description	AC12V	AC24V	AC48V	AC110V	AC120V	AC220V
Coil rated specifications marking	12V 50Hz 12V 60Hz	24V 50Hz 24V 60Hz	48~50V 50Hz 48~50V 60Hz	100V 50Hz 100~110V 60Hz	110~120V 50Hz 115~120V 60Hz	200~220V 50Hz 220V 60Hz
Description	AC230V	AC240V	AC380V	AC440V	AC480V	AC550V
Coil rated specifications marking	230V 50Hz 230V 60Hz	220~240V 50Hz 240~260V 60Hz	346~380V 50Hz 380V 60Hz	400V 50Hz 400~440V 60Hz	415~440V 50Hz 460~480V 60Hz	500V 50Hz 500~550V 60Hz

"Note: Control voltage of SR-P40 can be customized DC 12/24/30/48/72/110/125/220V"

◆ S-P300T~P400T					
Description	AC48V	AC110V	AC220V	AC380V	AC550V
Coil rated specifications marking	AC 48~50V 50/60Hz DC 48V	AC 100-127V 50/60 Hz DC 100-127V	AC 200~250V 50/60Hz DC 200~250V	AC 265~450V 50/60Hz	AC 440~575V 50/60Hz

◆ S-P630T~S-P1260T			
Description	AC110V	AC220V	AC380V
Coil rated specifications marking	AC 100~127V 50/60Hz DC 100~127V	AC 200~250V 50/60Hz DC 200~250V	AC 380~440V 50/60Hz

Charact-eristics

SP

Series

MS

Series

Other

Series

Coil

TH

Series

SD

Series

Selec-tion

Others

Thermal overload relay | TH Series

Type designation

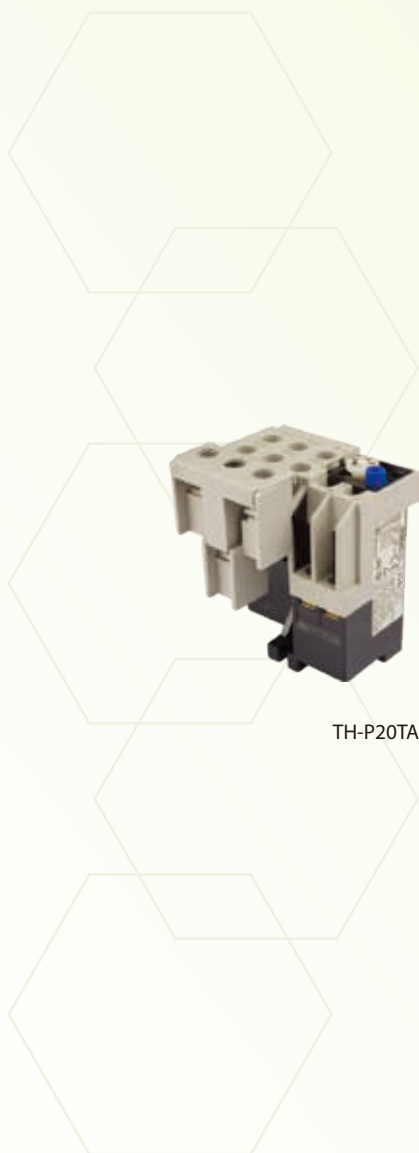

TH-P20TA

TH	-	P	20	E	TA	PP
①		②	③	④	⑤	⑥

① Model	TH	Thermal overload (overcurrent) relay
② Series	P	P series
③ Rated Capacity	12、18、20、60、120、200、400、600	
④ Type	Blank	2 heaters or Differential Type
	E	3 heaters
⑤ Contact/CT	Blank	Contact without TA
		with TA contact
	TA	20 type = 28A~40A (Other Ampere is left blank)
		60 type = 67A~80A (Other Ampere is left blank)
		120 type = 105A~160A (Other Ampere is left blank)
	CT	CT included (current transformer) ; only for 220、400、600 type
⑥ TH Type	Blank	2 heaters (standard) or 3 heaters
	PP	Differential Type

Charact-eristics

SP

Series

MS

Series

Other

Series

Coil

TH

Series

SD

Series

Selec-tion

Others

Thermal Overload Relay



Type		12	18	20					
Standard	Contactor Assembled Type	TH-P12ES	TH-P18E	TH-P20ES	TH-P20ES TA				
	#3 Independently Installed Type	Install UATP12	TH-P18ER	-	-				
With phase failure protection	Contactor Assembled Type	TH-P12ES PP	TH-P18PP	TH-P20ES PP	TH-P20ES TAPP				
	#3 Independently Installed Type	Install UATP12	TH-P18PPR	-	-				
Reset Mode		Manual / Automatic		Manual / Automatic					
Magnetic Contactor		S-P9T, S-P11, S-P12T, S-P15.		S-P16, S-P21		S-P16, S-P21, S-P25, S-P30T, S-P32T, S-P35T, S-P38T, S-P40T.		S-P25, S-P30T, S-P32T, S-P35T, S-P38T, S-P40T.	
TOR Adjustment Range (A)		Rating (A)	Range (A)	Rating	Range	Rating (A)	Range (A)	Rating (A)	Range (A)
		0.25	0.19~0.31	0.25	0.19 - 0.31	0.25	0.19~0.31	28	22~34
		0.4	0.3~0.5	0.4	0.3 - 0.5	0.4	0.3~0.5	33	28~38
		0.6	0.45~0.75	0.6	0.45 - 0.75	0.6	0.45~0.75	40	32~48
		0.9	0.7~1.1	0.9	0.7-1.1	0.9	0.7~1.1		
		1.2	0.9~1.5	1.2	0.9-1.5	1.2	0.9~1.5		
		1.7	1.3~2.1	1.7	1.3-2.1	1.7	1.3~2.1		
		2.1	1.6~2.6	2.1	1.6-2.6	2.1	1.6~2.6		
		3.3	2.5~4.1	3.3	2.5-4.1	3.3	2.5~4.1		
		4.4	3.4~5.4	4.4	3.4-5.4	4.4	3.4~5.4		
		6.5	5~8	6.5	5 - 8	6.5	5~8		
		9	7~11	9	7-11	9	7~11		
		11	9~13	11	9-13	11	9~13		
		*15	12~18	15	12-18	15	12~18		
		21	17-24	21	17~24				
Auxiliary Contact		1NO 1NC		1NO 1NC					
Weight		0.11/ 0.12		0.15		0.18/ 0.19		0.20/ 0.21	
Dimensions (mm) (WxHxD)		TH-P12ES PP: 45.5x55.5x78 TH-P12(PP)R: 47x71x86.2		53.5x55.5x78.5		TH-P20ES PP: 64.5x46.1x80		TH-P20ES TAPP: 64.5x56.2x80	

Installation Dimensions (mm)

TH-P12ES PP:
TH-P12(PP)R:

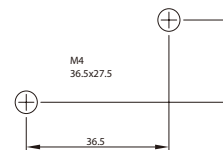
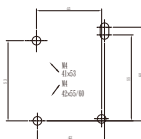
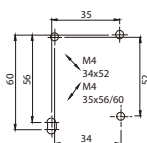

- Note.
1. The purpose of using TOR is protecting load tripping. For protecting circuit, please choose circuit breaker.
 2. When adjusting the rated current; please refer to the TOR range table above. Do not exceed its range.
 3. (E): 3 Elements
 4. *: The rating current of TH-P12 can only use up to "11A" when combined with S-P11.

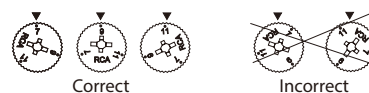

Characteristics

SP

Series

MS

Series

Other

Series

Coil

TH

Series

SD

Series

Selection

Others



Type		60				120			
Standard	Contactor Assembled Type	TH-P60ES		TH-P60ES TA		TH-P120E		TH-P120ETA	
	Independently Installed Type	-		-		-		-	
With phase failure protection	Contactor Assembled Type	TH-P60ES PP		TH-P60ES TAPP		TH-P120PP		TH-P120TAPP	
	Independently Installed Type	-		-		-		-	
Reset Mode		Manual / Automatic				Manual / Automatic			
Magnetic Contactor		S-P50T, S-P60T, S-P80T.		S-P60T, S-P80T.		S-P100T, S-P125T, S-P150T.			
TOR Adjustment Range (A)		Rating (A)	Range (A)	Rating (A)	Range (A)	Rating (A)	Range (A)	Rating (A)	Range (A)
		11	9~13	67	54~80	40	32~48	105	80~130
		15	12~18	80	60~100	54	43~65	130	100~160
		21	17~24			67	54~80	160	120~200
		28	22~34			80	60~100		
		33	28~38						
		40	32~48						
		54	43~65						
Auxiliary Contact		1NO 1NC				1NO 1NC			
Weight		0.28 / 0.30		0.34 / 0.36		0.55		0.76	
Dimensions (mm) (W×H×D)		TH-P60ES PP: 98×50.5×78		TH-P60ES TAPP: 64.5×65.5×80		TH-P120(PP): 133×54×105		TH-P120TA(PP): 133×85.5×105	

Installation Dimensions (mm)

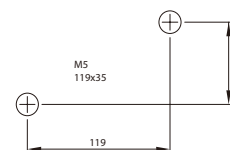
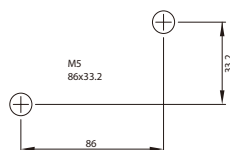

Note. 1. The purpose of using TOR is protecting load tripping. For protecting circuit, please choose circuit breaker.
 2. When adjusting the rated current; please refer to the TOR range table above. Do not exceed its range.
 3. (E): 3 Elements

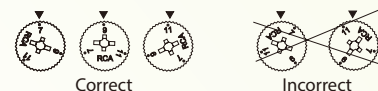

Thermal overload (overcurrent) relay | TH Series |

Tripping Characteristic

TH-P12ES tripping characteristic curve

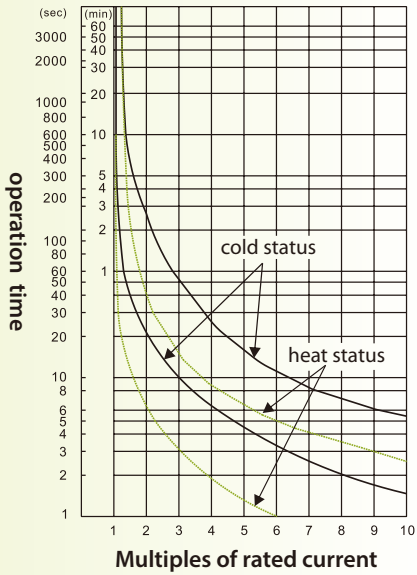

TH-P18ES – below 6.5A tripping characteristic curve

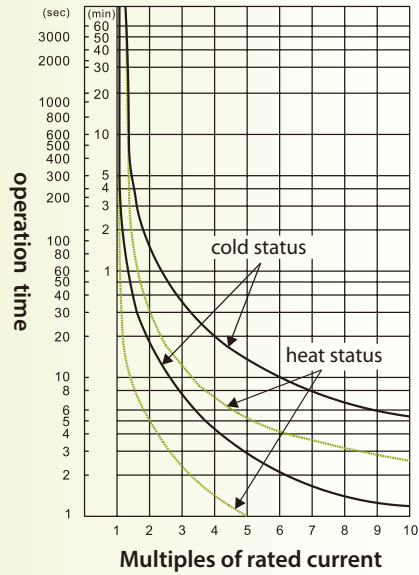

TH-P18ES – above 9A tripping characteristic curve

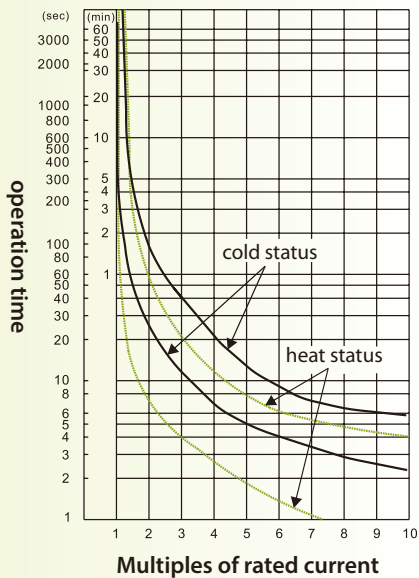

TH-P20ES – below 6.5A tripping characteristic curve

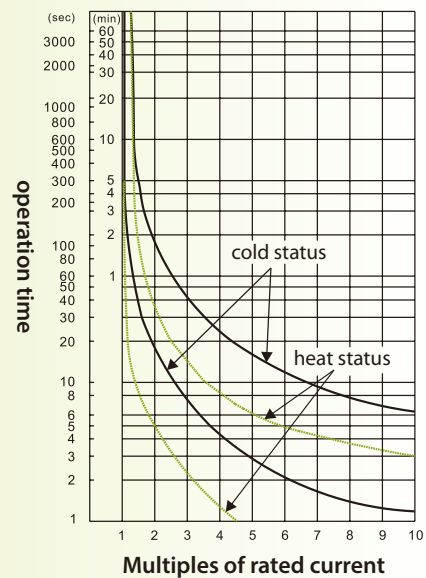

Characteristics

SP

Series

MS

Series

Other

Series

Coil

TH

Series

SD

Series

Selection

Others

Thermal overload (overcurrent) relay | TH Series |

Tripping Characteristic

TH-P20ES TA – above 9A tripping characteristic curve

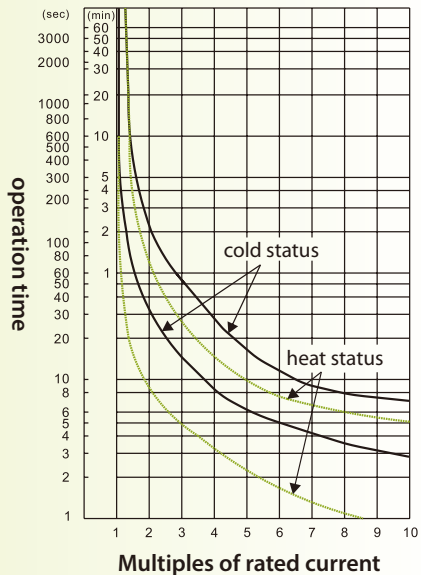

TH-P60ES TA tripping characteristic curve

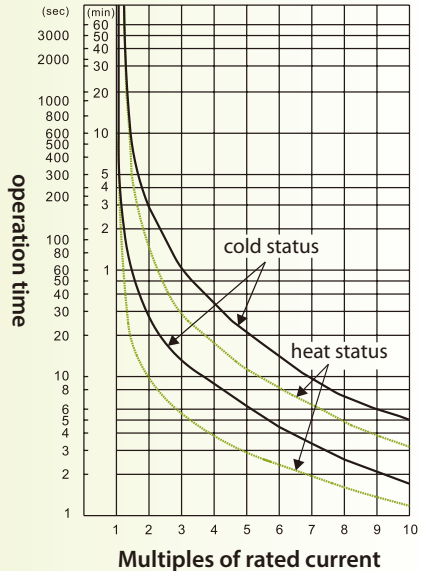

TH-P120ETA tripping characteristic curve

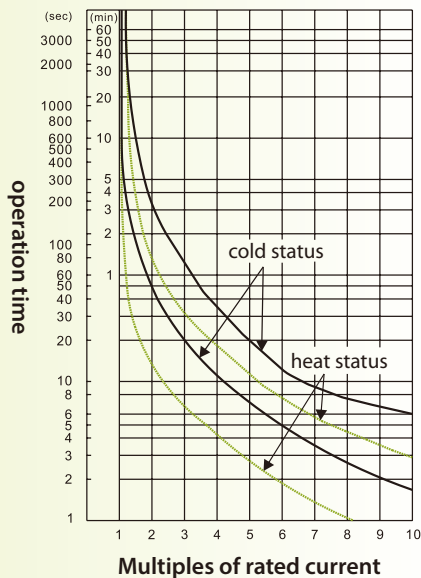

TH-P220ECT, P400ECT, TH-P220TE, P400TE 130A tripping characteristic curve

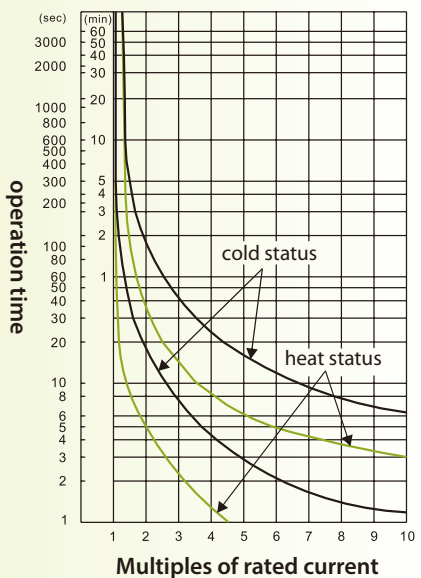

Charact-eristics

SP

Series

MS

Series

Other

Series

Coil

TH

Series

SD

Series

Selec-tion

Others

Thermal overload (overcurrent) relay | TH Series |

Tripping Characteristic

TH-P220ECT、TH-P400ECT、TH-P220TE
TH-P400TE 160A tripping characteristic curve

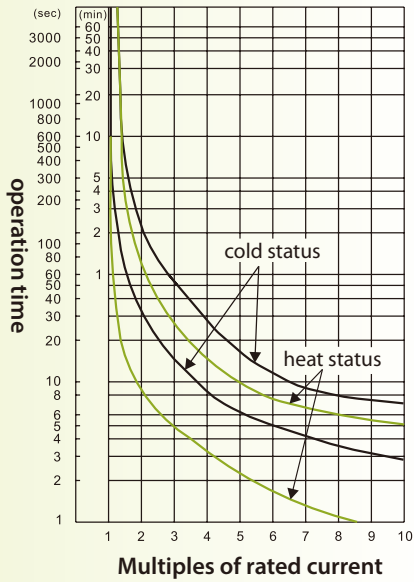

TH-P600ECT tripping characteristic curve

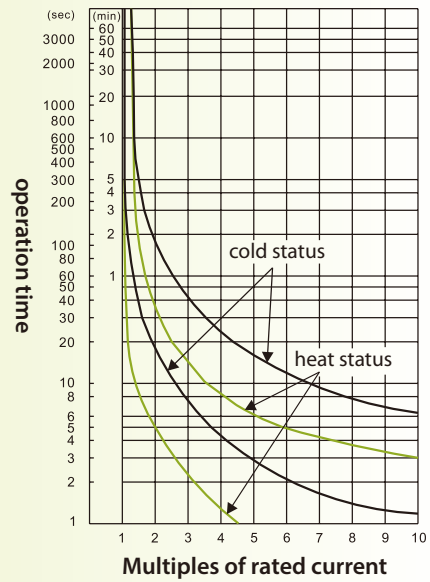

TH-P12ES PP tripping characteristic curve

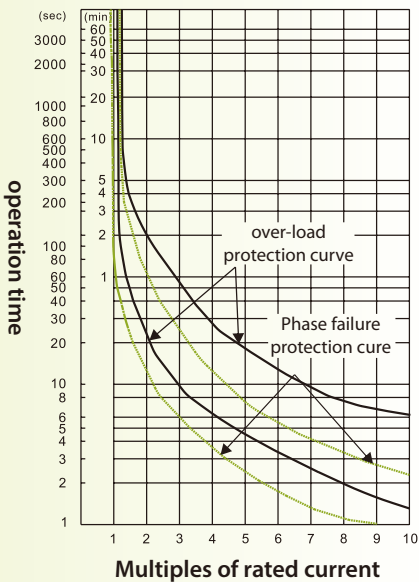

TH-P20ES TAPP tripping characteristic curve

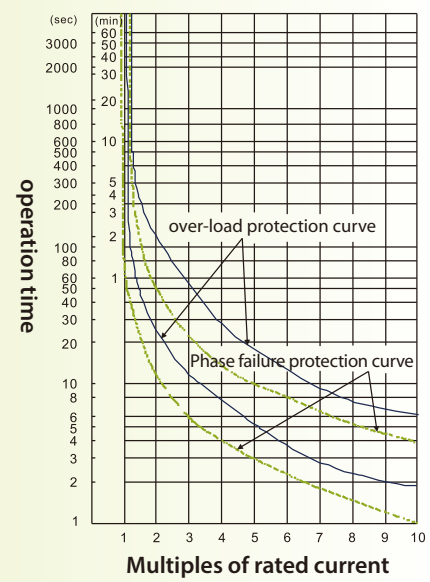

Characteristics

SP

Series

MS

Series

Other

Series

Coil

TH

Series

SD

Series

Selection

Others

Thermal overload (overcurrent) relay | TH Series |

Tripping Characteristic

TH-P12ES TAPP tripping characteristic curve

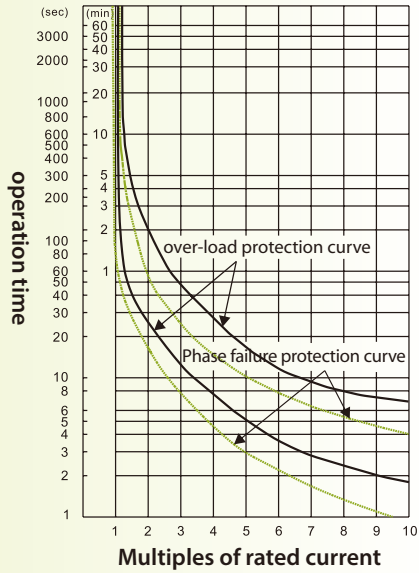

TH-P120TAPP tripping characteristic curve

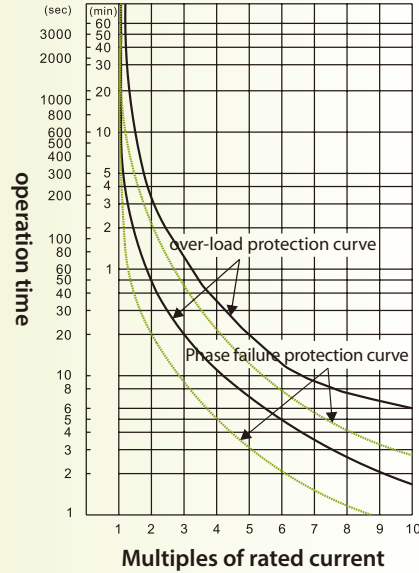

TH-P220CTPP, P400CTPP, P600CTPP, TH-P220TPP, P400TPP tripping characteristic curve

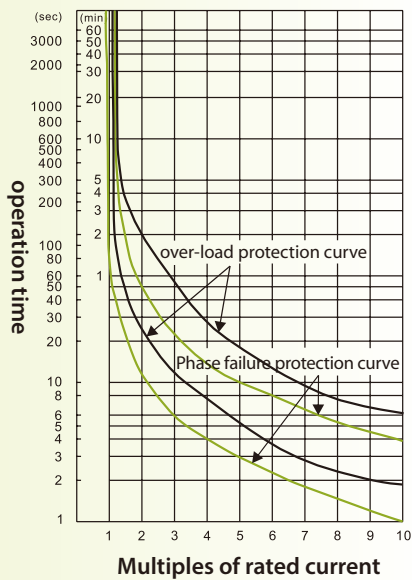

Reduced voltage Starter | SD Series (Y-D Starter)

Type designation

SD	-	O	P35	T	380V/	220V	28A	E
①		②	③	④	⑤	⑥	⑦	⑧

Characteristics

SP

Series

MS

Series

Other

Series

Coil

TH

Series

SD

Series

Selection

Others



SDO-P60



SDE-P21

①	Model	
	SD	Star-delta Starter
②	Type	
	O	without enclosure
	E	with enclosure · Push button · Indicator lamp
	A	with enclosure · Push button · Indicator lamp · Ammeter
③	Rated capacity	
		21 · 35 · 50 · 60 · 80 · 100 · 125 · 150 · 200 · 220
④	Contact / CT	
	Blank	CT not included
	T	CT included
⑤	Main circuit voltage	
		EX : 110V · 220V · 380V · 440V... When main circuit voltage and control circuit voltage are the same, it will be blank.)
⑥	Control circuit voltage	
		EX : 110V · 220V · 380V · 440V...
⑦	TH heater rated capacity	
		EX : 40A · 54A...350A...
⑧	TH Type	
	Blank	Standard (2 heaters)
	E	3 heaters
	PP	Differential

• Structure, principle

When starting by λ - starting method, starting current and torque of motor will be reduced to 1/3 of those of direct starting; the purpose is to suppress starting current, but somehow it also suppresses torque at the same.

Comparison table between direct starting and λ - Δ starting (the values in the table are all shown in %)

Starting method	When starting			In operation	
	Linear current (starting current)	Torque	Linear voltage (power voltage)	Linear current (loading current)	Phase current
Direct starting	600	150	100	100	$100 \times 1/\sqrt{3}=58$
λ - Δ starting	$600 \times 1/3=200$	$150 \times 1/3=50$	100	100	$100 \times 1/\sqrt{3}=58$

• Operating circumstance

(1) Unloaded starting circumstance.

- e.g.:
- (1-1) Starting the driving shaft of machine tool.
 - (1-2) Typical starting of woodworking machinery.
 - (1-3) Starting of grinding, drilling machines etc.
 - (1-4) Motor with clutch.

(2) Light loading circumstance.

- e.g.:
- (2-1) Small-size belt conveyer.
 - (2-2) Light loading air compressor or water pump.
 - (2-3) Stamping press etc.

(3) Equipment that needs to limit starting current.

(4) Equipment that needs to reduce starting impact.

• Notes

- (1) When speed of the motor exceeds 80% of rated value, it is the optimal time to perform λ - Δ switching.
- (2) Starting time of λ can be defined according to motor capacity (\sqrt{kW}). Use the equation $t = 4 + 2$ to derive the time required (second)
- (3) When starting by λ - Δ , ensure the power supply capacity is sufficient to prevent voltage drop in power supply during transition from λ starting to operation, which could cause the contactor to break or burn out.

Remarks:

1. Three-phase induction motor can be started by the following methods:
 - (1) Full voltage direct starting.
 - (2) Reduced voltage starting.
 - (2-1) λ - Δ starting.
 - (2-2) Reactor starting.
 - (2-3) Self-coupled transformer starting.
 - (2-4) Primary resistor starting.
2. If the motor is not limited by its starting method, direct starting can be applied for all large or small-size models. If all motors are started by direct starting, the stability of system power supply will definitely be impacted. When starting, all the appliances connected to the same loop circuitry will be influenced by voltage drop. Lamps will flash and the motor will trip, due to overload of increased current resulting from low voltage. Therefore, national standards or power company internal regulations always define the circumstances that require reduced voltage starting.

Charact-eristics

SP

Series

MS

Series

Other

Series

Coil

TH

Series

SD

Series

Selec-tion

Others

Reduced voltage starter | SD Series (Y-D Starter)

Model		21		35		50		60		80		100		125		150		220	
Type	Open	SDO-P21		SDO-P35		SDO-P50		SDO-P60		SDO-P80		SDO-P100		SDO-P125		SDO-P150		SDO-P220	
		SDO-P21T		SDO-P35T		SDO-P50T		SDO-P60T		SDO-P80T		SDO-P100T		SDO-P125T		SDO-P150T		SDO-P220T	
	Enclosure	SDE-P21		SDE-P35		SDE-P50		SDE-P60		SDE-P80		SDE-P100		SDE-P125		SDE-P150		SDE-P220	
		SDA-P21		SDA-P35		SDA-P50		SDA-P60		SDA-P80		SDA-P100		SDA-P125		SDA-P150		SDA-P220	
Rated capacity	Rated voltage	kW	HP	kW	HP	kW	HP	kW	HP	kW	HP	kW	HP	kW	HP	kW	HP	kW	HP
	200~220V	11	15	19	25	22	30	30	40	37	50	45	60	55	75	75	100	110	150
	380~440V	19	25	30	40	45	60	55	75	75	100	90	125	110	150	132	180	200	260
AC contactor	MCM	S-P21		S-P35T		S-P50T		S-P60T		S-P80T		S-P100T		S-P125T		S-P150T		S-P220T	
	MCD	S-P21		S-P35T		S-P50T		S-P60T		S-P80T		S-P100T		S-P125T		S-P150T		S-P220T	
	MCS	S-P11		S-P16		S-P21		S-P21		S-P35C		S-P35T		S-P50T		S-P50T		S-P60T	
TOR	TH-P20		TH-P60		TH-P60		TH-P120		TH-P120		TH-P120		TH-P220T		TH-P220T		TH-P400T		
	TH-P20TA		TH-P60TA		TH-P60TA		TH-P120TA		TH-P120TA		TH-P120TA		TH-P220T		TH-P400T		TH-P400T		
Wire (mm ²)	Line	2.5~16		2.5~25		2.5~35		2.5~50		10~70		10~95		35~150		35~150		35~240	
	Load	2.5~10		2.5~16		2.5~25		2.5~35		4~50		4~70		10~95		10~90		16~150	
	Control circuit	1~2.5		1~2.5		1~2.5		1~2.5		1~2.5		1~2.5		1~2.5		1~2.5		1~2.5	

- Note: 1. SDE-P21~P220 is with enclosure, push button, indicator light and door lock.
 2. SDA-P21~P220 is with enclosure, push button, indicator light, door lock, and current meter.
 3. SDO-P21~P220 is attached with CT as current meter.



SDA-P50



SDA-P50

Wiring

Connection with Breaker

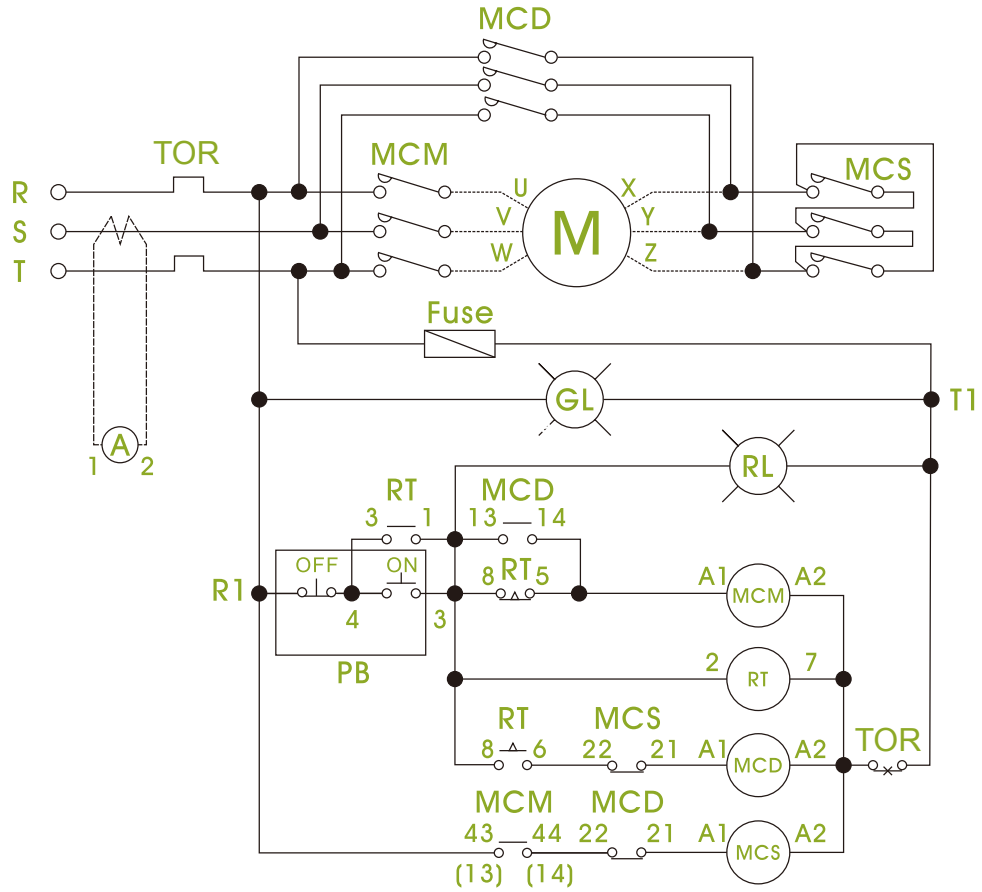

Symbol descriptions

MC	Magnetic contactor	GL	Indicator light (green)	A	Ammeter
TOR	Thermal overload (overcurrent) relay	RL	Indicator light (red)	Fuse	Fuse
RT	Time limited relay	CT	Current transformer	PB	Push button

1. The numbers in the parentheses are applicable to Model P80~P220 type.
2. Setting time for RT (Timer): $t = 4 + 2\sqrt{kW}$ (± 1 second)

Selection Table ◆ λ-Δ Starter

Heater selection table (A)	Motor output kW (HP)				TH selection of λ-Δ Starter																	
	A		B		21		35		50		60		80		100		125		150		220	
	200~220V		380~440V		A	B	A	B	A	B	A	B	A	B	A	B	A	B	A	B	A	B
6.5	1.5	(2)	3	(4)	TH-P20	TH-P20																
9	1.9	(2 1/2)	3.7	(5)																		
9	2.2	(3)	4.5	(6)																		
11	3	(4)	5.5	(7 1/2)																		
15	3.7	(5)	7.5	(10)																		
15	4.5	(6)	10	(13)																		
21	5.5	(7 1/2)	11	(15)	TH-P20TA	TH-P20TA																
28	6.5	(8)	14	(19)																		
28	7.5	(10)	15	(20)	TH-P60	TH-P60	TH-P60	TH-P60	TH-P60													
33	9	(12 1/2)	19	(25)																		
40	11	(15)	22	(30)	TH-P60TA	TH-P60TA																
40	14	(19)	26	(35)																		
54	15	(20)	30	(40)	TH-P120	TH-P120	TH-P120	TH-P120	TH-P120	TH-P120	TH-P120	TH-P120	TH-P120	TH-P120	TH-P120	TH-P120	TH-P120	TH-P120	TH-P120	TH-P120	TH-P120	
67	19	(25)	37	(50)																		
80	22	(30)	45	(60)	TH-P220T	TH-P220T	TH-P220T	TH-P220T	TH-P220T	TH-P220T	TH-P220T	TH-P220T	TH-P220T	TH-P220T	TH-P220T	TH-P220T	TH-P220T	TH-P220T	TH-P220T	TH-P220T	TH-P220T	
80	25	(34)	50	(67)																		
105	30	(40)	55	(75)	TH-P400T	TH-P400T	TH-P400T	TH-P400T	TH-P400T	TH-P400T	TH-P400T	TH-P400T	TH-P400T	TH-P400T	TH-P400T	TH-P400T	TH-P400T	TH-P400T	TH-P400T	TH-P400T	TH-P400T	
130	37	(50)	75	(100)																		
160	45	(60)	90	(125)	TH-P400T	TH-P400T	TH-P400T	TH-P400T	TH-P400T	TH-P400T	TH-P400T	TH-P400T	TH-P400T	TH-P400T	TH-P400T	TH-P400T	TH-P400T	TH-P400T	TH-P400T	TH-P400T	TH-P400T	
200	55	(75)	110	(150)																		
200	65	(85)	132	(200)	TH-P400T	TH-P400T	TH-P400T	TH-P400T	TH-P400T	TH-P400T	TH-P400T	TH-P400T	TH-P400T	TH-P400T	TH-P400T	TH-P400T	TH-P400T	TH-P400T	TH-P400T	TH-P400T	TH-P400T	
260	75	(100)	150	(200)																		
350	110	(150)	200	(260)																		

Selection Table ♦ Direct On-Line Starter

Motor rated capacity kW (HP)		3 ∅ 200V~220V		Selection of the contactor			
		Heating element rating (A)					
0.016	(1/47)	0.13A	0.1~0.16A	S-P06	S-P09		
0.025	(1/30)	0.2A	0.16~0.24A				
0.04	(1/19)	0.32A	0.24~0.4A				
0.09	(1/8)	0.5A	0.4~0.6A				
0.12	(1/6)	0.8A	0.6~1.0A				
0.25	(1/3)	1.3A	1.0~1.6A				
0.37	(1/2)	2.0A	1.6~2.4A				
0.75	(1)	3.2A	2.4~4.0A				
1.1	(1 1/2)	5A	4.0~6.0A	S-P06	S-P09		
1.5	(2)	7.5A	6.0~9.0A				
0.03	(1/25)	0.25A	0.19~0.31A			S-P06	S-P09
0.05	(1/15)	0.4A	0.3~0.5A				
0.1	(1/8)	0.6A	0.45~0.75A				
0.15	(1/5)	0.9A	0.7~1.1A				
0.2	(1/4)	1.2A	0.9~1.5A				
0.3	(2/5)	1.7A	1.3~2.1A				
0.4	(1/2)	2.1A	1.6~2.6A				
0.75	(1)	3.3A	2.5~4.1A				
1.1	(1 1/2)	4.4A	3.4~5.4A				
1.5	(2)	6.5A	5~8A	S-P06	S-P09		
2.2	(3)	9A	7~11A				
3	(4)	11A	9~13A				
3.7	(5)	15A	12~18A				
5.5	(7 1/2)	21A	17~24A				
6.5	(8 1/2)	28A	22~34A				
7.5	(10)	33A	28~38A				
9	(12 1/2)	40A	32~48A				
11	(15)	54A	43~65A				
15	(20)	67A	54~80A				
19	(25)	80A	60~100A	S-P06	S-P09		
22	(30)	105A	80~130A				
25	(35)	130A	100~160A				
30	(40)	160A	120~200A				
37	(50)	200A	150~250A				
45	(60)	260A	200~320A				
55	(75)	350A	260~440A				
65	(85)	500A	400~600A				
75	(100)						
90	(125)						
110	(150)						
132	(180)						
160	(220)						

Charact-eristics

SP

Series

MS

Series

Other

Series

Coil

TH

Series

SD

Series

Selec-tion

Others

Selection Table ♦ Direct On-Line Starter

Motor rated capacity kW (HP)		3 φ 380V~440V		Selection of the contactor																		
		Heating element rating (A)																				
0.025	(1/30)	0.13A	0.1~0.16A	S-P06	S-P09																	
0.04	(1/19)	0.2A	0.16~0.24A																			
0.09	(1/8)	0.32A	0.24~0.4A																			
0.18	(1/4)	0.5A	0.4~0.6A																			
0.25	(1/3)	0.8A	0.6~1.0A																			
0.37	(1/2)	1.3A	1.0~1.6A																			
0.55	(3/4)	2.0A	1.6~2.4A																			
0.75	(1)																					
1.1	(1 1/2)	3.2A	2.4~4.0A																			
1.5	(2)	5A	4.0~6.0A																			
2.2	(3)																					
3	(4)	7.5A	6.0~9.0A																			
0.05	(1/15)	0.25A	0.19~0.31A	S-P07, S-P11, S-P12T	S-P15, S-P16																	
0.1	(1/8)	0.4A	0.3~0.5A																			
0.2	(1/4)	0.6A	0.45~0.75A																			
0.3	(2/5)	0.9A	0.7~1.1A																			
0.4	(1/2)	1.2A	0.9~1.5A																			
0.75	(1)	1.7A	1.3~2.1A																			
1.1	(1 1/2)	2.1A	1.6~2.6A																			
1.5	(2)	3.3A	2.5~4.1A																			
2.2	(3)	4.4A	3.4~5.4A																			
3	(4)	6.5A	5~8A																			
3.7	(5)	9A	7~11A																			
4	(5 1/2)																					
4.5	(6)	11A	9~13A																			
5.5	(7 1/2)																					
7.5	(10)	15A	12~18A																			
11	(15)	21A	17~24A																			
12	(16)																					
15	(20)	28A	22~34A																			
19	(25)	33A	28~38A																			
22	(30)	40A	32~48A																			
25	(35)																					
30	(40)	54A	43~65A																			
37	(50)	67A	54~80A																			
45	(60)																					
50	(70)	80A	60~100A																			
60	(80)	105A	80~130A																			
75	(100)	130A	100~160A																			
90	(125)	160A	120~200A																			
110	(150)	200A	150~250A																			
132	(180)																					
150	(200)	260A	200~320A																			
160	(220)	350A	260~440A																			
220	(330)																					
250	(350)	500A	400~600A																			
315	(420)																					

- Characteristics
- SP Series
- MS Series
- Other Series
- Coil
- TH Series
- SD Series
- Selection
- Others

Selection Table ♦ **Magnetic contactor selection** | **Capacitor use**

Model	3 Phase Rated Capacity kVAR(A)			
	200~220V	400~440V	500V	600V
S-P9T,S-P11,S-P12T	3(8.5)	4(6)	—	—
S-P21	4.5(14)	9(13)	—	—
S-P30T,S-P32T S-P35T,S-P38T	6(18)	12(18)	—	—
S-P40T	8.5(25)	15(23)	—	—
S-P50T	12(35)	20(30)	—	—
S-P60T	13(40)	24(35)	25(30)	25(25)
S-P80T	15(50)	25(40)	30(35)	30(30)
S-P100T	22(65)	40(60)	45(50)	45(45)
S-P125T	24(72)	46(67)	50(55)	50(50)
S-P150T	25(80)	51(75)	60(70)	60(60)
S-P220T	50(150)	96(140)	110(130)	110(110)
S-P300	65(200)	120(180)	130(150)	130(130)
S-P400	85(250)	170(250)	200(230)	200(200)
S-C600	170(500)	350(500)	350(400)	400(400)

Model	Single Rated Capacity kVAR(A)			
	Single Phase		3 Phase in Series	
	200~220V	400~440V	500V	600V
S-P9T,S-P11,S-P12T	1.7(8.5)	2.4(6)	—	—
S-P21	2.8(14)	5(13)	—	—
S-P30T,S-P32T S-P35T,S-P38T	3.6(18)	7(18)	—	—
S-P40T	5(25)	9(23)	—	—
S-P50T	7(35)	12(30)	—	—
S-P60T	8(40)	14(35)	20(40)	25(40)
S-P80T	10(50)	15(40)	25(50)	30(50)
S-P100T	13(65)	25(60)	30(60)	35(60)
S-P125T	14(72)	27(67)	33(70)	37(70)
S-P150T	15(80)	30(75)	35(80)	40(80)
S-P220T	30(150)	55(140)	75(150)	90(150)
S-P300	40(200)	72(180)	90(180)	100(180)
S-P400	50(250)	100(250)	120(250)	140(250)
S-C600	100(500)	200(500)	250(500)	300(500)

Note:
 Single phase: $kVAR = 6.3 \times 10^{-9} \times (Hz) \times (\mu F) \times (V)^2$
 3 phase: $\sqrt{3}$ x single phase kVAR

Installation notes

• Operating environment

- Altitude below 3000m
- Ambient temperature: $-30^{\circ}\text{C}\sim+70^{\circ}\text{C}$ (dew is not allowed)
- Relative humidity: Relative humidity could not exceed 50% when the surrounding temperature is $+40^{\circ}\text{C}$. For lower temperature, the relative humidity can be higher. The average maximum relative humidity for the month with the highest humidity is 90%, and the average lowest temperature of that month is $+25^{\circ}\text{C}$. Please consider the possibility of frosting on the surface of the product due to temperature change.
- Withstand vibration 10Hz~55Hz 2G
- Withstand impact 5G
- Storage temperature: $-50^{\circ}\text{C}\sim+85^{\circ}\text{C}$ (dew is not allowed)
- Please do not install in a place that contains dust, moisture, salt, oil stains, or corrosive or flammable gases.
- After switch installed, please add temporary protection to avoid harmful substances like dust or moisture etc coming into contact with it, if the switch is not to be used for a long period of time.
- Coil operating voltage should be applied within 85~110% of rated voltage. If higher than 110%, the coil life will be reduced, or the coil could burn out if lower than 85%.

• Installation direction

The regular installation direction of the contactor is vertical, but is allowed 20° tilt along all directions. Refer to the figure below.

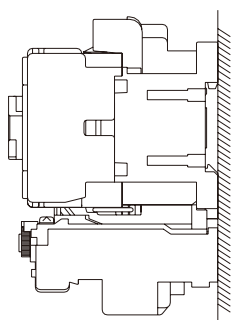

Regular installation 

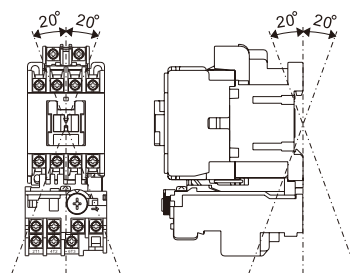

Tilt installation 

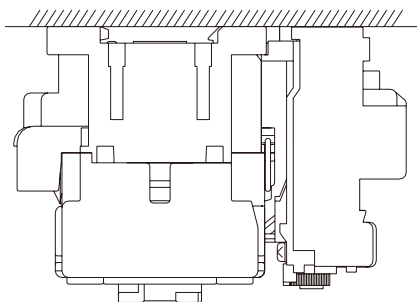

Downward installation **X**

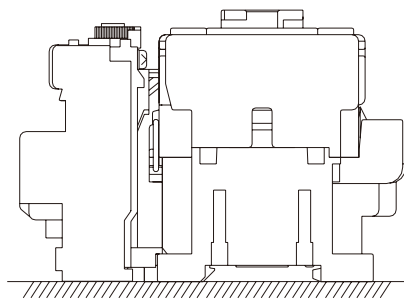

Upward installation **X**

Charact-eristics

SP

Series

MS

Series

Other

Series

Coil

TH

Series

SD

Series

Selec-tion

Others

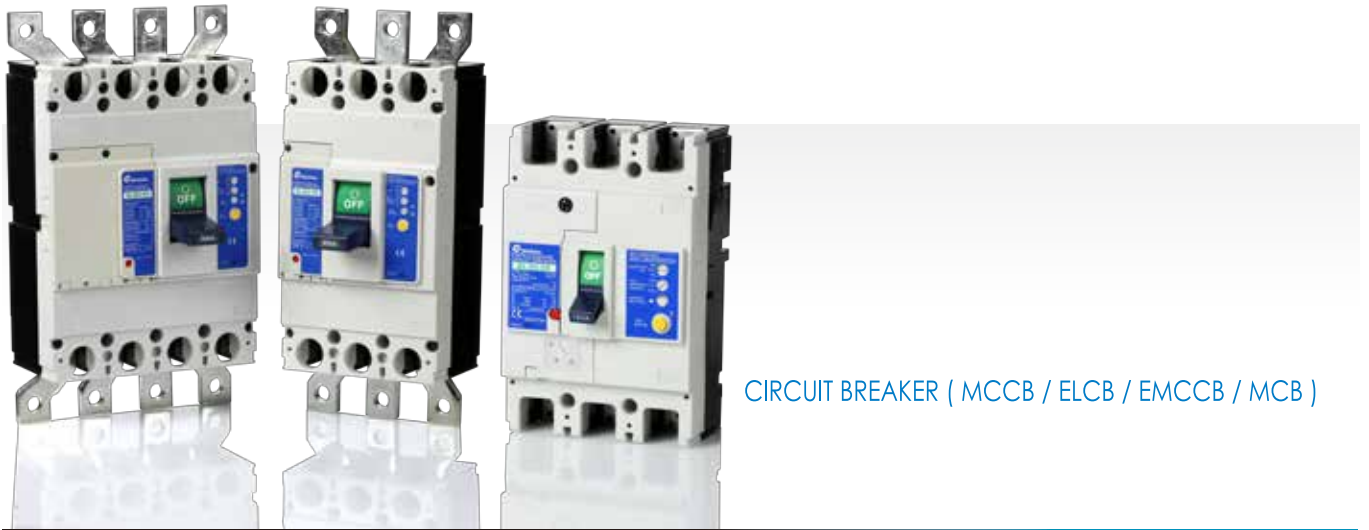

CIRCUIT BREAKER (MCCB / ELCB / EMCCB / MCB)

Breaker & Switchgear System



AIR CIRCUIT BREAKER

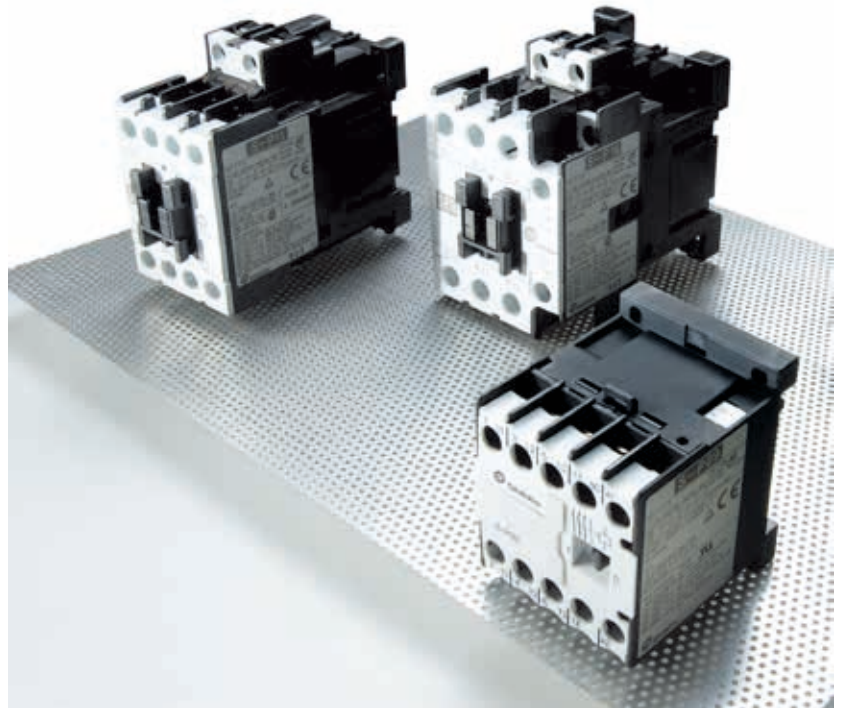

MAGNETIC CONTACTOR / SWITCH (CONTACTOR / MS / MMS)



AUTOMATIC TRANSFER SWITCHES



SURGE PROTECTIVE DEVICE



SMART METER



INVERTER



LOW VOLTAGE POWER CAPACITORS

SHIHLIN ELECTRIC & ENGINEERING

MOTOR CONTROL (CONTACTOR/ MS/ MMS), CIRCUIT BREAKER (MCCB/ ELCB/ EMCCB/ MCB), AIR CIRCUIT BREAKER, AUTOMATIC TRANSFER SWITCHES (Panel Board Type/ Residential Unit Use), SURGE PROTECTIVE DEVICE, LOW VOLTAGE POWER CAPACITORS, SMART METER, INVERTER

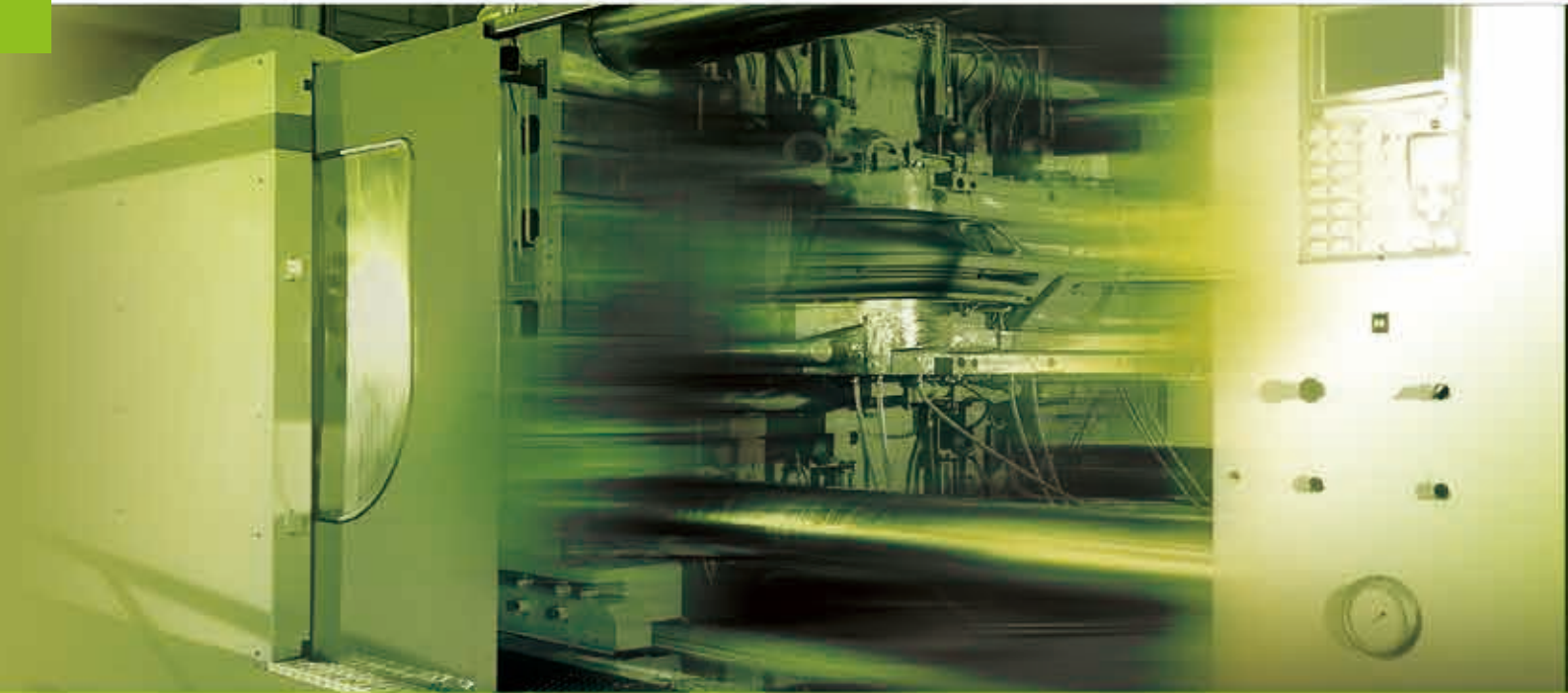

Breaker & switchgears overseas sales dept.

3F, No.9, Sec. 1, Chang-an E. Rd., Zhongshan Dist., Taipei City 10441, Taiwan

T. +886-2-2541-9822 F. +886-2-2581-2665

e-mail. b.export@seec.com.tw

<http://circuit-breaker.seec.com.tw>

Headquarters

16F, No.88, Sec. 6, Zhongshan N. Rd., Shilin Dist., Taipei City 11155, Taiwan

T. +886-2-2834-2662 F. +886-2-2836-6187

<http://www.seec.com.tw>

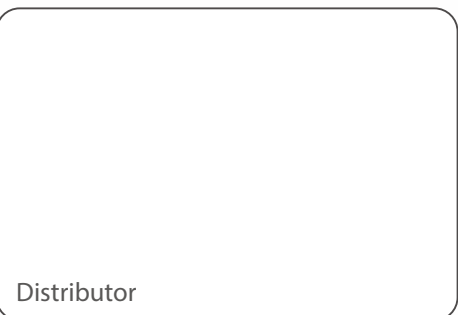

Distributor

B220908E.MS-P-OB