

## Preface

We appreciate very much for your purchasing of Shihlin servo products. This manual will be a helpful instruction to install, wire, inspect, and operate your Shihlin servo drive and motor. Before using the servo drive and motor, please read this user manual to prevent from electric shock, fire, and injury.

In this manual, the safety instruction levels are classified into "DANGER" and "CAUTION".



It indicates that incorrect operation may cause hazardous conditions, resulting in death or injury.



It indicates that incorrect operation may cause hazards, resulting in injury to person or damage to the product.

Note that the CAUTION level may lead to a serious consequence by cases. Be sure to follow the instructions of both levels to keep personnel safety well.

What must not be done and what must be done are indicated by the following marks:

 : It indicates what must not be done.

 : It indicates what must be done.

In this manual, instructions at a lower level than the above, instructions for other functions, and so on are classified into "NOTE".

After reading this user manual, always keep it accessible to the operator.

1. To prevent electric shock, please confirm the following:

 **DANGER**

- Operate the power switches with dry hand to prevent an electric shock.
- Before wiring or inspection, switch power off and wait for more than 10 minutes. Then, confirm if the power indicator is off or the voltage is safe with voltage meter. Otherwise, you may get an electric shock.
- Connect the servo drive and motor to ground.
- Do not attempt to wire the servo drive and motor until they have been installed. Otherwise, you may get an electric shock.
- The cables should not be damaged, stressed, loaded, or pinched. Otherwise, you may get an electric shock.

2. To prevent fire, note the following:

 **CAUTION**

- Install the servo drive, motor and regenerative brake resistor in a clean and dry location free from corrosive and inflammable gases or liquids. Otherwise a fire may be caused.
- Don't try to operate the servo drive or motor which has become faulty. Otherwise, a large current flow may cause a fire.
- Do not connect a commercial power supply to the U, V, W terminals of drive. Otherwise a fire may be caused and the servo drive will be damaged.
- When an external regenerative brake resistor is used, check the specification recommended. Otherwise, a regenerative brake transistor fault or the like may overheat the regenerative brake resistor, causing a fire.

3. To prevent injury, note the following:

 **CAUTION**

- The proper voltage specified in this manual should be applied to each terminal, Otherwise, a burst, damage, etc. may occur.
- Ensure that polarity (+, -) is correct. Otherwise, a burst, damage, etc. may occur.
- Ensure that all screws, connectors and wire terminations are fixed on the power supply, servo drive and motor to prevent from a burst, damage, or personal injury.
- Don't touch either the drive heat sink or the motor during operation because they may become hot and cause personnel burnt.
- Don't approach or touch any rotating parts (e.g. shaft) to prevent from serious injury.

#### 4. Other instructions

The following instructions should also be fully noted. Improper operation may cause a damage, fault, injury or electric shock, etc.

##### (1) Delivering and installation

### CAUTION

- Delivery the products correctly according to their weights.
- It is not allowed to stack the products in excess of the specified layers.
- Do not carry the motor by the cables, shaft or encoder.
- Do not hold the front cover to transport the drive. Otherwise, it may be dropped.
- The servo drive and motor must be installed in the specified direction.
- Inside control box, preserve enough space between the servo drive and other equipment.
- Provide adequate protection to prevent screws and other conductive matter, oil and other combustible matter from entering the servo drive.
- Do not drop or strike servo drive or servo motor. Keep from all impact loads.
- Use the servo drive and servo motor under the specified environmental conditions.
- Firmly attach the servo motor. Otherwise, it may come off during operation.
- For safety of personnel, always cover the rotating and moving parts.
- Never impact the servo motor or shaft, especially when coupling the servo motor to the machine. The encoder may become faulty.
- Do not subject the servo motor shaft to more than the permissible load. Otherwise, the shaft may be broken.
- When the equipment has been stored for an long period time, consult Shihlin.

##### (2) Wiring

### CAUTION

- In order to prevent from fire or other accidents, please use the cable specified in this user manual to wire the servo equipment.
- Wire the servo drive correctly and firmly. Otherwise, the motor will run improperly.
- Do not install a power capacitor, surge absorber or noise filter between the servo motor and servo drive.
- Do not connect AC power directly to the servo motor. Otherwise, it results in damage of servo motor.
- The surge absorbing diode installed on the DC output signal relay must be wired in the specified direction. Otherwise, the emergency stop and other protective circuits may not operate.

### (3) Trial run

#### CAUTION

- The initial trial run for servo motor should be operated under idle conditions (separate the motor from its couplings and belts).
- Before trial run, check if the parameters are set properly. Otherwise it will cause some unexpected operation.
- The parameter settings must not be changed excessively. To adjust the parameters setting gradually to meet your demand operation.
- Ensure to perform trial run before your normal operation to prevent unexpected accident.

### (4) Duty operation

#### CAUTION

- Set an external emergency stop circuit. It could stop operation immediately as unexpected accidents occurred.
- Before resetting an alarm, make sure that the run signal is off to prevent a sudden restart.
- Use a noise filter to minimize the influence of electromagnetic interference, which may be caused by electronic equipment used near the servo drive.
- Do not mismatch the servo drive and motor in capacity.
- The electromagnetic brake on the servo motor is designed to hold the motor shaft and should not be used for ordinary braking.
- For heavy duty case (e.g. where a huge load inertia or short acceleration/deceleration time setting), the external regenerated brake resistor is necessary.

### (5) Maintenance and Inspection

#### CAUTION

- Ensure that the power indicator is off before maintenance or inspection performed.
- Only personnel who have been trained should conduct maintenance and inspection.
- Do not try to disassemble the servo drive or motor which any fault occurred.
- Do not connect or disconnect the servo drive with motor while power is still applied.
- As power is still applied, not to touch any internal or exposed parts of servo drive and servo motor to prevent electrical shock.
- Some parts inside the servo drive are consumable and should be replaced periodically. For parts replacement, please consult Shihlin.

**NOTE** : This manual may be revised without prior notice. Please consult our agent or download the most updated version at <http://www.seec.com.tw/en/>.



<b>1. Product descriptions</b>	<b>1</b>
1.1 Summary	1
1.2 Drive model designation	1
1.3 Motor model designation	2
1.4 Drive rating plate	3
1.5 Motor rating plate	4
1.6 Function block diagram	5
1.7 Combinations of Servo Drive and Servo Motor	6
1.8 Servo control mode	6
1.9 Drive appearance and panel descriptions (1kW or less)	7
1.10 Drive appearance and panel descriptions (1.5kW or greater)	8
1.11 Wires with peripheral equipment	9
<b>2. Installation</b>	<b>10</b>
2.1 Cautions	10
2.2 The environment conditions of installation	10
2.3 Installation direction and clearances	11
2.4 Encoder cable stress	12
<b>3. Wiring and signals</b>	<b>13</b>
3.1. Input power source circuit	14
3.2. Description of drive terminals and sockets	15
3.3. CN1 I/O socket	16
3.3.1. CN1 pin assignment	16
3.3.2. Shielding and ground for CN1 cable	17
3.3.3. CN1 pin name list	18
3.3.4. CN1 pin function description	19
3.3.5. CN1 DI signals	21
3.3.6. CN1 DO signals	26
3.3.7. Interface wiring diagram	30
3.4. CN2 Encoder signal wiring and description	34
3.5. CN3 communication port signal wiring and description	35
3.6. CN4 USB communication port	35
3.7. CN5 battery power socket	36
3.8. Standard wiring method	37
3.8.1. Wiring diagram of position control(Pr Mode)	38
3.8.2. Wiring diagram of position control(Pt Mode)	39
3.8.3. Wiring diagram of speed control(S Mode)	40
3.8.4. Wiring diagram of torque control(T Mode)	41
<b>4. Startup</b>	<b>42</b>

4.1. Switching power on for the first time.....	42
4.1.1. Startup procedure .....	42
4.1.2. Wiring check .....	43
4.1.3. Ambient environment.....	44
4.2. Display and operation .....	45
4.3. Display flowchart .....	46
4.4. Status display .....	47
4.5. Diagnostic display .....	49
4.5.1. Indication of external I/O signals.....	50
4.5.2. DO forced output .....	51
4.5.3. Test operation .....	52
4.6. Automatic offset of analog input .....	55
4.7. Alarm display .....	56
4.8. Parameter display .....	57
4.9. Startup in various control modes .....	60
4.9.1. Startup in position control mode .....	60
4.9.2. Startup in speed control mode.....	61
4.9.3. Startup in torque control mode .....	63
<b>5. Parameters .....</b>	<b>64</b>
5.1. Parameter definition .....	64
5.2. Parameter list .....	65
5.3. Parameter details list.....	81
<b>6. Gain adjustment and control mode.....</b>	<b>122</b>
6.1. Different adjustment methods.....	122
6.2. Auto-gain tuning mode .....	124
6.3. Manual gain tuning mode .....	127
6.4. Interpolation mode.....	128
6.5. Torque control mode.....	129
6.5.1. Output proportion of maximum torque analog command.....	129
6.5.2. Torque analog command offset.....	130
6.5.3. Torque analog command smoothing.....	130
6.5.4. Torque limit of torque control mode.....	131
6.5.5. Speed limit of torque control mode .....	132
6.6. Speed control mode .....	133
6.6.1. Selection of speed command.....	133
6.6.2. Output speed of maximum speed analog command.....	134
6.6.3. Speed analog command smoothing .....	134
6.6.4. Torque limit of speed control mode .....	137

6.6.5. Adjustment of speed loop gain.....	138
6.6.6. Resonance and vibration suppression filter .....	140
6.6.7. Gain switch function.....	143
6.7. Position control mode .....	147
6.7.1. External pulse-train command (Pt mode) .....	147
6.7.2. Inner register command (Pr mode).....	149
6.7.3. Position command smoothing.....	150
6.7.4. Electronic gear.....	151
6.7.5. Torque limit of position control mode .....	153
6.7.6. Position loop gain .....	153
6.8. Control mode switch .....	154
6.8.1. Position/speed mode switch .....	155
6.8.2. Speed/torque hybrid mode .....	155
6.8.3. Torque/Position control mode switch .....	156
6.9. Other functions .....	157
6.9.1. Selection of brake resistor .....	157
6.9.2. Analog monitor output.....	160
6.9.3. Operation of electromagnetic brake interlock .....	162
<b>7. PR (procedure) sequence control introductions .....</b>	<b>163</b>
7.1. PR introduction.....	163
7.2. PR differences in SDA and SDE .....	163
7.3. DI/DO and sequences .....	164
7.4. Relevant parameter settings of PR.....	165
<b>8. Communication functions .....</b>	<b>172</b>
8.1. Communication interface and wiring .....	172
8.2. Relevant parameters of communication .....	173
8.3. Modbus protocol.....	174
8.4. Communication parameter write-in and read-out .....	181
<b>9. Troubleshooting.....</b>	<b>188</b>
9.1. Alarm list.....	188
9.2. Alarm cause and remedy.....	190
<b>10. Specifications .....</b>	<b>201</b>
10.1. Drive specifications.....	201
10.2. Drive dimensions .....	203
10.3. Motor specifications .....	206
10.3.1. Low inertia, small capacity motor specifications .....	206
10.3.2. Medium capacity, low inertia motor specifications .....	208
10.3.3. Medium capacity, medium inertia motor specifications .....	209

10.4. Motor dimensions .....	211
10.4.1. Dimensions of motors (3000rpm rated speed) .....	211
10.4.2. Dimensions of motors (2000rpm rated speed) .....	212
10.4.3. Motor shaft end specification .....	213
10.5. Motor characteristic .....	214
10.6. Overload protection .....	218
<b>11. Compliance with global standards.....</b>	<b>220</b>
11.1. About safety.....	220
11.2. Professional engineer .....	220
11.3. Standard compliance .....	220
11.4. Correct use .....	222
11.5. Inspection and maintenance.....	224
11.5.1. Basic inspection.....	224
11.5.2. Maintenance .....	224
11.5.3. Life of consumable components .....	224
<b>12. Appendix .....</b>	<b>225</b>
12.1. Options .....	225
12.2. Brake resistor.....	229
12.3. Parameter communication address .....	230
12.4. Version information .....	234

# 1. Product descriptions

## 1.1 Summary

The Shihlin SDE series general-purpose servo drive has higher performance and more functions compared to the previous Shihlin servo drives. The Shihlin SME series servo motor is equipped with 22-bit (4,194,304 pulses/rev) high resolution encoder. The servo drive has position, speed, and torque control modes. In the position control mode, the maximum pulse train of 4 Mpps is supported. There are 4 basic control modes: position mode with external command, position mode with inner command, speed mode, torque mode. Further, it can perform the control modes switched, e.g. position/speed mode switched, speed/torque mode switched and torque/position mode switched. Therefore, the SDE servo drive are suitable for the general industry machinery that require the high precision and smooth speed control, or machine tools, or tension control.

With the auto tuning gain function, the drive could automatically adjust the control gain according to the instant dynamic change of the user's machinery.

The SDE drives equip not only RS-485 serial communication but also the most convenient device "USB" which could be connected to the personal computer performing the parameter setting, test operation, gain adjustment, and others.

## 1.2 Drive model designation

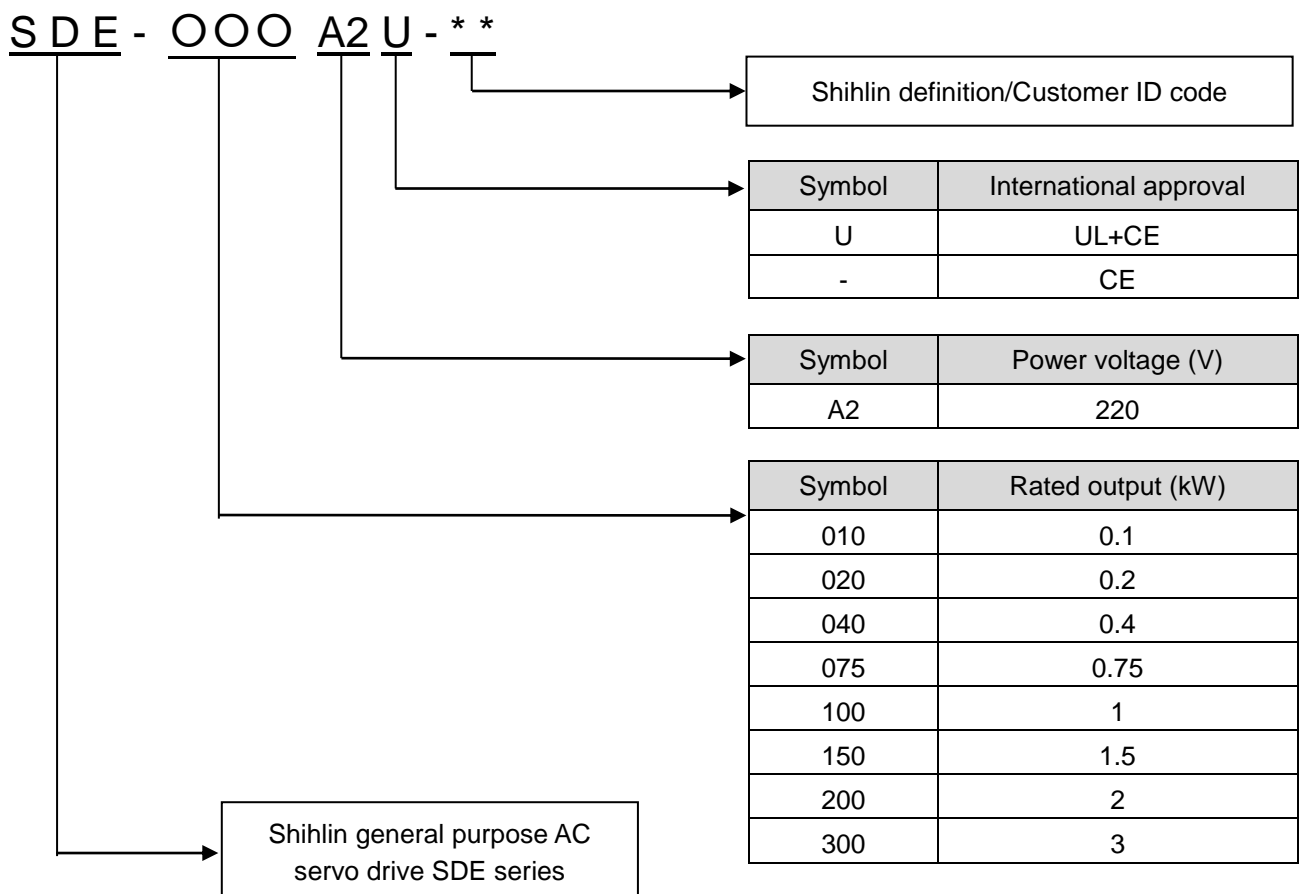

### 1.3 Motor model designation

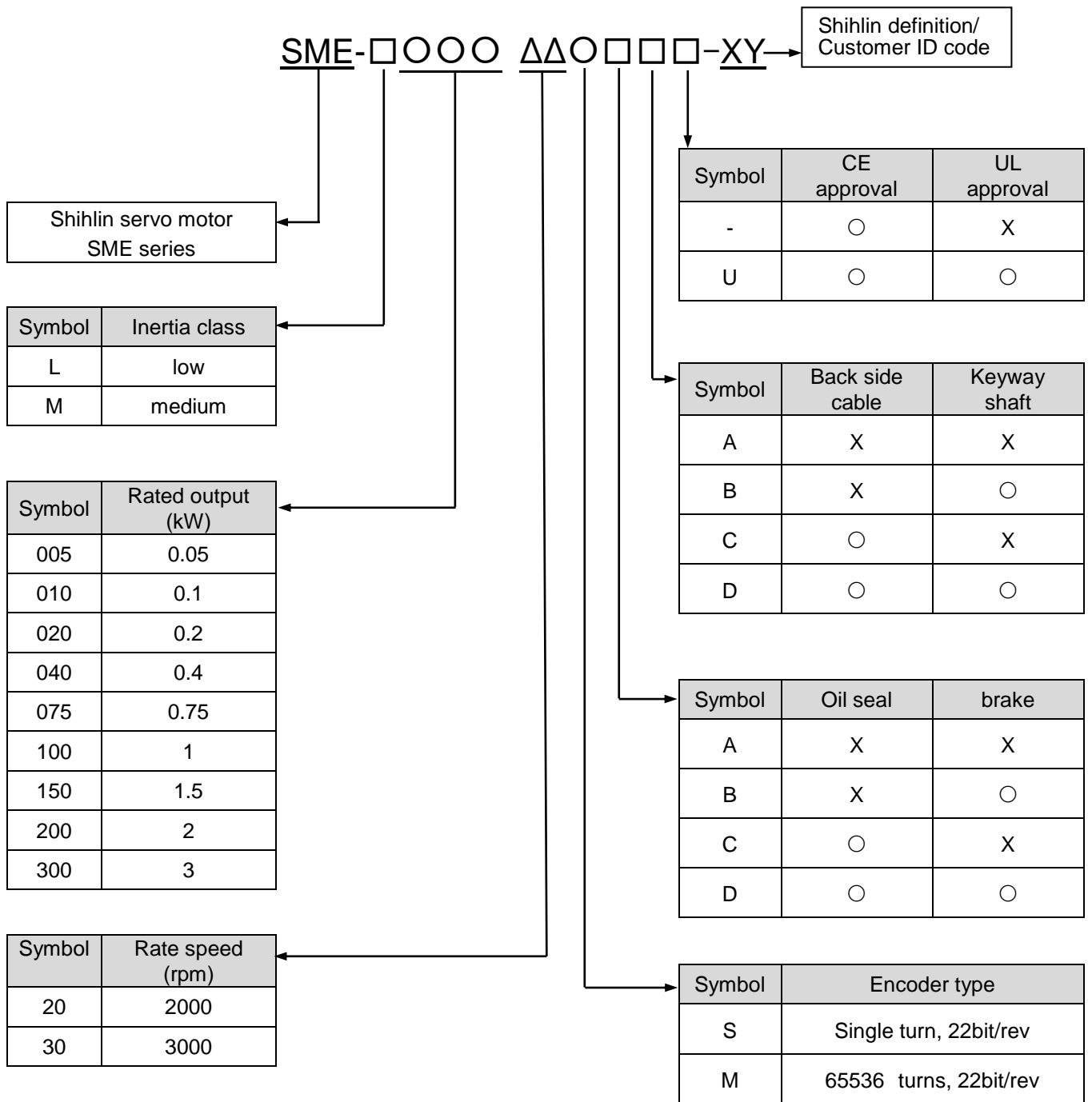

## 1.4 Drive rating plate

### (1) Rating plate diagram

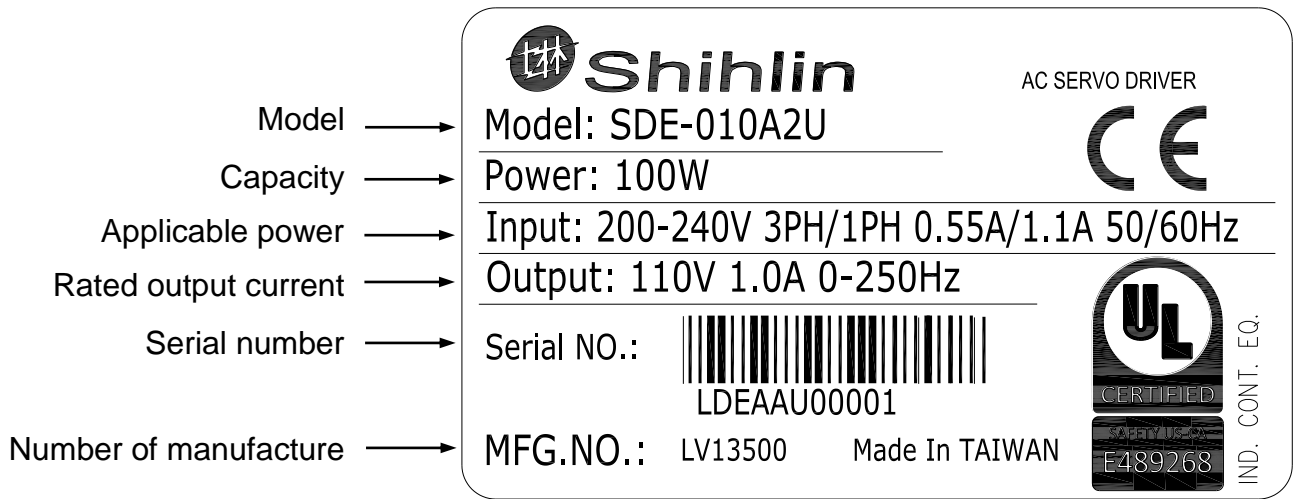

### (2) Serial number description

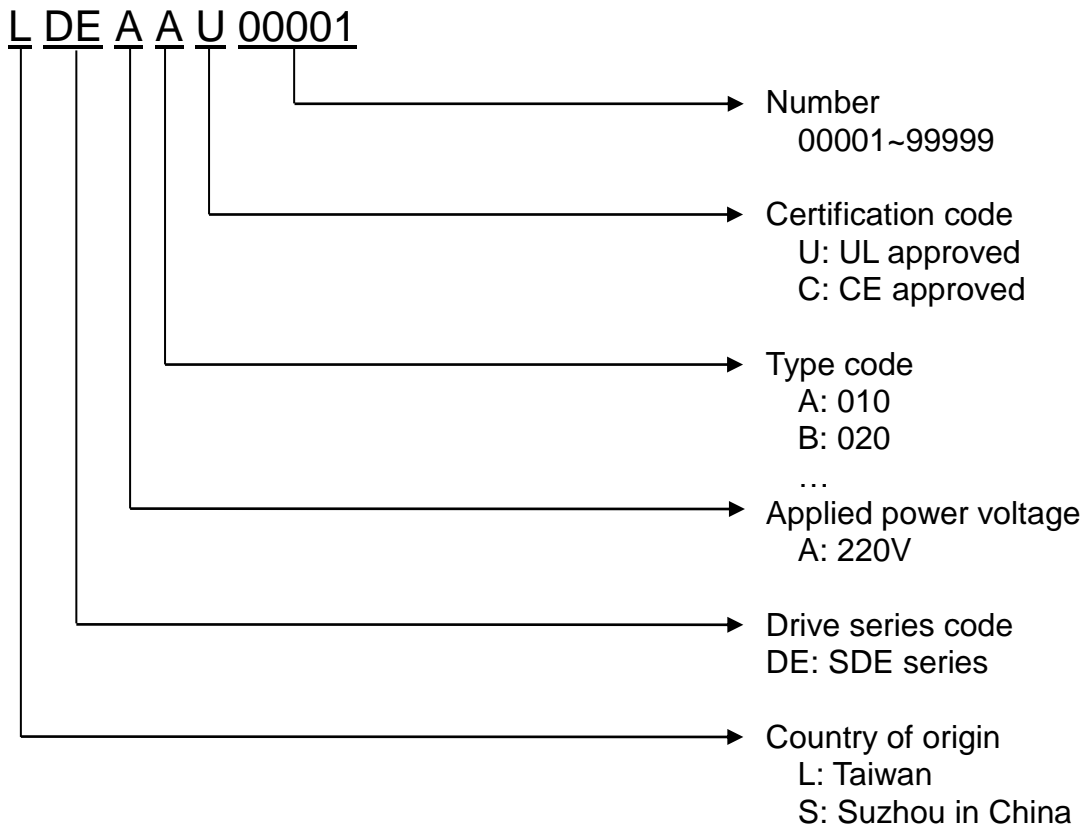

## 1.5 Motor rating plate

### (1) Rating plate diagram

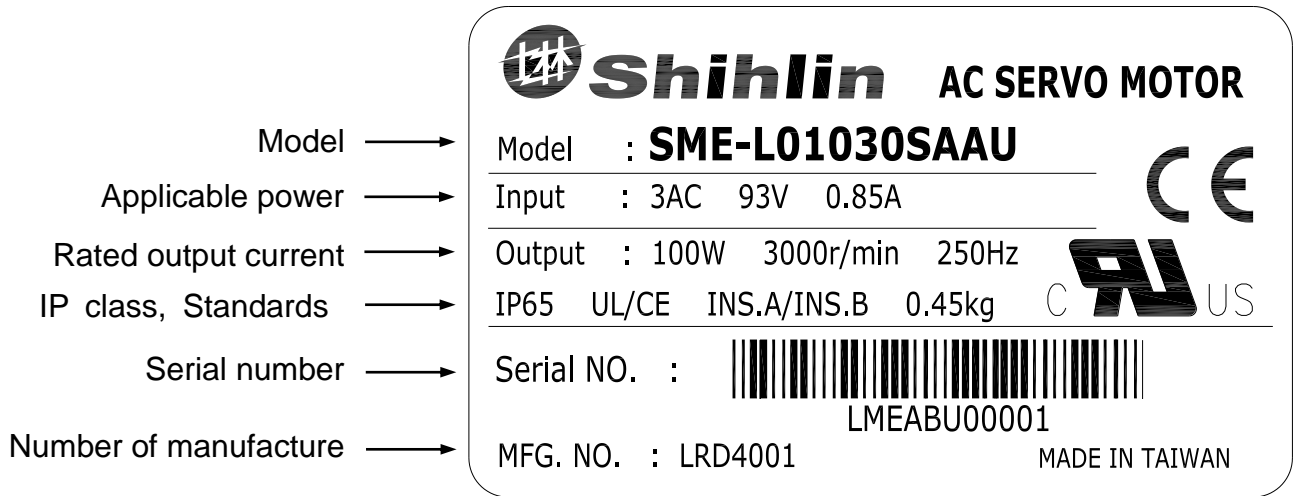

### (2) Serial number description

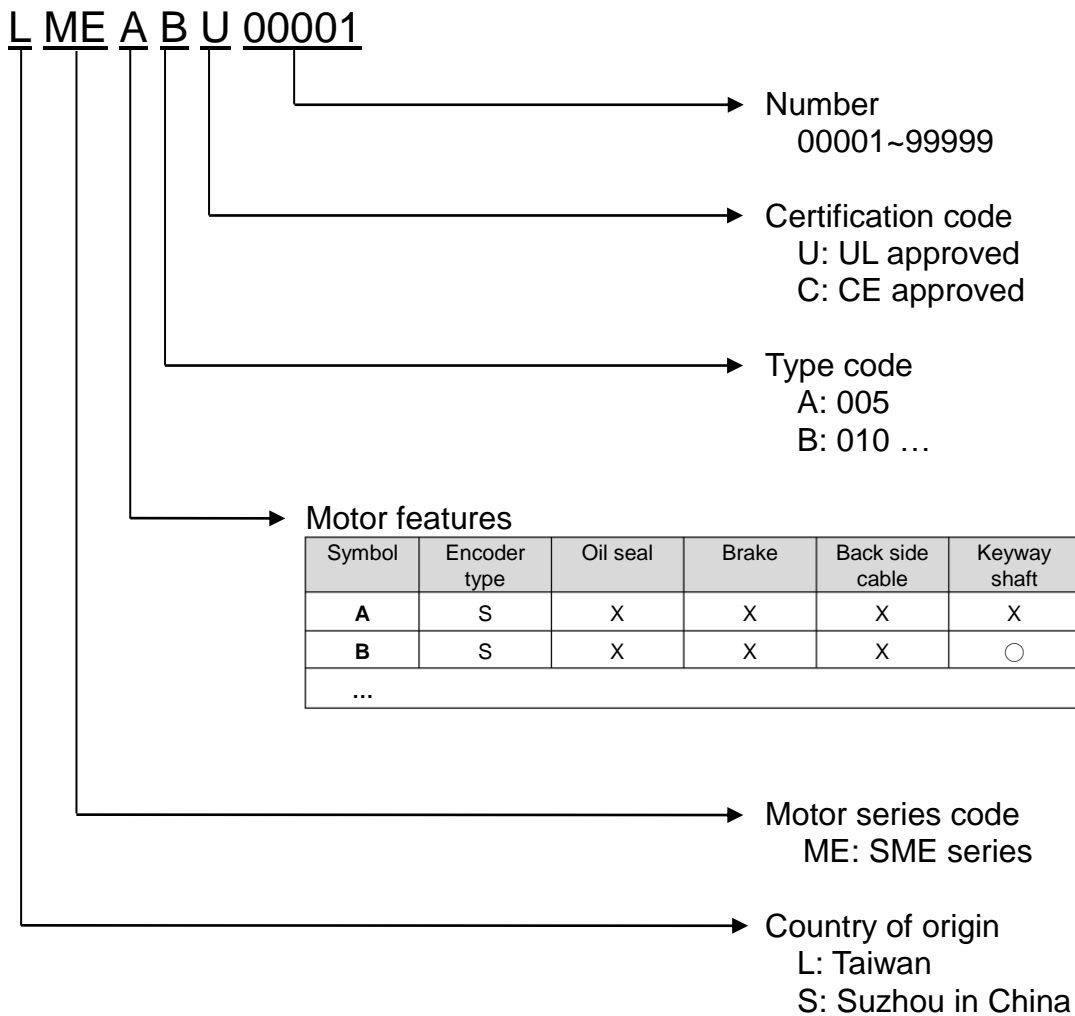



## 1.6 Function block diagram

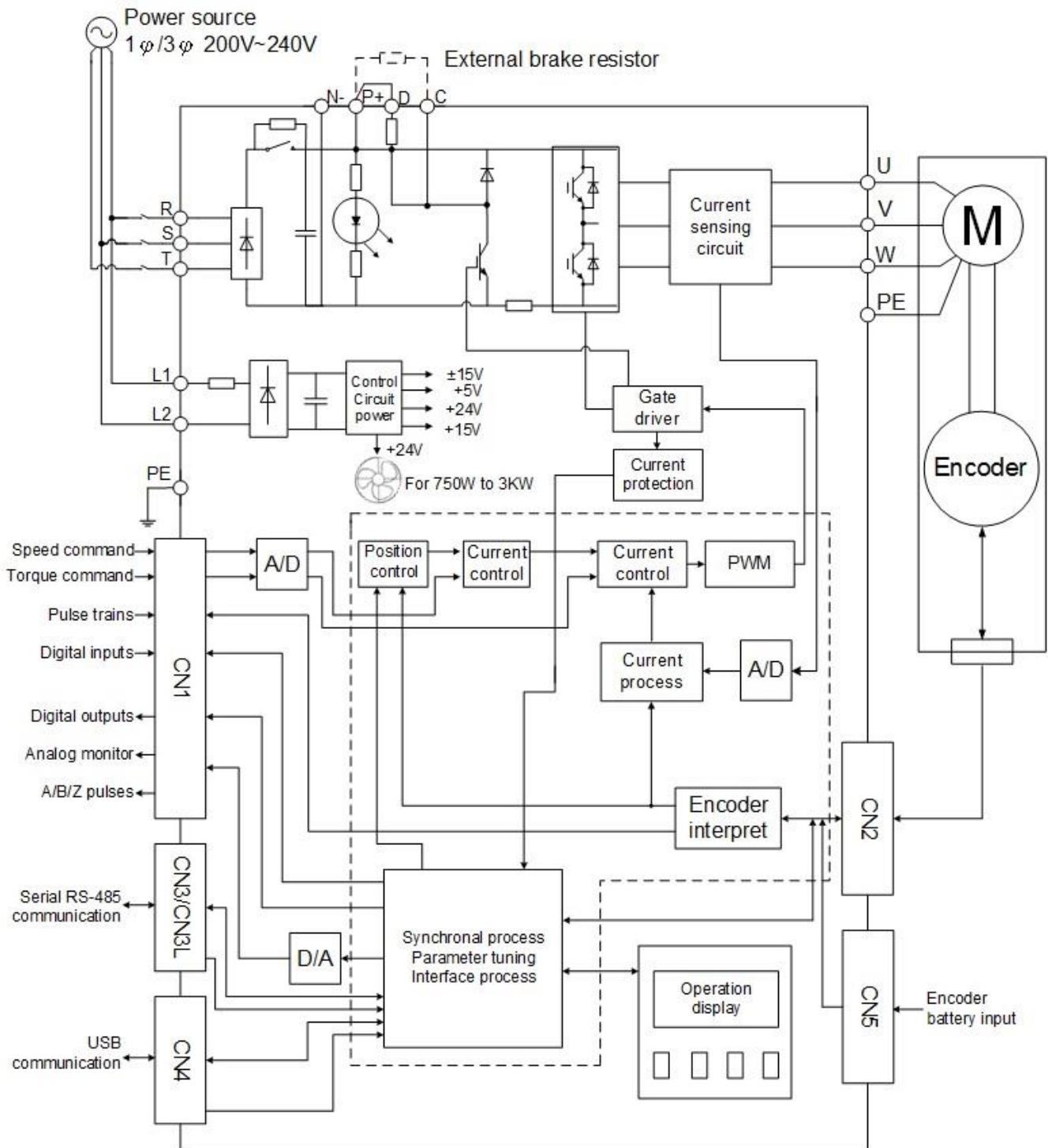

## 1.7 Combinations of Servo Drive and Servo Motor

Servo drive	Servo motor (Note)	
	Low inertia series	Medium inertia series
SDE-010A2	SME-L005	-
SDE-010A2	SME-L010	-
SDE-020A2	SME-L020	-
SDE-040A2	SME-L040	-
SDE-075A2	SME-L075	-
SDE-100A2	SME-L100	SME-M100
SDE-150A2	SME-L150	SME-M150
SDE-200A2	SME-L200	SME-M200
SDE-300A2	SME-L300	SME-M300

## 1.8 Servo control mode

Control Mode		Sign	Description
Basic	Position with external command	Pt	Drive receives the pulse commands of a superior controller then runs the motor to reach the assigned position.
	Position with inner command	Pr	According to the parameters setting and DI signals, drive runs the motor to reach the assigned position.
	Speed	S	Drive runs motor to attain the target speed. The command type which is an analog voltage or the inner registers could be switched by DI.
	Torque	T	The drive receives the commands to run the motor to generate the demanded torque. The command source is the analog voltage.
Switched		Pt-S	Pt/S is switched mutually via the LOP signal of DI.
		Pt-T	Pt/T is switched mutually via the LOP signal of DI.
		Pr-S	Pr/S is switched mutually via the LOP signal of DI.
		Pr-T	Pr/T is switched mutually via the LOP signal of DI.
		S-T	S/T is switched mutually via the LOP signal of DI.

## 1.9 Drive appearance and panel descriptions (1kW or less)

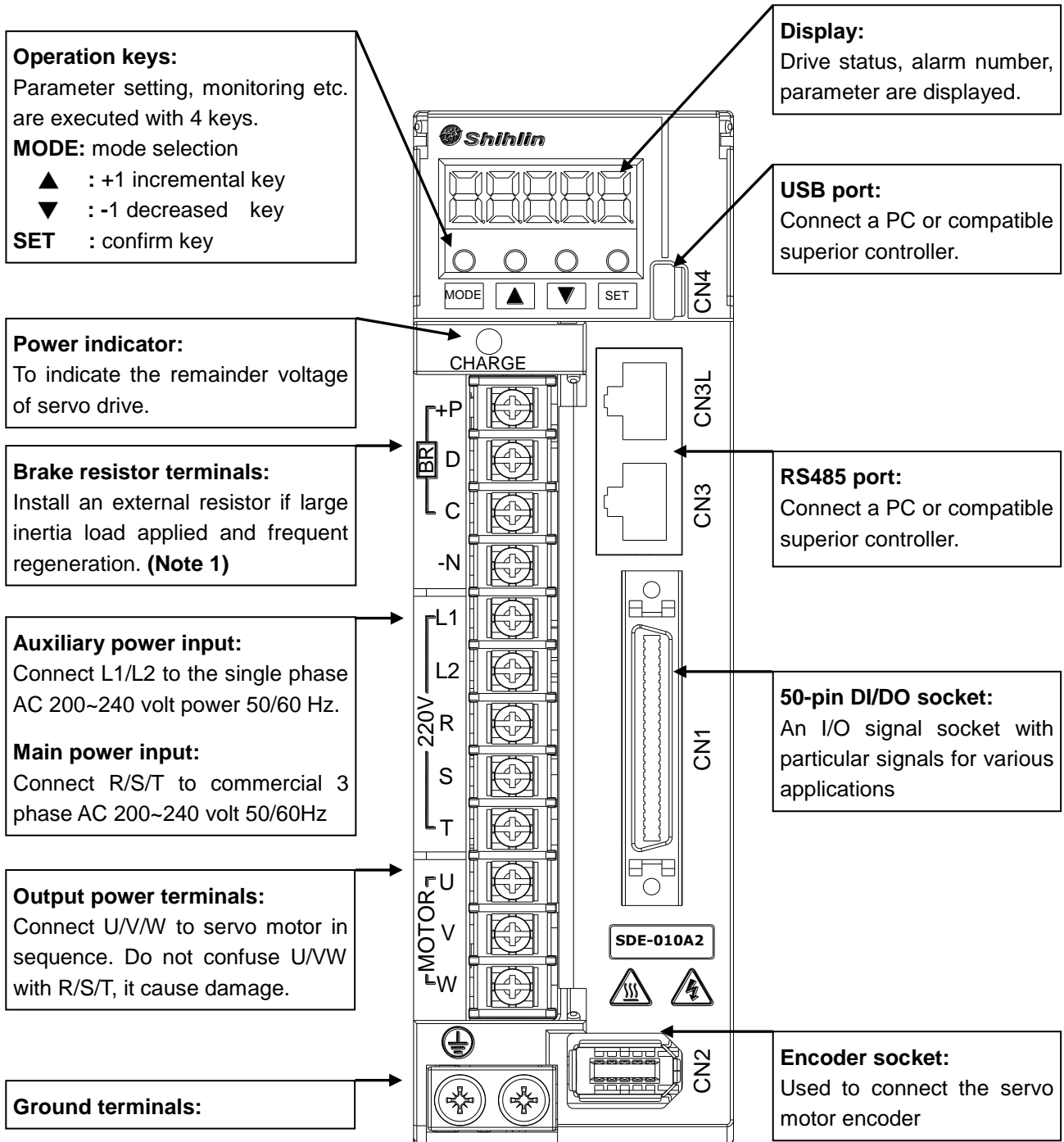

**Note:** 1. If an external brake resistor is applied, please make sure that “P” and “D” connect to the resistor, and make “P” and “C” open. If an active brake unit is applied, connect “P” and “N” to the unit and make “P” and “C” and “D” open.

## 1.10 Drive appearance and panel descriptions (1.5kW or greater)

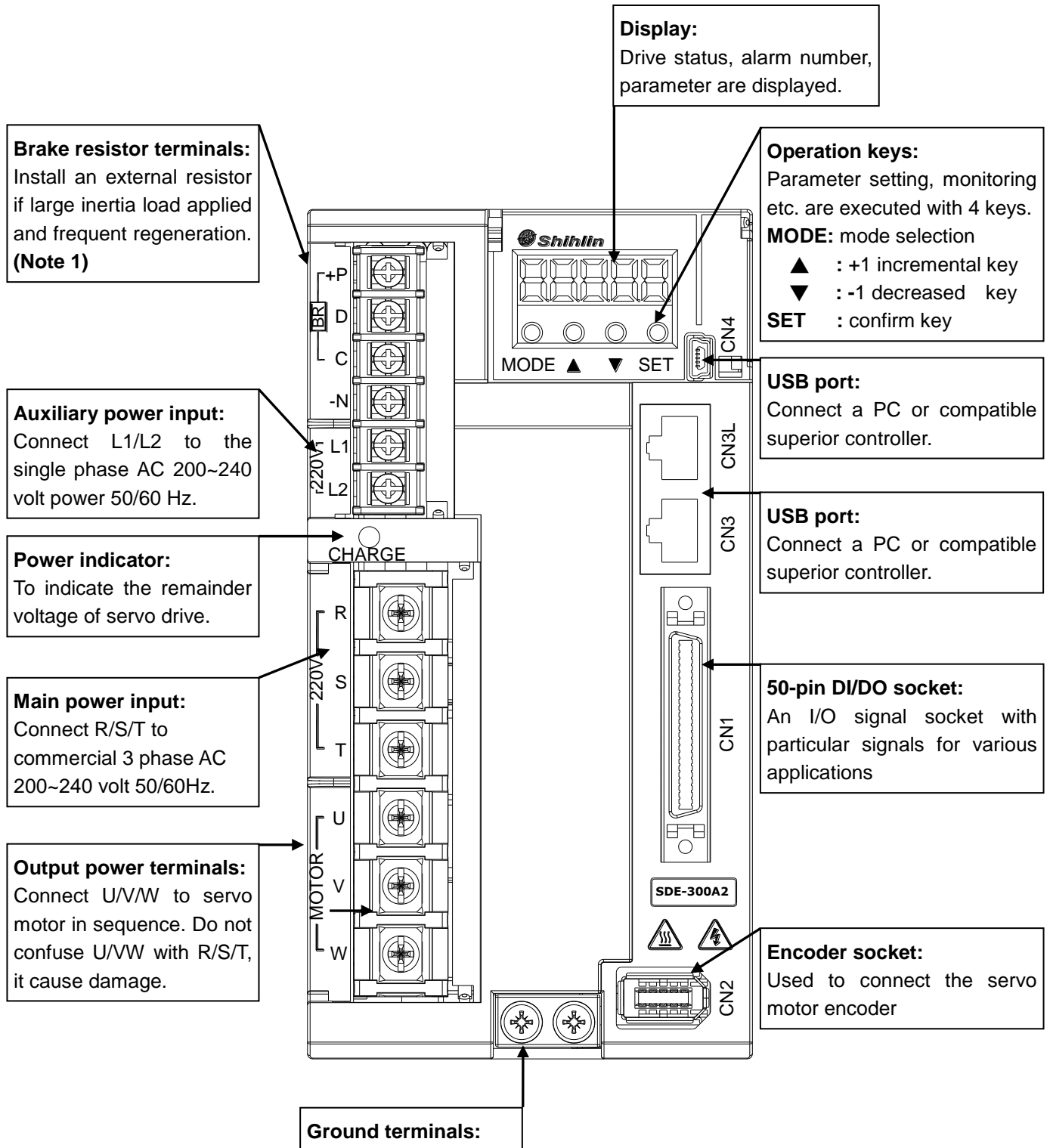

**Note:** 1. If an external brake resistor is applied, please make sure that “P” and “D” connect to the resistor, and make “P” and “C” open. If an active brake unit is applied, connect “P” and “N” to the unit and make “P” and “C” and “D” open.

## 1.11 Wires with peripheral equipment

Peripheral equipment connected to the servo drive is described as below. The wires with the peripheral equipment is an example for SDE-040 or smaller. Connectors, cables, options, and other necessary equipment should be ready so that users can set up the servo easily and start using it right away.

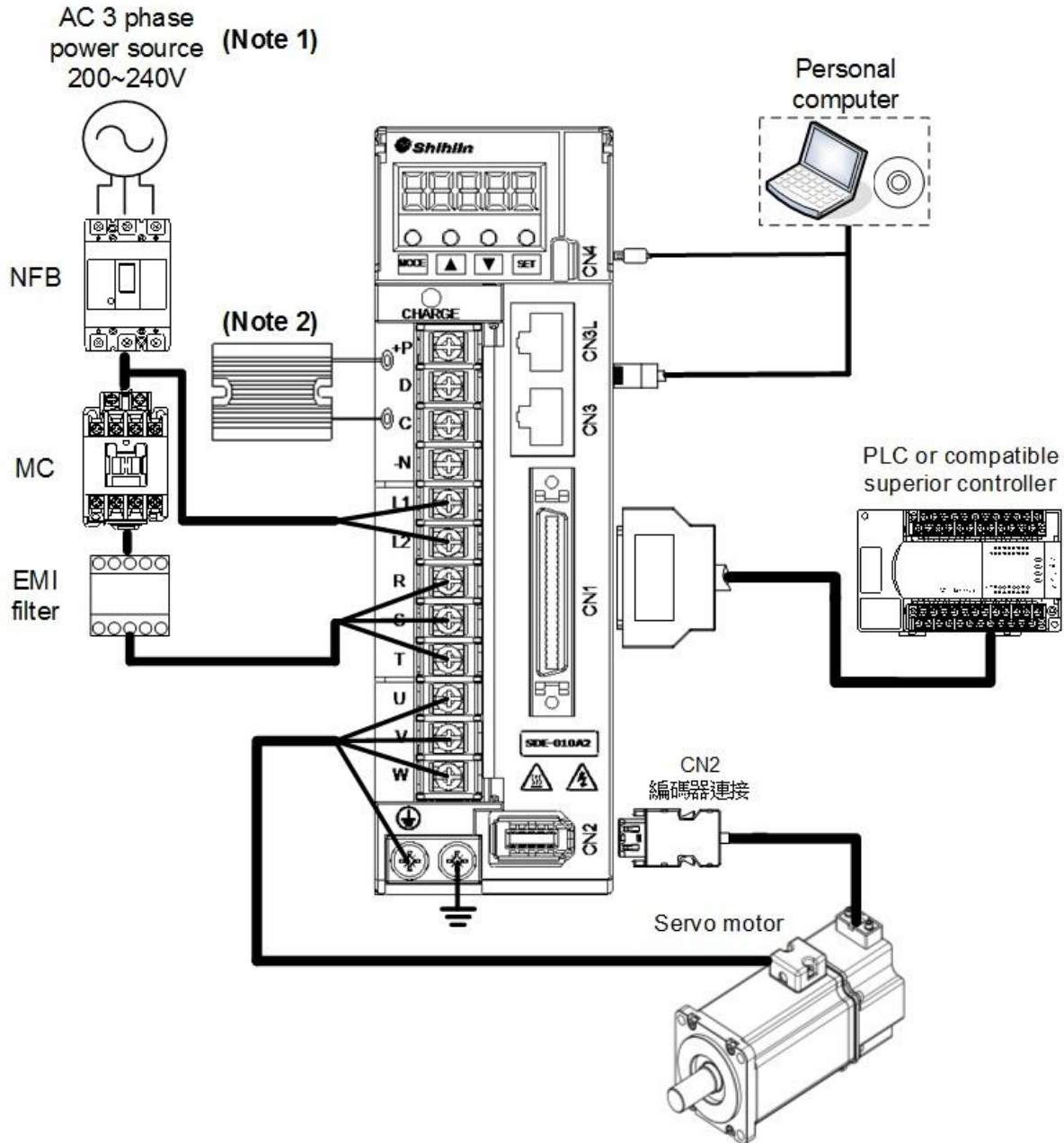

- Note:**
1. A single phase AC 200~240 volt power supply may be used with the servo drive of SDE-200A2 or less. In such case, connect the power supply to R and T. Leave S open.
  2. If an external brake resistor is applied, please make sure that "P" and "D" connect to the resistor, and make "P" and "C" open. Or an active brake unit is applied, connect "P" and "N" to the unit and make "P" and "C" and "D" open.

## 2. Installation

### 2.1 Cautions

- ◆ Do not install the product on inflammable matters or close to inflammable matters.
- ◆ Do not over tighten the wire between the drive and the motor.
- ◆ Do not place heavy objects on the top of the drive.
- ◆ Be sure to tight lock every screw when fixed the drive.
- ◆ Install the drive at a location where could bear the weight of the drive.
- ◆ Align the axle of the motor and the axle of the machinery device.
- ◆ Inflammable objects or conductive objects are not allowed inside the drive.
- ◆ Upgrade the diameter of the U/V/W wires and the encoder cable if the length between the drive and the motor is over 20m.
- ◆ Do not clog up the vent of the drive or breakdown may be occurred.
- ◆ Do not drop or clash the drive.
- ◆ Not try to run the drive which something has been damaged.
- ◆ Please refer to section 11.1 and 11.3 for drive and motor storage details.

### 2.2 The environment conditions of installation

The surrounding air temperature suitable for Shihlin drive is between 0 °C and 55 °C. If it is higher than 45 °C, the installation place with good ventilation or air conditioner is necessary. For a long-time operation, place the drive in an environment with temperature below 45°C to ensure the reliability of the drive. If the drives are installed in a distributor, make sure that its size and ventilation condition to prevent from over-heat. Make sure that mechanical vibration will not affect the electronic devices of the distributor. In addition, the use of Shihlin servo shall meet the following criteria:

- ◆ Locations without high-heating devices.
- ◆ Locations without floating dust and metal particles.
- ◆ Locations without corrosive, inflammable gas and liquid.
- ◆ Locations without water drops, steam, dust or oil dust.
- ◆ Locations without electromagnetic interference.
- ◆ Select a solid, vibration-free location.

## 2.3 Installation direction and clearances



- ◆ The drive must be installed in the specified direction. Otherwise, it may cause a malfunction.
- ◆ Leave specified clearances between the drive and the cabinet walls or other devices. Otherwise, it may cause a malfunction.

### (1) Installation direction

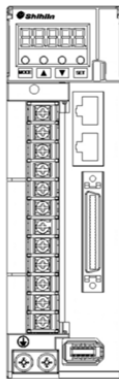

Correct

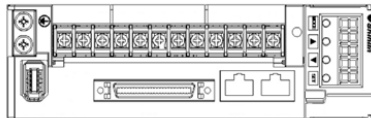

Incorrect

### (2) Installation clearances of one drive

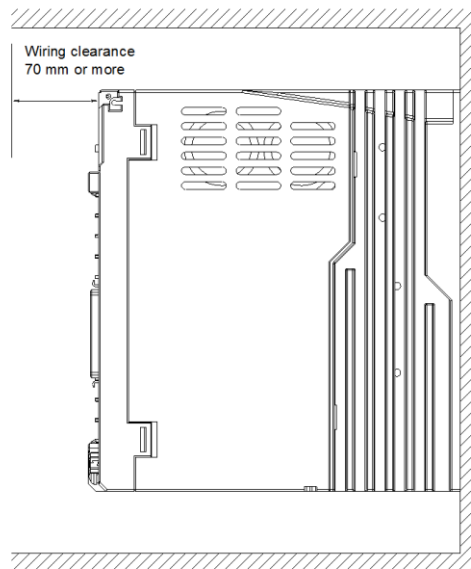
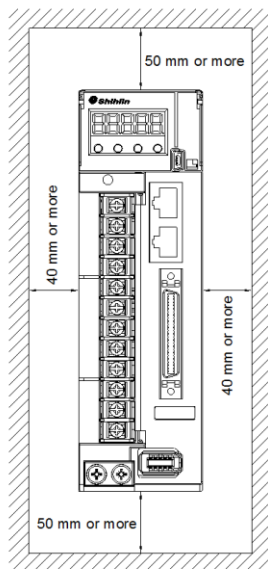

### (3) Installation clearances of two or more drives

Leave a large clearance between the top of the servo drive and the cabinet walls. When mounting the servo amplifiers closely, a cooling fan is helpful to prevent the internal temperature of the cabinet from exceeding the endurance of servo drive. In this case, keep the surrounding air temperature within

0 °C to 45 °C or use the servo amplifier with 75% or less of the effective load ratio.

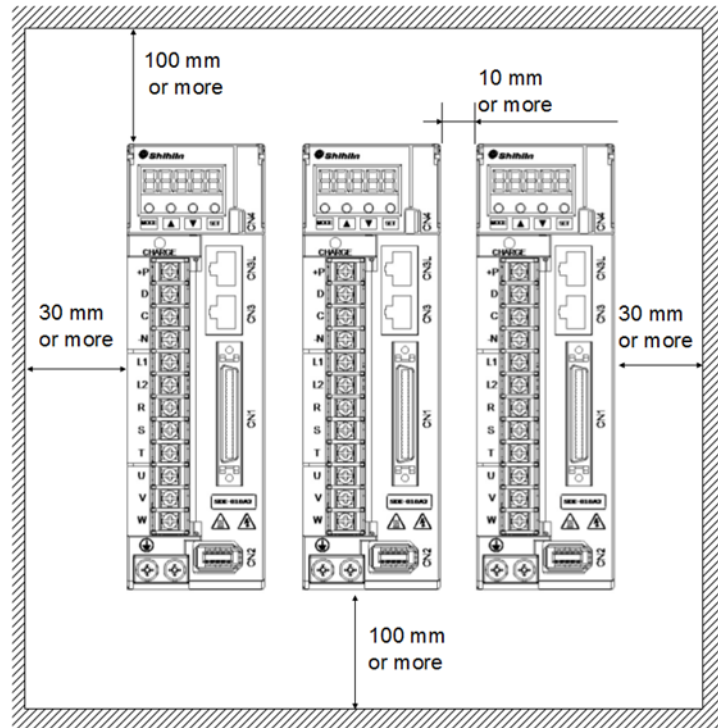

#### (4) Others

When using a regenerative device is used, consider a well ventilation so that the servo drive is not affected. Install the servo amplifier on a perpendicular wall in the correct vertical direction.

## 2.4 Encoder cable stress

- (1) The way of cable clamping must be fully examined so that bending stress and cable's own weight stress are not applied to the cable connection.
- (2) Any application which the servo motor moves, fix the cables (encoder, power supply, and brake) with having some slack from the connector connection part of the servo motor to avoid putting stress on the connector connection part. Use the optional encoder cable within the bending life range.
- (3) Use the power supply and brake wiring cables within the bending life of the cables.
- (4) Avoid any probability that the cable coat might be cut by sharp chips, rubbed by a machine corner or stamped by workers or vehicles.
- (5) For installation on a machine where the servo motor moves, the bending radius should be made as large as possible.



### 3. Wiring and signals



- ◆ Any person who wires should be fully capable to do the work.
- ◆ Before wiring, turn off the power and wait until the charge LED turns off. Then, confirm that the voltage between +P and -N is safe with a voltage meter. Otherwise, an electric shock may occur. In addition, when confirming the charge LED, always check it from the front of the servo drive.
- ◆ Make the ground of the servo drive and motor securely.
- ◆ Not to wire the servo drive and motor until they have been fixed. Otherwise, it may cause an electric shock.
- ◆ Be sure that the cable is completed, there is no any damaged. Otherwise, it may cause an electric shock.
- ◆ To avoid an electric shock, insulate the contacts of the power supply.



- ◆ Wire the drive correctly and securely. Otherwise, the servo motor may run unexpectedly, resulting in injury.
- ◆ Connect cables to the correct terminals. Otherwise, a burst, damage, etc. may occur.
- ◆ The surge absorbing diode installed for the DC relay should be fitted in the specified direction. Otherwise, the emergency stop and other protective circuits may not work.
- ◆ Do not modify the servo drive.
- ◆ Connect the servo drive power output (U, V, W) to the servo motor power input (U, V, W) directly. Do not let a magnetic contactor intervene. Otherwise, it may cause a malfunction.

### 3.1. Input power source circuit

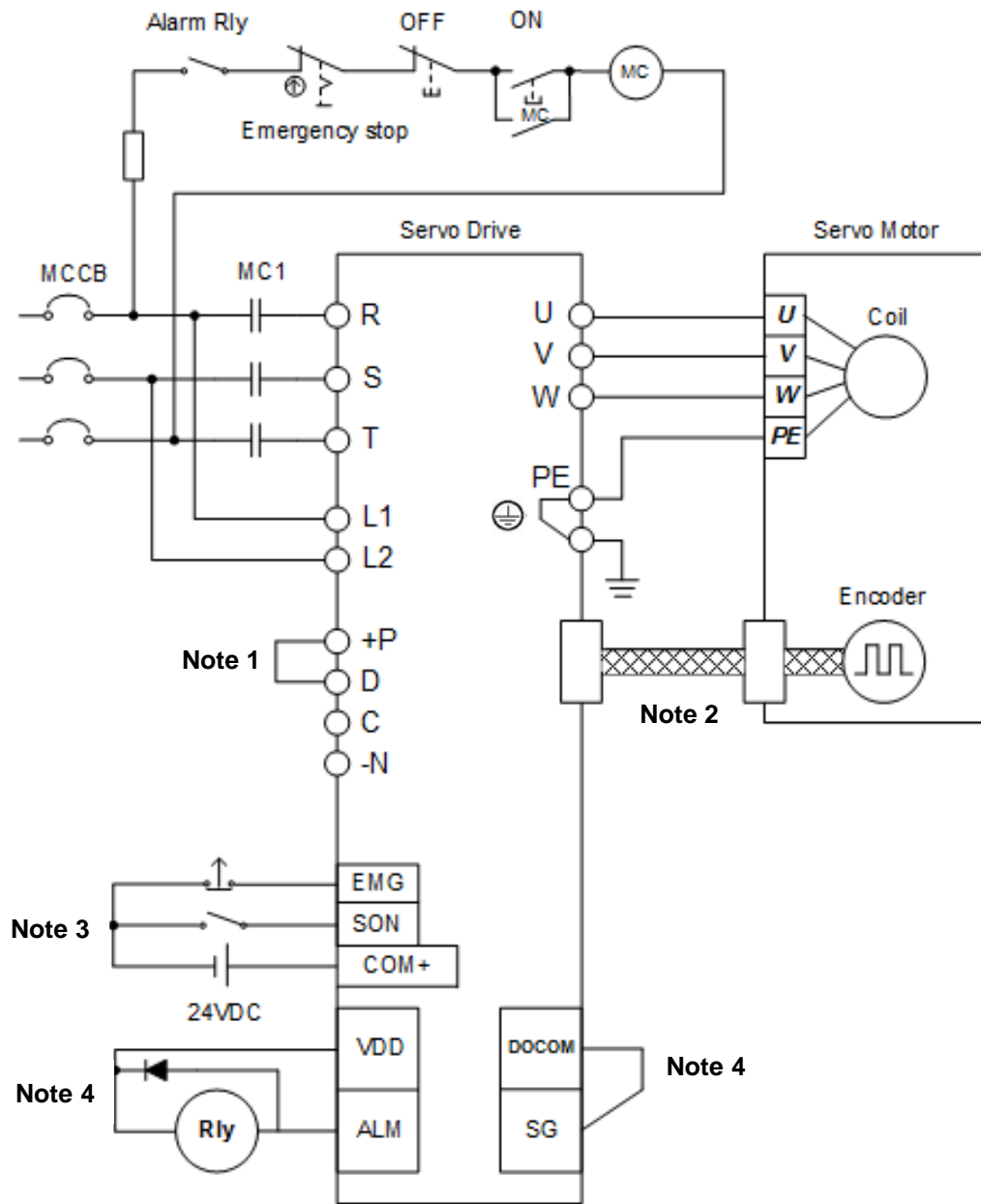

- Note:** 1. If an external brake resistor is applied, please make sure that “P” and “D” connect to the resistor, and make “P” and “C” open. Or an active brake unit is applied, connect “P” and “N” to the unit and make “P” and “C” and “D” open.
2. For the encoder cable, use of the option cable is recommended.
3. This diagram is for sink input diagram.
4. This diagram is for source output diagram, .make “DOCOM” and “SG” short together. And use “VDD” for a 24VDC power source.

### 3.2. Description of drive terminals and sockets

Name	Sign	Description								
Main power input terminal	R、S、T	Connect to 3-phase AC power source								
Control power input terminal	L1、L2	Connect to single phase AC power source								
Power output terminal	U、V、W	<table border="1"> <thead> <tr> <th>Terminal code</th> <th>Wire color</th> </tr> </thead> <tbody> <tr> <td>U</td> <td>Red</td> </tr> <tr> <td>V</td> <td>White</td> </tr> <tr> <td>W</td> <td>Black</td> </tr> </tbody> </table>	Terminal code	Wire color	U	Red	V	White	W	Black
Terminal code	Wire color									
U	Red									
V	White									
W	Black									
Brake resistor terminal	P、D、C	<table border="1"> <tbody> <tr> <td>External resistor</td> <td>P/C connected to resistor and P/D open.</td> </tr> <tr> <td>Built-in resistor</td> <td>P/D connect together and make P/C open.</td> </tr> </tbody> </table>	External resistor	P/C connected to resistor and P/D open.	Built-in resistor	P/D connect together and make P/C open.				
External resistor	P/C connected to resistor and P/D open.									
Built-in resistor	P/D connect together and make P/C open.									
Ground terminal		To connect the power ground with the motor ground.								
P: + terminal N: - terminal	P、N	When an active brake device is used for 1.5KW or above, please connect the + terminal of it to the drive's P terminal, the - terminal to the drive's N terminal. The active brake device is usually applied when the huge regenerative power produced by the servo motor in heavy duty.								
DI/DO connector	CN1	Connect to the host controller.								
Encoder socket	CN2	Connect to the encoder cable of servo motor.								
RS-485 port	CN3/CN3L	Connect CN3 to the superior device and CN3L to the inferior device.								
USB port	CN4	Connect to the USB port of PC.								

Follow the description below when wiring:

1. Keep the power lines R/S/T and U/V/W away from other signal lines at least 30cm.
2. Do not touch the power lines until the charge indicator goes out. When "power off", there is a large amount of electric charge in the aluminum capacitors inside the servo drive.
3. If a longer encoder cable is required, uses the twisted pairs cable and not to exceed 20m. Be sure to upgrade the diameter of wires to avoid signals attenuated when the wire's length greater than 20m.

### 3.3. CN1 I/O socket

#### 3.3.1. CN1 pin assignment

The CN1 equips with 12 digital inputs (DI) and 6 digital outputs (DO) which make the application with the host controller more flexible. The DI relevant parameters are PD02~PD09, PD21~PD24. The DO relevant parameters are PD10~PD14, PD26. In addition, it affords encoder differential output signals, torque analog command input, speed analog command input. The CN1 pin diagram is presented as follows.

##### (1) CN1 socket (drive side)

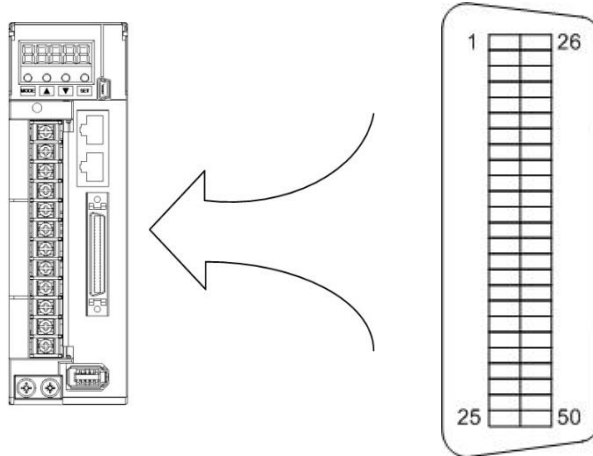

##### (2) CN1 connector (cabled side)

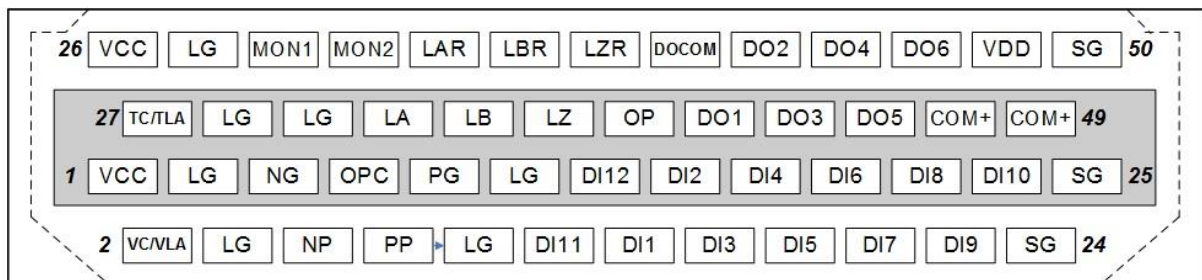
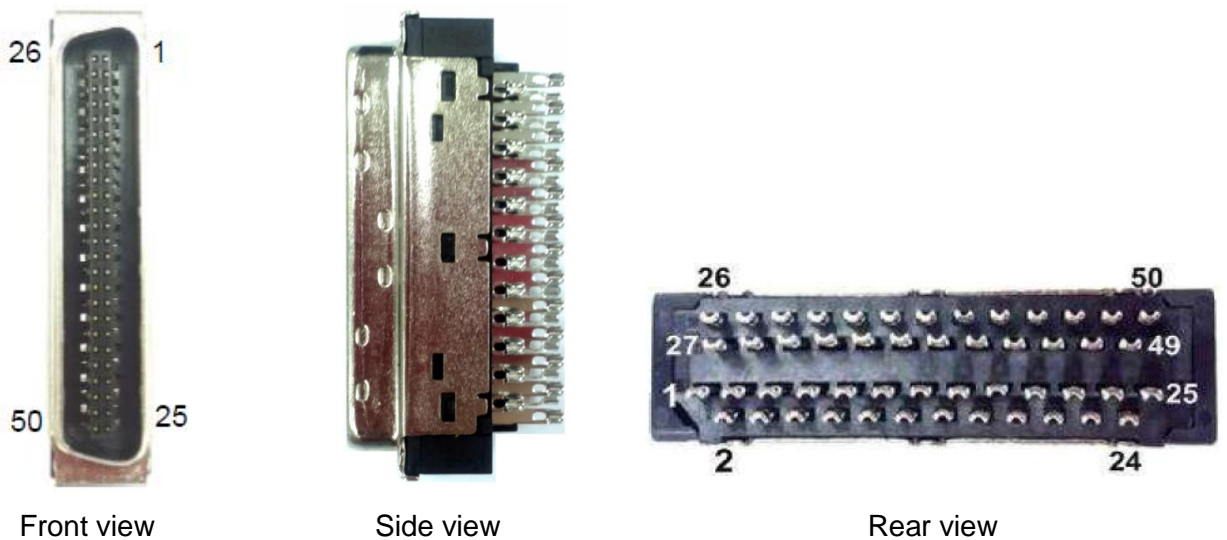

CN1 compatible connector pin order

### 3.3.2. Shielding and ground for CN1 cable

For the CN1 cable connector, securely connect the cable braid shield to the frame of CN1 connector. The CN1 cable connector pin assignment should be as viewed from the CN1 socket of servo drive. The connection of CN1 cable shielding is described as follows.

#### (1) Choose the proper cable

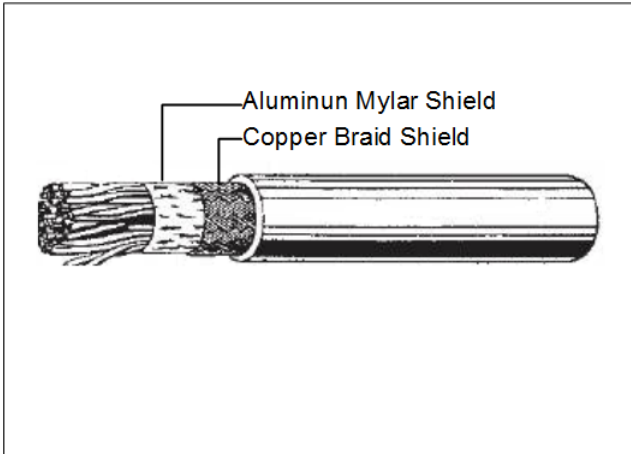

A cable with double shield is recommended.

#### (2) Fix the copper braid shield of cable.

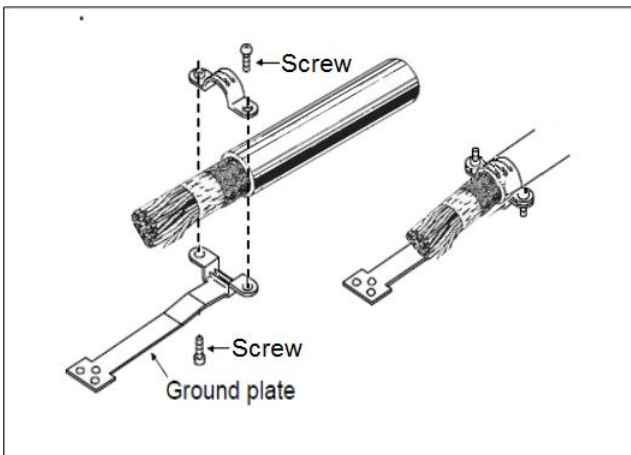

Lock the copper braid shield of cable on the ground plate with screws.

#### (3) Confirm the connection between the ground plate and the metal frame of CN1 connector.

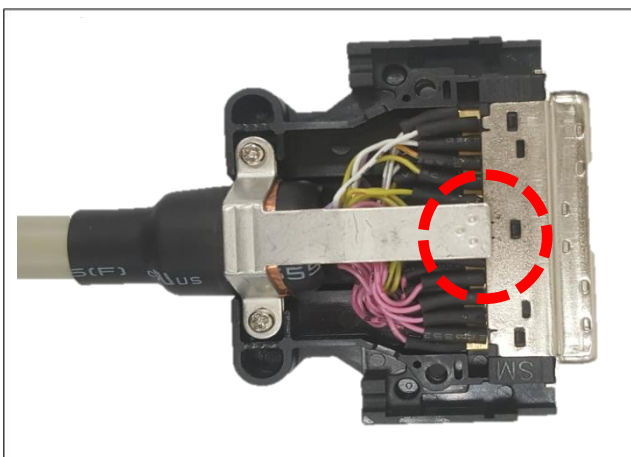

Make sure that the ground plate and the metal frame both in CN1 connector are connected well.

### 3.3.3. CN1 pin name list

2	VC/VLA	Speed analog command / limit
4	LG	Analog I/O ground
6	NP	Forward/ reverse rotation pulse
8	PP	Forward/ reverse rotation pulse
10	LG	Analog I/O ground
12	DI11	Digital input 11
14	DI1	Digital input 1
16	DI3	Digital input 3
18	DI5	Digital input 5
20	DI7	Digital input 7
22	DI9	Digital input 9
24	SG	Digital I/O signal ground
1	VCC	+15V power output
3	LG	Analog I/O ground
5	NG	Forward/ reverse rotation pulse
7	OPC	Open collector power
9	PG	Forward/ reverse rotation pulse
11	LG	Analog I/O ground
13	DI12	Digital input 12
15	DI2	Digital input 2
17	DI4	Digital input 4
19	DI6	Digital input 6
21	DI8	Digital input 8
23	DI10	Digital input 10
25	SG	Digital I/O signal ground
27	TC/TLA	Torque analog command / limit
29	LG	Analog I/O ground
31	LG	Analog I/O ground
33	LA	Encoder A pulse output
35	LB	Encoder B pulse output
37	LZ	Encoder Z pulse output
39	OP	Encoder Z pulse output (open collector)
41	DO1	Digital output 1
43	DO3	Digital output 3
45	DO5	Digital output 5
47	COM+	Digital Input midway
49	COM+	Digital Input midway
26	VCC	+15V power output
28	LG	Analog I/O ground
30	MON1	Analog monitor output 1
32	MON2	Analog monitor output 2
34	LAR	Encoder A pulse reverse output
36	LBR	Encoder B pulse reverse output
38	LZR	Encoder Z pulse reverse output
40	DOCOM	Digital Output midway
42	DO2	Digital output 2
44	DO4	Digital output 4
46	DO6	Digital output 6
48	VDD	+24V power output (digital I/O)
50	SG	Digital I/O signal ground

### 3.3.4. CN1 pin function description

There are 50 pins in CN1. Every pin and its default function are described as below. Some pin functions are varied depending on the control mode.

Pin name	Sign	Pin NO	Function description	Mode (Note)
+15V power output	VCC	CN1_1 CN1_26	There is a +15V between VCC and LG. It could be used as an analog power of TC, TLA, VC and VLA.	ALL
Speed analog command/limit	VC/VLA	CN1_2	Apply -10V~+10V between VC and LG in speed mode, the motor will run the PC12 speed proportionally at $\pm 10V$ .  Apply -10V~+10V between VC and LG in torque mode, the motor will run the PC12 speed proportionally at $\pm 10V$ .	S,T
Analog I/O ground	LG	CN1_3 CN1_4 CN1_10 CN1_11 CN1_28 CN1_29 CN1_31	The common ground of VC, VLA, TC, TLA, OP, MOM1, MON2. Each pin inside the drive is connected together.	ALL
Torque analog command/limit	TC/TLA	CN1_27	Apply -10V~+10V between TC and LG, the motor torque generated will be the PC13 value proportionally at $\pm 10V$ .  As TLA is valid, motor generated torque would be limited according to proportion of rated torque to applied voltage. The applied voltage range on TLA-LG is 0 ~ +10V.	Pt, Pr, S
Forward/reverse rotation pulse	NG	CN1_5	Open collector type: (Max. frequency 200Kpps) Signals on PP-SG means "forward command". Signals on NP-SG means "reverse command".	Pt
	NP	CN1_6		
	PP	CN1_8	Differential line driver (Max. frequency 500Kpps) Signals on PP-PG means "forward command". Signals on NP-NG means "reverse command".	
	PG	CN1_9		
Open collector power	OPC	CN1_7	When pulse signals applied in open collector type; this pin provides 24V and SG is the ground.	ALL

Digital I/O signal ground	SG	CN1_24 CN1_25 CN1_50	The ground of SON, EMG, etc. Each pin inside the drive is connected together but separated from LG.	ALL
Analog output monitor 1	MON1	CN1_30	To output the voltage of PC14 setting value.	ALL
Analog output monitor 2	MON2	CN1_32	To output the voltage of PC14 setting value.	ALL
Encoder A pulse output (Differential signal)	LA	CN1_33	To generate the differential pulses of PA14 setting value in one turn. A $\pi/2$ delay between phase A and phase B.	ALL
	LAR	CN1_34		
Encoder B pulse output (Differential signal)	LB	CN1_35	The phase sequence of rotation and difference between phase A and phase B could be defined by the PA39 setting value.	
	LBR	CN1_36		
Encoder Z pulse output (Differential signal)	LZ	CN1_37	The OP output signals are transformed into differential line driver.	
	LZR	CN1_38		
Encoder Z pulse output (Open collector)	OP	CN1_39	When one revolution completed of motor, one pulse is outputted.	ALL
Digital input midway	COM+	CN1_47 CN1_49	When +24V built-in power is applied as the source of input signals, this pin should be connected to VDD.	ALL
Digital output midway	DOCOM	CN1_40	Common of output signal. It is separated from LG. For sink type, connect LG or the “-” of 24V power. For source type, connect the “+” of 24V power.	ALL
+24V power output (for digital I/O)	VDD	CN1_48	There is a +24V±10% power source on +24Vdd - SG.	ALL

**Note:** Pt : Position mode with external command

Pr : Position with inner command

S : Speed mode

T : Torque mode



### 3.3.5. CN1 DI signals

There are 36 digital input functions could be assigned to the particular DI pin by the modification of PD02 to PD09, PD21 to PD24. The value from 0x01 to 0x24 is defined as the function described below.

Signal function	Sign	Value	Functions/Applications description	Control mode
Servo ON	SON	0x01	Power on the drive and make SON-SG short-circuit to ready (the shaft is locked). Make SON-SG open-circuit to release (the shaft is rotatable). A virtual "Servo ON" could be achieved by the PD01 set as □□□1.(Normal ON)	ALL
Reset	RES	0x02	A short-circuit duration over 50mS on RES-SG would recover from an abnormal alarm status. Some abnormal cases would not be recovered(refer to section 11.1). Set the PD20 as □□□1, the function of reset would not work.	ALL
Proportion control	PC	0x03	A short-circuit on PC-SG would switch the proportion-integral controller to the proportion controller (speed control) . When motor in static, it outputs torque to resist the external disturbance which even only 1 pulse revolution. Once the position is done, to prevent from unnecessary jitter of motor shaft, please switch to the proportion controller.	Pt, Pr, S
Torque limit option	TL	0x04	Open TL-SG to make inner torque limit 1 valid(PA05), or turn TL-SG on to make analog torque limit(TLA) valid. For details, refer to section 6.3.4.	Pt, Pr, S
Inner torque limit option	TL1	0x05	Turn TL1-SG on to make inner torque limit 2 valid(PC25). For details, refer to section 6.3.4.	ALL

Speed option 1	SP1	0x06	<p>&lt; Speed control mode &gt; Used to select the speed command. When using SP3, make it usable by making the setting of PD02~PD09.</p> <table border="1" data-bbox="616 286 1334 752"> <thead> <tr> <th rowspan="2">Setting of PD02~PD09</th> <th colspan="3">(Note)Input signals</th> <th rowspan="2">Speed command</th> </tr> <tr> <th>SP3</th> <th>SP2</th> <th>SP1</th> </tr> </thead> <tbody> <tr> <td rowspan="4">When speed option (SP3) is not used. (initial status)</td> <td>0</td> <td>0</td> <td>0</td> <td>Speed analog command (VC)</td> </tr> <tr> <td>0</td> <td>0</td> <td>1</td> <td>Inner speed command 1 (PC05)</td> </tr> <tr> <td>0</td> <td>1</td> <td>0</td> <td>Inner speed command 2 (PC06)</td> </tr> <tr> <td>0</td> <td>1</td> <td>1</td> <td>Inner speed command 3 (PC07)</td> </tr> <tr> <td rowspan="7">When speed option (SP3) is made valid.</td> <td>1</td> <td>0</td> <td>0</td> <td>Speed analog command (VC)</td> </tr> <tr> <td>1</td> <td>0</td> <td>1</td> <td>Inner speed command 1 (PC05)</td> </tr> <tr> <td>1</td> <td>1</td> <td>0</td> <td>Inner speed command 2 (PC06)</td> </tr> <tr> <td>1</td> <td>1</td> <td>1</td> <td>Inner speed command 3 (PC07)</td> </tr> <tr> <td>1</td> <td>0</td> <td>0</td> <td>Inner speed command 4 (PC08)</td> </tr> <tr> <td>1</td> <td>0</td> <td>1</td> <td>Inner speed command 5 (PC09)</td> </tr> <tr> <td>1</td> <td>1</td> <td>0</td> <td>Inner speed command 6 (PC10)</td> </tr> <tr> <td>1</td> <td>1</td> <td>1</td> <td>Inner speed command 7 (PC11)</td> </tr> </tbody> </table> <p>Note. 0: off (with SG) 1: on (with SG)</p>	Setting of PD02~PD09	(Note)Input signals			Speed command	SP3	SP2	SP1	When speed option (SP3) is not used. (initial status)	0	0	0	Speed analog command (VC)	0	0	1	Inner speed command 1 (PC05)	0	1	0	Inner speed command 2 (PC06)	0	1	1	Inner speed command 3 (PC07)	When speed option (SP3) is made valid.	1	0	0	Speed analog command (VC)	1	0	1	Inner speed command 1 (PC05)	1	1	0	Inner speed command 2 (PC06)	1	1	1	Inner speed command 3 (PC07)	1	0	0	Inner speed command 4 (PC08)	1	0	1	Inner speed command 5 (PC09)	1	1	0	Inner speed command 6 (PC10)	1	1	1	Inner speed command 7 (PC11)	S,T
Setting of PD02~PD09	(Note)Input signals				Speed command																																																									
	SP3	SP2	SP1																																																											
When speed option (SP3) is not used. (initial status)	0	0	0	Speed analog command (VC)																																																										
	0	0	1	Inner speed command 1 (PC05)																																																										
	0	1	0	Inner speed command 2 (PC06)																																																										
	0	1	1	Inner speed command 3 (PC07)																																																										
When speed option (SP3) is made valid.	1	0	0	Speed analog command (VC)																																																										
	1	0	1	Inner speed command 1 (PC05)																																																										
	1	1	0	Inner speed command 2 (PC06)																																																										
	1	1	1	Inner speed command 3 (PC07)																																																										
	1	0	0	Inner speed command 4 (PC08)																																																										
	1	0	1	Inner speed command 5 (PC09)																																																										
	1	1	0	Inner speed command 6 (PC10)																																																										
1	1	1	Inner speed command 7 (PC11)																																																											
Speed option 2	SP2	0x07	<p>&lt; Torque control mode &gt; Used to select the limit speed for operation. When using SP3, make it usable by making the setting of PD02~PD09.</p> <table border="1" data-bbox="616 936 1334 1379"> <thead> <tr> <th rowspan="2">Setting of PD02~PD09</th> <th colspan="3">(Note)Input signals</th> <th rowspan="2">Speed command</th> </tr> <tr> <th>SP3</th> <th>SP2</th> <th>SP1</th> </tr> </thead> <tbody> <tr> <td rowspan="4">When speed option (SP3) is not used. (initial status)</td> <td>0</td> <td>0</td> <td>0</td> <td>Speed analog command (VC)</td> </tr> <tr> <td>0</td> <td>0</td> <td>1</td> <td>Inner speed command 1 (PC05)</td> </tr> <tr> <td>0</td> <td>1</td> <td>0</td> <td>Inner speed command 2 (PC06)</td> </tr> <tr> <td>0</td> <td>1</td> <td>1</td> <td>Inner speed command 3 (PC07)</td> </tr> <tr> <td rowspan="7">When speed option (SP3) is made valid.</td> <td>1</td> <td>0</td> <td>0</td> <td>Speed analog command (VC)</td> </tr> <tr> <td>1</td> <td>0</td> <td>1</td> <td>Inner speed command 1 (PC05)</td> </tr> <tr> <td>1</td> <td>1</td> <td>0</td> <td>Inner speed command 2 (PC06)</td> </tr> <tr> <td>1</td> <td>1</td> <td>1</td> <td>Inner speed command 3 (PC07)</td> </tr> <tr> <td>1</td> <td>0</td> <td>0</td> <td>Inner speed command 4 (PC08)</td> </tr> <tr> <td>1</td> <td>0</td> <td>1</td> <td>Inner speed command 5 (PC09)</td> </tr> <tr> <td>1</td> <td>1</td> <td>0</td> <td>Inner speed command 6 (PC10)</td> </tr> <tr> <td>1</td> <td>1</td> <td>1</td> <td>Inner speed command 7 (PC11)</td> </tr> </tbody> </table> <p>Note. 0: off (with SG) 1: on (with SG)</p>	Setting of PD02~PD09	(Note)Input signals			Speed command	SP3	SP2	SP1	When speed option (SP3) is not used. (initial status)	0	0	0	Speed analog command (VC)	0	0	1	Inner speed command 1 (PC05)	0	1	0	Inner speed command 2 (PC06)	0	1	1	Inner speed command 3 (PC07)	When speed option (SP3) is made valid.	1	0	0	Speed analog command (VC)	1	0	1	Inner speed command 1 (PC05)	1	1	0	Inner speed command 2 (PC06)	1	1	1	Inner speed command 3 (PC07)	1	0	0	Inner speed command 4 (PC08)	1	0	1	Inner speed command 5 (PC09)	1	1	0	Inner speed command 6 (PC10)	1	1	1	Inner speed command 7 (PC11)	
Setting of PD02~PD09	(Note)Input signals				Speed command																																																									
	SP3	SP2	SP1																																																											
When speed option (SP3) is not used. (initial status)	0	0	0	Speed analog command (VC)																																																										
	0	0	1	Inner speed command 1 (PC05)																																																										
	0	1	0	Inner speed command 2 (PC06)																																																										
	0	1	1	Inner speed command 3 (PC07)																																																										
When speed option (SP3) is made valid.	1	0	0	Speed analog command (VC)																																																										
	1	0	1	Inner speed command 1 (PC05)																																																										
	1	1	0	Inner speed command 2 (PC06)																																																										
	1	1	1	Inner speed command 3 (PC07)																																																										
	1	0	0	Inner speed command 4 (PC08)																																																										
	1	0	1	Inner speed command 5 (PC09)																																																										
	1	1	0	Inner speed command 6 (PC10)																																																										
1	1	1	Inner speed command 7 (PC11)																																																											
Speed option 3	SP3	0x08	<p>&lt; Torque control mode &gt; Used to select the limit speed for operation. When using SP3, make it usable by making the setting of PD02~PD09.</p> <table border="1" data-bbox="616 936 1334 1379"> <thead> <tr> <th rowspan="2">Setting of PD02~PD09</th> <th colspan="3">(Note)Input signals</th> <th rowspan="2">Speed command</th> </tr> <tr> <th>SP3</th> <th>SP2</th> <th>SP1</th> </tr> </thead> <tbody> <tr> <td rowspan="4">When speed option (SP3) is not used. (initial status)</td> <td>0</td> <td>0</td> <td>0</td> <td>Speed analog command (VC)</td> </tr> <tr> <td>0</td> <td>0</td> <td>1</td> <td>Inner speed command 1 (PC05)</td> </tr> <tr> <td>0</td> <td>1</td> <td>0</td> <td>Inner speed command 2 (PC06)</td> </tr> <tr> <td>0</td> <td>1</td> <td>1</td> <td>Inner speed command 3 (PC07)</td> </tr> <tr> <td rowspan="7">When speed option (SP3) is made valid.</td> <td>1</td> <td>0</td> <td>0</td> <td>Speed analog command (VC)</td> </tr> <tr> <td>1</td> <td>0</td> <td>1</td> <td>Inner speed command 1 (PC05)</td> </tr> <tr> <td>1</td> <td>1</td> <td>0</td> <td>Inner speed command 2 (PC06)</td> </tr> <tr> <td>1</td> <td>1</td> <td>1</td> <td>Inner speed command 3 (PC07)</td> </tr> <tr> <td>1</td> <td>0</td> <td>0</td> <td>Inner speed command 4 (PC08)</td> </tr> <tr> <td>1</td> <td>0</td> <td>1</td> <td>Inner speed command 5 (PC09)</td> </tr> <tr> <td>1</td> <td>1</td> <td>0</td> <td>Inner speed command 6 (PC10)</td> </tr> <tr> <td>1</td> <td>1</td> <td>1</td> <td>Inner speed command 7 (PC11)</td> </tr> </tbody> </table> <p>Note. 0: off (with SG) 1: on (with SG)</p>	Setting of PD02~PD09	(Note)Input signals			Speed command	SP3	SP2	SP1	When speed option (SP3) is not used. (initial status)	0	0	0	Speed analog command (VC)	0	0	1	Inner speed command 1 (PC05)	0	1	0	Inner speed command 2 (PC06)	0	1	1	Inner speed command 3 (PC07)	When speed option (SP3) is made valid.	1	0	0	Speed analog command (VC)	1	0	1	Inner speed command 1 (PC05)	1	1	0	Inner speed command 2 (PC06)	1	1	1	Inner speed command 3 (PC07)	1	0	0	Inner speed command 4 (PC08)	1	0	1	Inner speed command 5 (PC09)	1	1	0	Inner speed command 6 (PC10)	1	1	1	Inner speed command 7 (PC11)	
Setting of PD02~PD09	(Note)Input signals				Speed command																																																									
	SP3	SP2	SP1																																																											
When speed option (SP3) is not used. (initial status)	0	0	0	Speed analog command (VC)																																																										
	0	0	1	Inner speed command 1 (PC05)																																																										
	0	1	0	Inner speed command 2 (PC06)																																																										
	0	1	1	Inner speed command 3 (PC07)																																																										
When speed option (SP3) is made valid.	1	0	0	Speed analog command (VC)																																																										
	1	0	1	Inner speed command 1 (PC05)																																																										
	1	1	0	Inner speed command 2 (PC06)																																																										
	1	1	1	Inner speed command 3 (PC07)																																																										
	1	0	0	Inner speed command 4 (PC08)																																																										
	1	0	1	Inner speed command 5 (PC09)																																																										
	1	1	0	Inner speed command 6 (PC10)																																																										
1	1	1	Inner speed command 7 (PC11)																																																											
Forward rotation activated	ST1	0x09	<p>Used to start the servo motor in the following directions:</p> <table border="1" data-bbox="632 1523 1334 1738"> <thead> <tr> <th colspan="2">(Note)Input signals</th> <th rowspan="2">Servo motor starting direction</th> </tr> <tr> <th>ST2</th> <th>ST1</th> </tr> </thead> <tbody> <tr> <td>0</td> <td>0</td> <td>Stop(servo lock)</td> </tr> <tr> <td>0</td> <td>1</td> <td>CCW</td> </tr> <tr> <td>1</td> <td>0</td> <td>CW</td> </tr> <tr> <td>1</td> <td>1</td> <td>Stop(servo lock)</td> </tr> </tbody> </table>	(Note)Input signals		Servo motor starting direction	ST2	ST1	0	0	Stop(servo lock)	0	1	CCW	1	0	CW	1	1	Stop(servo lock)	S																																									
(Note)Input signals		Servo motor starting direction																																																												
ST2	ST1																																																													
0	0	Stop(servo lock)																																																												
0	1	CCW																																																												
1	0	CW																																																												
1	1	Stop(servo lock)																																																												
Reverse rotation activated	ST2	0x0A	<p>Note. 0: off (with SG) 1: on (with SG)</p> <p>If both ST1 and ST2 are switched on or off during operation, the servo will be decelerated to a stop according to the value of PC18, and the motor will be locked. The activation of analog speed commands (VC) at 0V will not servo lock.</p>																																																											

Forward rotation option	RS1	0x0A	<p>Used to select any of the following servo motor torque generation directions:</p> <table border="1"> <thead> <tr> <th colspan="2">Input signals (Note)</th> <th rowspan="2">Torque generation direction</th> </tr> <tr> <th>RS2</th> <th>RS1</th> </tr> </thead> <tbody> <tr> <td>0</td> <td>0</td> <td>Torque is not generated.</td> </tr> <tr> <td>0</td> <td>1</td> <td>Forward rotation torque, reverse rotation regeneration</td> </tr> <tr> <td>1</td> <td>0</td> <td>Reverse rotation torque, forward rotation regeneration</td> </tr> <tr> <td>1</td> <td>1</td> <td>Torque is not generated.</td> </tr> </tbody> </table> <p>Note. 0: off (with SG), 1: on (with SG)</p>	Input signals (Note)		Torque generation direction	RS2	RS1	0	0	Torque is not generated.	0	1	Forward rotation torque, reverse rotation regeneration	1	0	Reverse rotation torque, forward rotation regeneration	1	1	Torque is not generated.	T	
Input signals (Note)		Torque generation direction																				
RS2	RS1																					
0	0	Torque is not generated.																				
0	1	Forward rotation torque, reverse rotation regeneration																				
1	0	Reverse rotation torque, forward rotation regeneration																				
1	1	Torque is not generated.																				
Reverse rotation option	RS2	0x09																				
Origin position	ORGP	0x0B	In position control with inner registers, this signal activated would assign current position to the origin.	Pr																		
Start Home moving	SHOM	0x0C	As this signal activated, drive runs motor to return the origin.	Pr																		
Electronic gear option 1	CM1	0x0D	<p>When using CM1 and CM2, make them usable by the setting of PD02~PD09. The combination of CM1 and CM2 gives you a choice of 4 numerators. CM1 and CM2 cannot be used in the absolute position detection system.</p> <table border="1"> <thead> <tr> <th colspan="2">Input signals (Note)</th> <th rowspan="2">Electronic gear molecule</th> </tr> <tr> <th>CM2</th> <th>CM1</th> </tr> </thead> <tbody> <tr> <td>0</td> <td>0</td> <td>The value of parameter PA07 (CMX)</td> </tr> <tr> <td>0</td> <td>1</td> <td>The value of parameter PC32(CMX2)</td> </tr> <tr> <td>1</td> <td>0</td> <td>The value of parameter PC33(CMX3)</td> </tr> <tr> <td>1</td> <td>1</td> <td>The value of parameter PC34(CMX4)</td> </tr> </tbody> </table> <p>Note. 0: off (with SG), 1: on (with SG)</p>	Input signals (Note)		Electronic gear molecule	CM2	CM1	0	0	The value of parameter PA07 (CMX)	0	1	The value of parameter PC32(CMX2)	1	0	The value of parameter PC33(CMX3)	1	1	The value of parameter PC34(CMX4)	Pt, Pr	
Input signals (Note)		Electronic gear molecule																				
CM2	CM1																					
0	0	The value of parameter PA07 (CMX)																				
0	1	The value of parameter PC32(CMX2)																				
1	0	The value of parameter PC33(CMX3)																				
1	1	The value of parameter PC34(CMX4)																				
Electronic gear option 2	CM2	0x0E																				
Clear	CR	0x0F	Turn CR on to clear the position control counter droop pulses on its leading edge. The pulse width should be 10mS or longer. When the PD18 setting is <input type="checkbox"/> <input type="checkbox"/> <input type="checkbox"/> 1, the pulse are always cleared while CR is on.	Pt, Pr																		
Gain switch option	CDP	0x10	When using this signal, make it usable by the setting of PD02~PD09. Turn CDP on to change the gain values into the multiplier of parameter PB14 to PB17.	ALL																		
Control mode switch	LOP	0x11	<p>&lt; Position/Speed control switch mode &gt; Used to select the control mode in the position/speed control switch mode.</p> <table border="1"> <thead> <tr> <th>(Note) LOP</th> <th>Control mode</th> </tr> </thead> <tbody> <tr> <td>0</td> <td>Position</td> </tr> <tr> <td>1</td> <td>Speed</td> </tr> </tbody> </table> <p>&lt; Speed/Torque control switch mode &gt; Used to select the control mode in the Speed/Torque control switch mode.</p> <table border="1"> <thead> <tr> <th>(Note) LOP</th> <th>Control mode</th> </tr> </thead> <tbody> <tr> <td>0</td> <td>Speed</td> </tr> <tr> <td>1</td> <td>Torque</td> </tr> </tbody> </table> <p>&lt; Torque/Position control switch mode &gt; Used to select the control mode in the Torque/Position control switch mode.</p> <table border="1"> <thead> <tr> <th>(Note) LOP</th> <th>Control mode</th> </tr> </thead> <tbody> <tr> <td>0</td> <td>Torque</td> </tr> <tr> <td>1</td> <td>Position</td> </tr> </tbody> </table> <p>Note. 0: off (with SG), 1: on (with SG)</p>	(Note) LOP	Control mode	0	Position	1	Speed	(Note) LOP	Control mode	0	Speed	1	Torque	(Note) LOP	Control mode	0	Torque	1	Position	Refer to Functions/Applications
(Note) LOP	Control mode																					
0	Position																					
1	Speed																					
(Note) LOP	Control mode																					
0	Speed																					
1	Torque																					
(Note) LOP	Control mode																					
0	Torque																					
1	Position																					

External emergency stop	EMG	0x12	Turn EMG off (open EMG-SG) to bring the motor to an emergency stop state, in which the electromagnetic brake is on. Turn EMG on (short EMG-SG) in the emergency stop state to reset that state. To set the value of PD01 as 1□□□, this signal would be normal on.	ALL																																																																								
Position command 1	POS1	0x13	<table border="1"> <thead> <tr> <th>Position</th> <th>POS6</th> <th>POS5</th> <th>POS4</th> <th>POS3</th> <th>POS2</th> <th>POS1</th> <th>CTRG</th> </tr> </thead> <tbody> <tr> <td>P0</td> <td>0</td> <td>0</td> <td>0</td> <td>0</td> <td>0</td> <td>0</td> <td>↑</td> </tr> <tr> <td>P1</td> <td>0</td> <td>0</td> <td>0</td> <td>0</td> <td>0</td> <td>1</td> <td>↑</td> </tr> <tr> <td colspan="8" style="text-align: center;">~</td> </tr> <tr> <td>P50</td> <td>1</td> <td>1</td> <td>0</td> <td>0</td> <td>1</td> <td>0</td> <td>↑</td> </tr> <tr> <td>P51</td> <td>1</td> <td>1</td> <td>0</td> <td>0</td> <td>1</td> <td>0</td> <td>↑</td> </tr> <tr> <td colspan="8" style="text-align: center;">~</td> </tr> <tr> <td>P62</td> <td>1</td> <td>1</td> <td>1</td> <td>1</td> <td>1</td> <td>0</td> <td></td> </tr> <tr> <td>P63</td> <td>1</td> <td>1</td> <td>1</td> <td>1</td> <td>1</td> <td>1</td> <td>↑</td> </tr> </tbody> </table> <p>Note. 0: off (with SG), 1: on (with SG)</p>	Position	POS6	POS5	POS4	POS3	POS2	POS1	CTRG	P0	0	0	0	0	0	0	↑	P1	0	0	0	0	0	1	↑	~								P50	1	1	0	0	1	0	↑	P51	1	1	0	0	1	0	↑	~								P62	1	1	1	1	1	0		P63	1	1	1	1	1	1	↑	Pr
Position	POS6	POS5		POS4	POS3	POS2	POS1	CTRG																																																																				
P0	0	0		0	0	0	0	↑																																																																				
P1	0	0		0	0	0	1	↑																																																																				
~																																																																												
P50	1	1		0	0	1	0	↑																																																																				
P51	1	1		0	0	1	0	↑																																																																				
~																																																																												
P62	1	1	1	1	1	0																																																																						
P63	1	1	1	1	1	1	↑																																																																					
Position command 2	POS2	0x14																																																																										
Position command 3	POS3	0x15																																																																										
Position command 4	POS4	0x1A																																																																										
Position command 5	POS5	0x1B																																																																										
Position command 6	POS6	0x1C																																																																										
Position command trigger	CTRG	0x16	In position control with inner 8 registers(Pr mode), the combination of POS1/POS2/POS3 gives you a choice of 8 position commands when the CTRG is activated.	Pr																																																																								
Limit of forward rotation	LSP	0x18	Short circuit LSP and SG to make the forward rotation command valid.	Pt, Pr, S																																																																								
Limit of reverse rotation	LSN	0x19	Short circuit LSP and SG to make the forward rotation command valid.	Pt, Pr, S																																																																								
Inhibit pulse input	INHP	0x1D	Short circuit INHP and SG to make the external position pulse command invalid.	Pt																																																																								
Event trigger Pr command 1	EV1	0x1E	<p>There are 4 events with rising or falling edges can be set to trigger a specific PR command.</p> <p>EV□: Trigger the command by changing the DI status. □=1, 2, 3, 4</p> <p>PF83: Event Rising-edge Trigger Command (OFF → ON) PF84: Event Falling-edge Trigger Command (ON → OFF)</p> <p>Suitable case: sensor, preset trigger procedure</p>	Pr																																																																								
Event trigger Pr command 2	EV2	0x1F																																																																										
Event trigger Pr command 3	EV3	0x20																																																																										
Event trigger Pr command 4	EV4	0x21																																																																										

Absolute system communication I/O enable (Delta PLC )	ABSE	0x22	When ABSE is activated, it can initialize an absolute system and enable ABSQ, ABSR, ABSC, and ABSD as well. No matter what the original functions of DI4, DO2, and DO3 are, they will change to the function of ABSQ, ABSR, and ABSD respectively. ABSC can be assigned via the DI parameter setting.	ALL
Absolute system communication I/O enable (Mitsubishi PLC )	ABSM	0x22	When ABSM is activated, it can initialize an absolute system and enable ABSR, ABST, ABSB0, ABSB1 and ABSC. No matter what the original functions of DI4, DO2, DO3, and DO4 are, they will be switched to the function of ABSR, ABST, ABSB0, and ABSB1 respectively. The ABSC can be set via the DI parameter setting.	ALL
Absolute system origin setting	ABSC	0x23	When ABSC is activated, the pulse number of absolute encoder will be reset to zero. ABSC is effective only when ABSE or ABSM is valid and ON.	ALL
Pr mode stop command	STOP	0x24	To stop the motor running when STOP is activated.	ALL
Turret mode input 1	MD1	0x28	Mode switch option 1	Pr
Turret mode input 1	MD2	0x29	Mode switch option 2	Pr
Turret mode input 1	MD3	0x29	Mode switch option 3	Pr
Manual recurring	MPD1	0x2A	Recursion running command of turret operation	Pr
Manual stepping	MPD2	0x2B	Step running command of turret operation	Pr
Second speed option	SPS	0x2C	Speed option 2 of turret operation	Pr

### 3.3.6. CN1 DO signals

Every DO pin is programmable. There are 14 output functions could be assigned to the particular DO pin by the modification of parameter PD10 to PD14, PD26. The value from 0x01 to 0x0E is defined as the function described below.

Signal function	Sign	Value	Functions/Applications description	Control mode
Ready	RD	0x01	It is on as power is turned on and drive is ready to operate.	ALL
Alarm signal output	ALM	0x02	ALM-SG is isolated as power off or protection activated to cut off the main circuit. Without alarm occurring, ALM-SG would turn on after power on 1 second latter.	ALL
In-position ready	INP	0x03	INP turns on when the number of droop pulses is in the preset in-position range. The in-position range could be change using parameter PA12. When the in-position range is increased, INP may be kept conductive during low-speed rotation.	Pt, Pr
Speed attained	SA		SA turns on when the speed has nearly reached the preset command. When the preset command is 50r/min or less, SA always turns on.	S
Home moving completion	HOME	0x04	It turns on after the completion of home moving.	Pr
Torque limiting control	TLC	0x05	TLC-SG is on as motor generated torque reaches inner torque limit or torque analog limit. TLC-SG is off when SON signal is turned off.	Pt, Pr, S
Speed limiting control	VLC		In torque mode, VLC-SG is on as motor speed reaches inner speed limit or speed analog limit. VLC-SG is off when SON signal is turned off.	T
Electromagnetic brake interlock	MBR	0x06	When using this signal, make it usable by setting parameter PA01 as $\square 1 \square \square$ . MBR is off as the power is turned off or any alarm occurred.	ALL
Warning	WNG	0x07	WNG-SG is conductive as any warning occurred. Without warning occurring, WNG-SG is isolated.	ALL
Zero speed detection	ZSP	0x08	When the speed is under the preset of zero speed(50r/min), ZSP-SG keeps conductive. The zero speed range could be changed by PC17.	ALL
Pr command completion output	CMDOK	0x09	CMDOK-SG is conductive as the inner position command is completed or stopped.	Pr

Overload output warning	OLW	0x0A	OLW is activated when the servo drive has detected that the motor has reached the output overload level.	Pr
Motion control completed	MC_OK	0x0B	MC_OK is activated when CMDOK and INP are both ON. If only CMDOK or INP is ON, MC_OK will not be activated.	Pr
Pr command overflow	OVF	0x0C	OVF is activated when the servo drive has detected that an inner position command overflows.	Pr
Software positive limit	SWPL	0x0D	SWPL is activated when motor feedback pulses have reached the software positive limit.	Pr
Software negative limit	SWNL	0x0E	SWNL is activated when motor feedback pulses have reached the software negative limit.	Pr
Absolute system warning	ABSW	0x0F	The fault messages regarding the absolute encoder will be output via ABSW. (Delta PLC format compatible)	ALL
Absolute system data vanished	ABSV	0x10	The position lost causes this DO activated when the Mitsubishi ABS system is performed.	ALL
Positioning completion output 1	POS1	0x11	Positioning completion output 1 of turret operation	Pr
Positioning completion output 2	POS2	0x12	Positioning completion output 2 of turret operation	Pr
Positioning completion output 3	POS3	0x13	Positioning completion output 3 of turret operation	Pr
Positioning completion output 4	POS4	0x14	Positioning completion output 4 of turret operation	Pr
Positioning completion output 5	POS5	0x15	Positioning completion output 5 of turret operation	Pr
Positioning completion output 6	POS6	0x16	Positioning completion output 6 of turret operation	Pr

The DI default function of the CN1 changes depending on the control mode.

Value	Sign	Function	Pt	Pr	S	T	Pt-S	Pt-T	Pr-S	Pr-T	S-T
0x01	SON	Servo ON	DI1	DI1	DI1	DI1	DI1	DI1	DI1	DI1	DI1
0x02	RES	Reset	DI5	DI5	DI5	DI5	DI5	DI5	DI5	DI5	DI5
0x03	PC	Proportion control	DI3								
0x04	TL	Torque limit option	DI4		DI11	DI11	DI11	DI11			DI11
0x05	TL1	Inner torque limit option	DI11								
0x06	SP1	Speed option 1			DI6	DI6	DI2	DI2	DI11	DI11	DI6
0x07	SP2	Speed option 2			DI2	DI2					DI2
0x08	SP3	Speed option 3									
0x09	ST1	Forward rotation activated			DI3		DI3		DI3		
0x0A	ST2	Reverse rotation activated			DI4		DI4		DI6		
0x0A	RS1	Forward rotation option				DI4		DI4		DI6	DI4
0x09	RS2	Reverse rotation option				DI3		DI3		DI3	DI3
0x0B	ORGP	Origin positioned									
0x0C	SHOM	Start Home moving									
0x0D	CM1	Electronic gear option 1	DI2								
0x0E	CM2	Electronic gear option 2									
0x0F	CR	Clear	DI6	DI6			DI6	DI6			
0x10	CDP	Gain switch option	DI12		DI12	DI12	DI12	DI12			DI12
0x11	LOP	Control mode switch	DI8		DI8	DI8	DI8	DI8	DI8	DI8	DI8
0x12	EMG	External emergency stop	DI7	DI7	DI7	DI7	DI7	DI7	DI7	DI7	DI7
0x13	POS1	Position command 1		DI2					DI2	DI2	
0x14	POS2	Position command 2		DI3					DI12	DI12	
0x15	POS3	Position command 3		DI8							
0x16	CTRG	Position command trigger		DI4					DI4	DI4	
0x18	LSP	Limit of forward rotation	DI9	DI9	DI9	DI9	DI9	DI9	DI9	DI9	DI9
0x19	LSN	Limit of reverse rotation	DI10	DI10	DI10	DI10	DI10	DI10	DI10	DI10	DI10
0x1A	POS4	Position command 4		DI11							
0x1B	POS5	Position command 5		DI12							
0x1C	POS6	Position command 6									



0x1D	INHP	Inhabit pulse input										
0x1E	EV1	Event trigger Pr command 1										
0x1F	EV2	Event trigger Pr command 2										
0x20	EV3	Event trigger Pr command 3										
0x21	EV4	Event trigger Pr command 4										
0x22	ABSE	Absolute system I/O enable										
0x22	ABSM	Absolute system I/O enable										
0x23	ABSC	Absolute system origin setting										
0x24	STOP	Pr mode stop command										

The DO default function of the CN1 changes depending on the control mode.

Value	Sign	Function	Pt	Pr	S	T	Pt-S	Pt-T	Pr-S	Pr-T	S-T
0x01	RD	Ready	DO5	DO5	DO5	DO5	DO5	DO5	DO5	DO5	DO5
0x02	ALM	Alarm signal output	DO6	DO6	DO6	DO6	DO6	DO6	DO6	DO6	DO6
0x03	INP	In-position ready	DO1	DO1			DO1	DO1	DO1	DO1	
0x03	SA	Speed attained			DO1		DO1		DO1		DO1
0x04	HOME	Home moving completion									
0x05	TLC	Torque limiting control	DO4	DO4	DO4		DO4	DO4	DO4	DO4	DO4
0x05	VLC	Speed limiting control				DO4		DO4		DO4	DO4
0x06	MBR	Electromagnetic brake interlock			DO3	DO3					DO3
0x07	WNG	Warning	DO3			DO1	DO3	DO3			
0x08	ZSP	Zero speed detection	DO2	DO2	DO2	DO2	DO2	DO2	DO2	DO2	DO2
0x09	CDMOK	Pr command completion output		DO3					DO3	DO3	
0x0A	OLW	Overload output warning									
0x0B	MC_OK	Motion control completed									
0x0C	OVF	Pr command overflow									
0x0D	SWPL	Software positive limit									
0x0E	SWNL	Software negative limit									
0x0F	ABSW	Absolute system warning									
0x10	ABSV	ABS data vanished									

### 3.3.7. Interface wiring diagram

#### (1). DI of sink mode

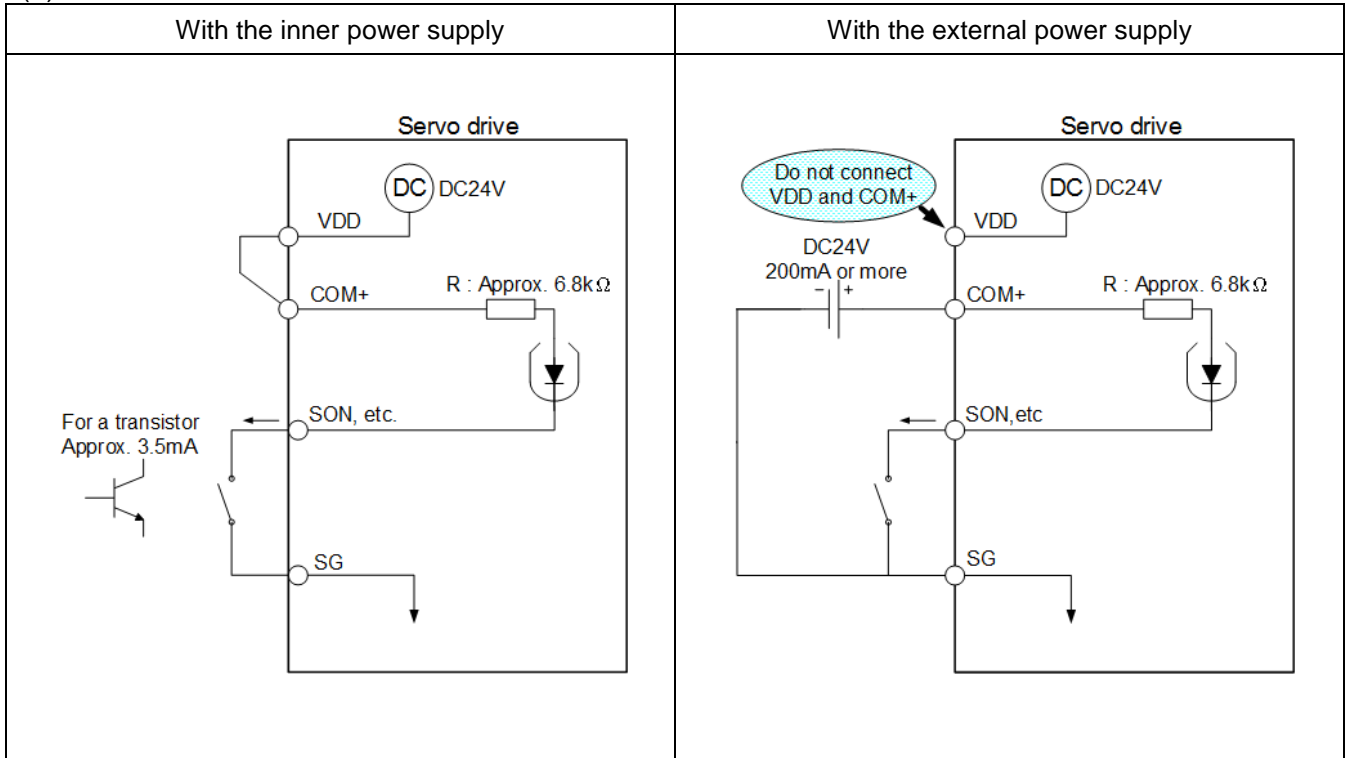

#### (2). DI of source mode

When using the input interface of source type, all DI input signals are of source type. Source output could not be provided.

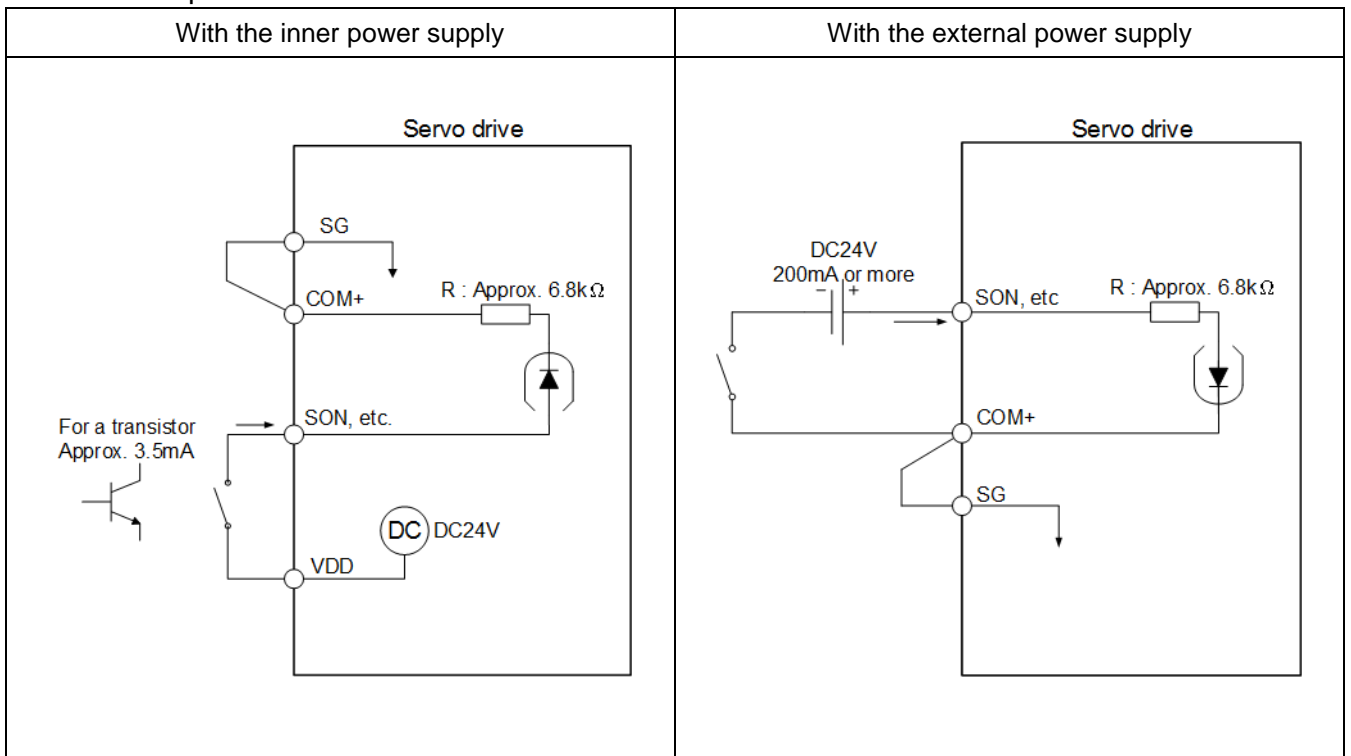

(3). DO interface

Lamp, relay or photo coupler could be driven. A diode for relay load, or a suppressing resistor for lamp load is necessary. (Permissible current: 40mA or less, inrush current: 100mA or less)

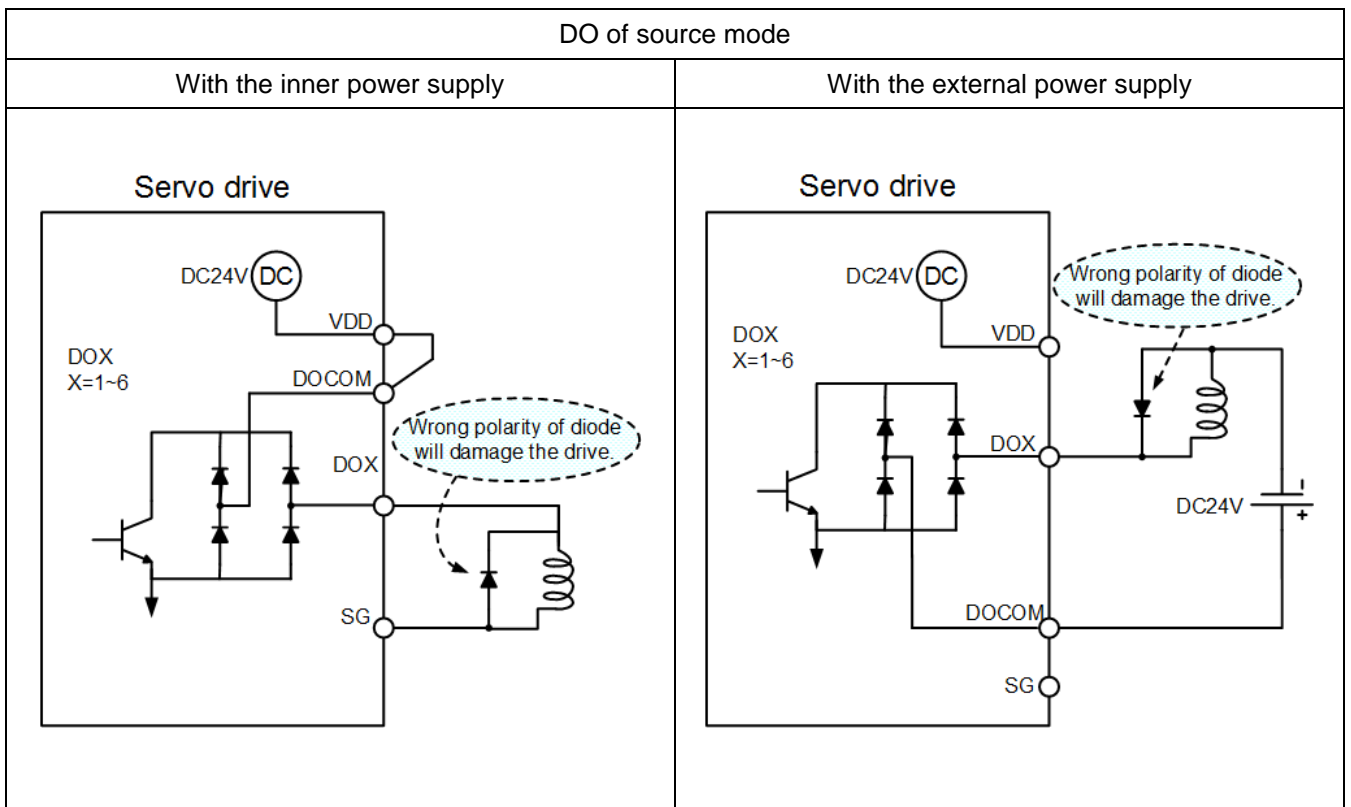
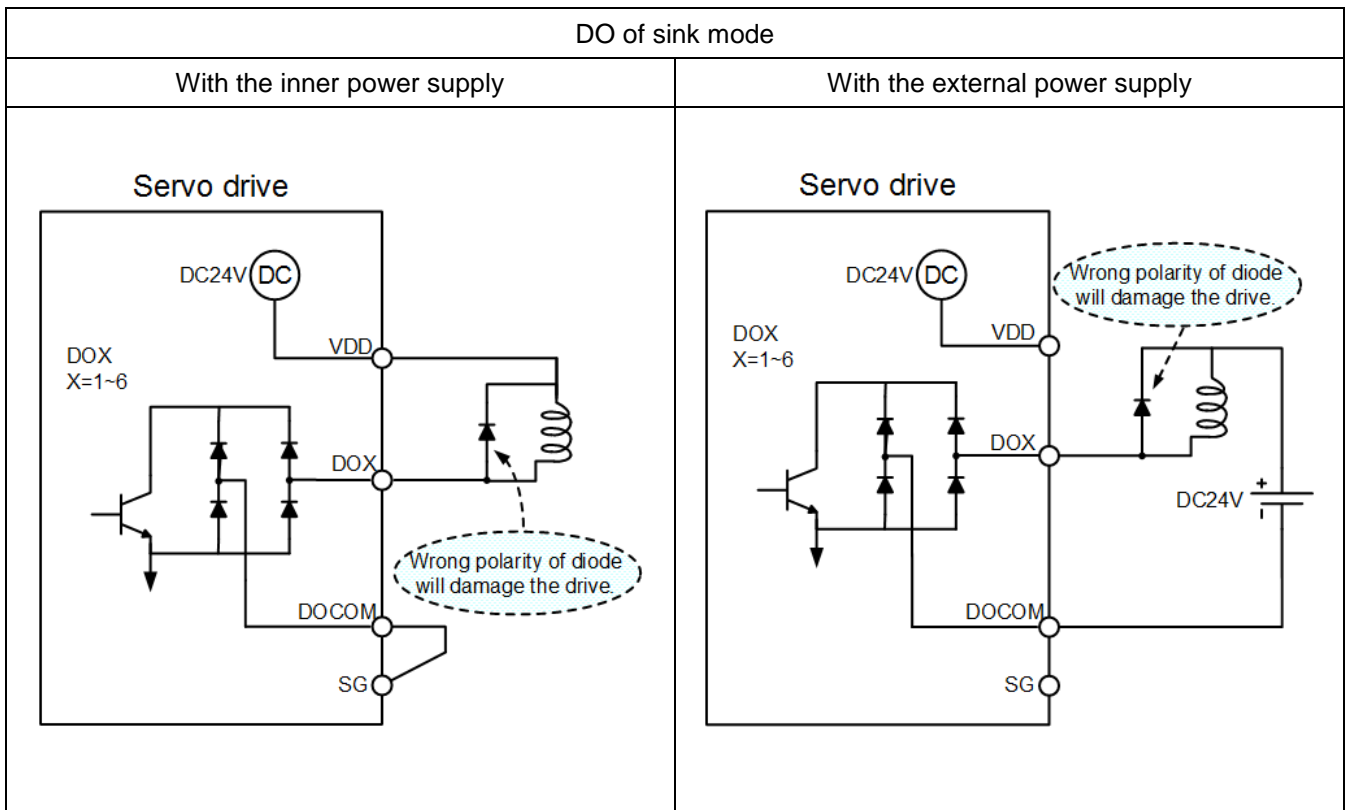

(4). Speed analog command, torque analog command and MON1, MON2 analog output.  
 Input impedance 10KΩ to 12KΩ / Output voltage ±10V.

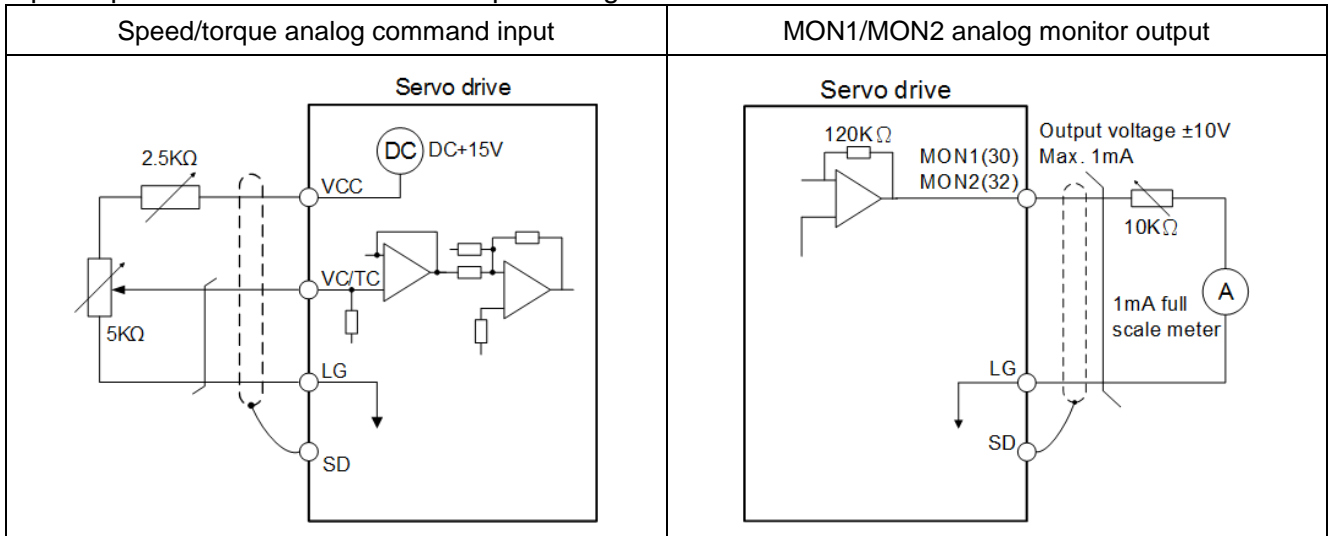

(5). Encoder pulse output

Output a pulse train signal in the open collector or differential type. Open collector output could be obtained via the pin 39(OP) of CN1. The maximum output current is 35mA.

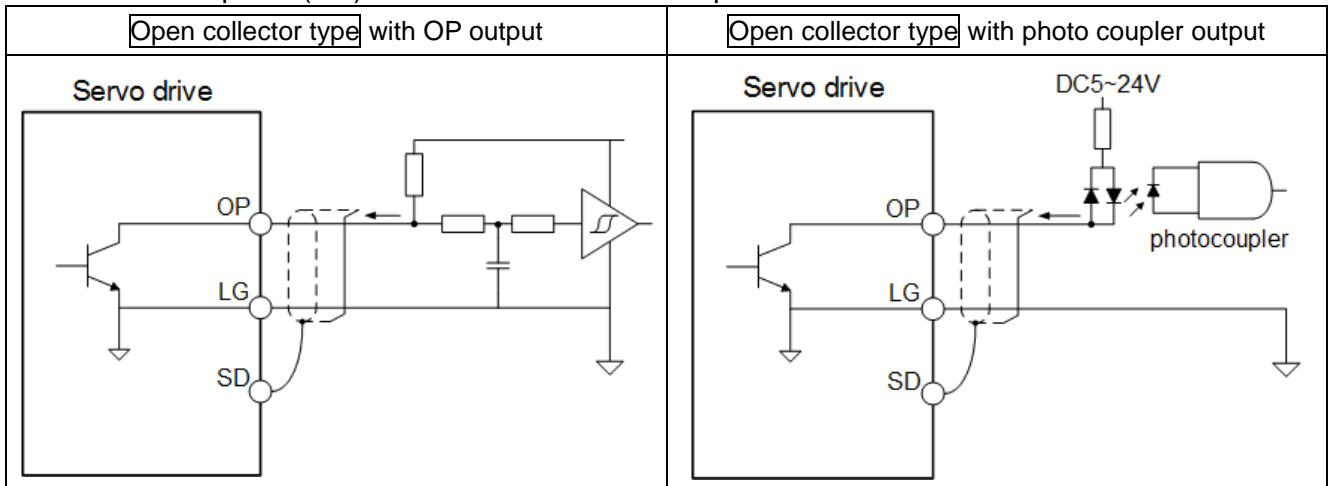

For a differential line drive system, the maximum output current is 20mA.

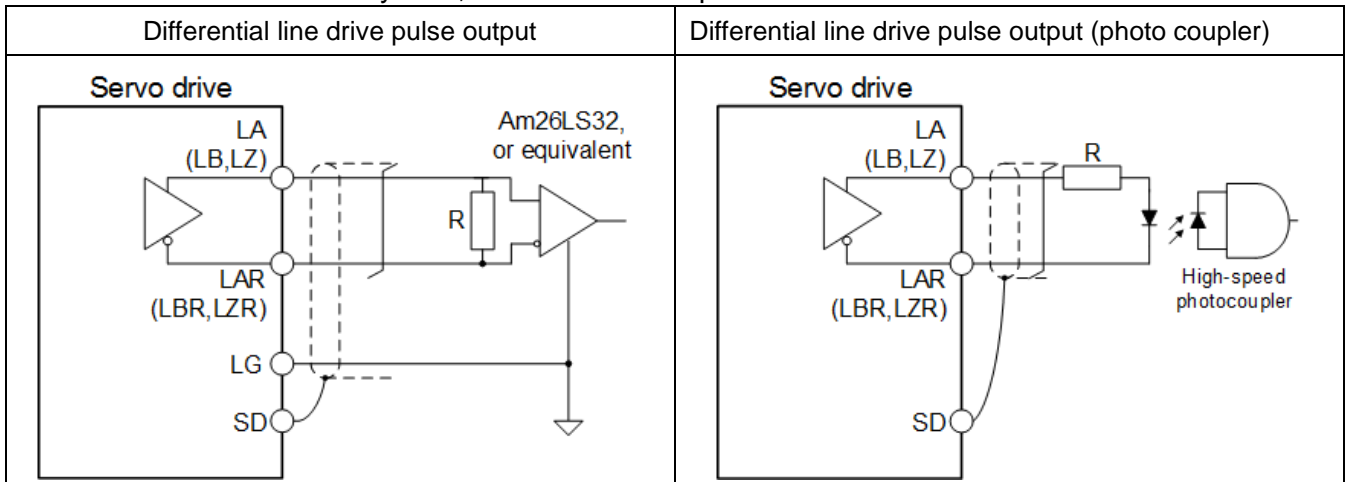

(6). Forward/reverse rotation pulse train input

Input a pulse train signal in open collector or differential line drive type. The maximum input pulse frequency is 4Mpps for differential line drive and 200kpps for open collector type.

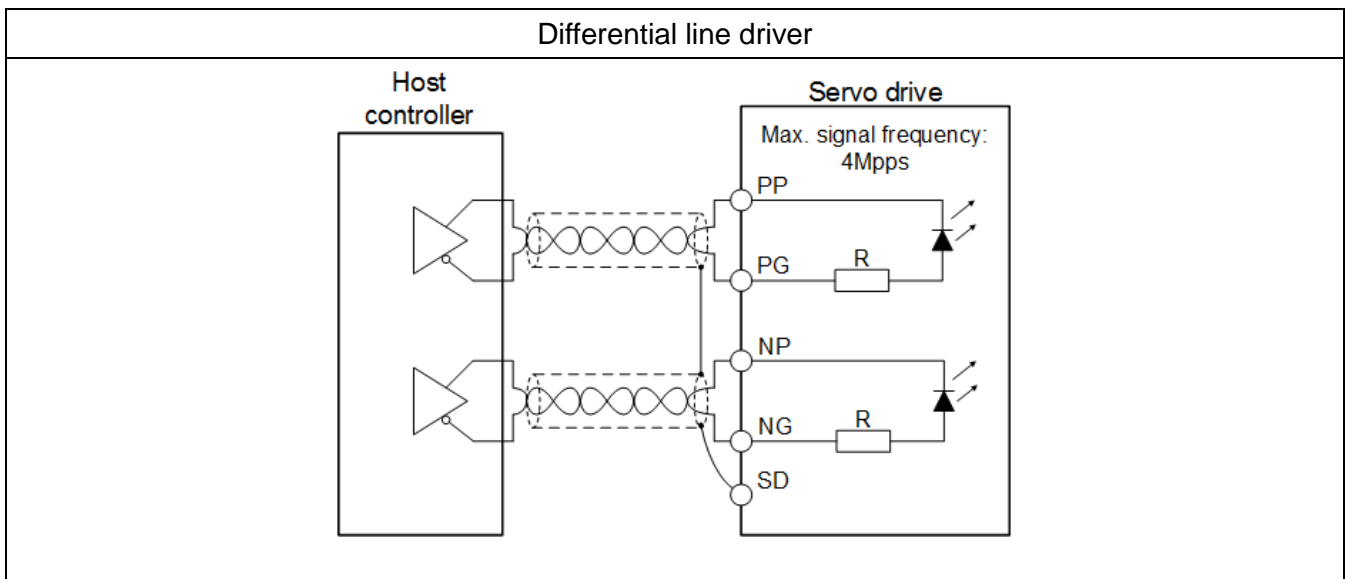
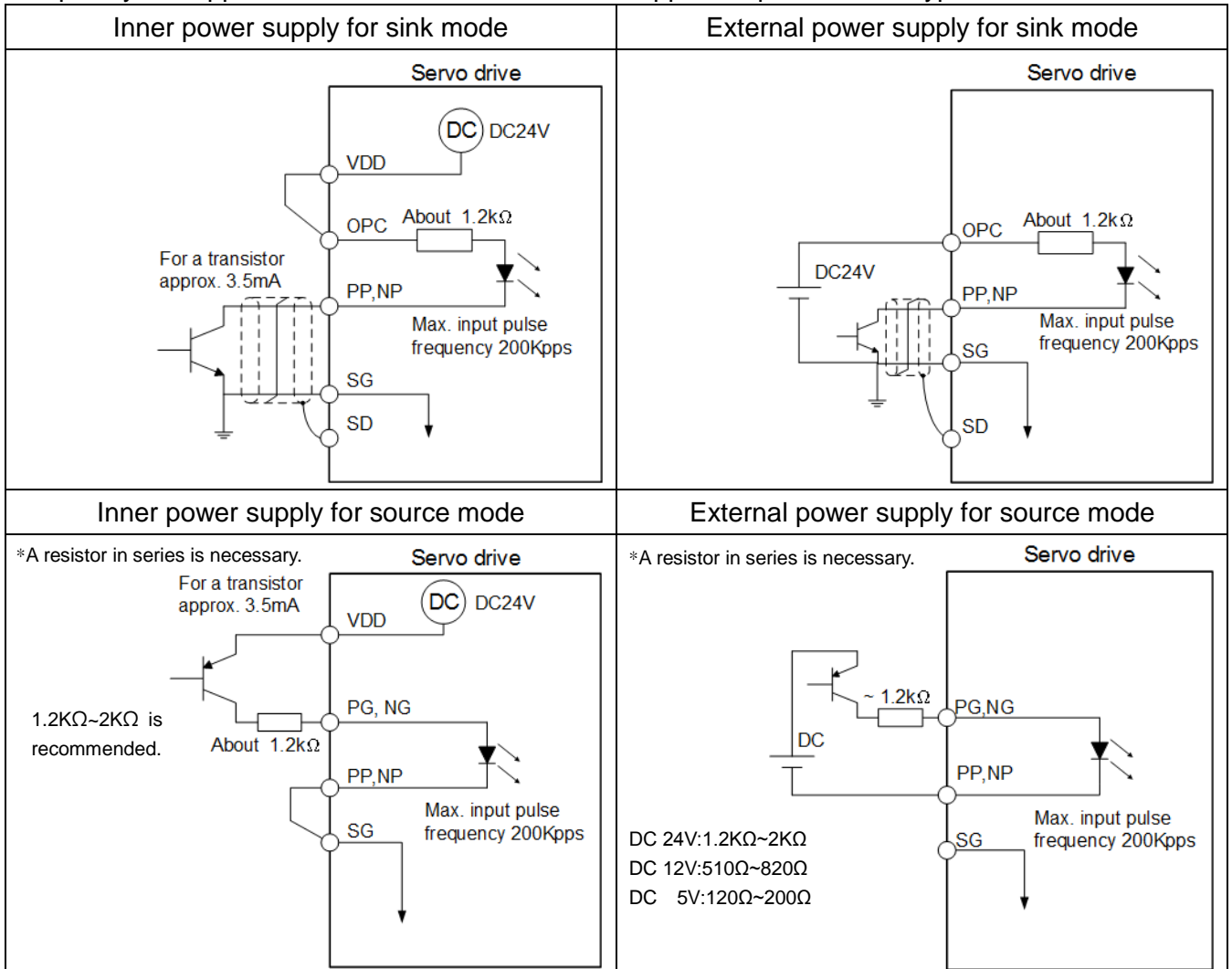

### 3.4. CN2 Encoder signal wiring and description

The encoder resolution of SME servo motor is 22-bit per revolution. The appearance of CN2 connector is shown below.

**Drive side**

CN2 front view (This is a connector of 3M.)

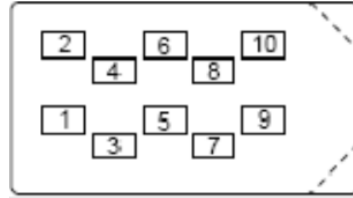

CN2 compatible connector for the encoder cable



side view



rear view

**Cable side**

There are two connector types for the different capacity motors.

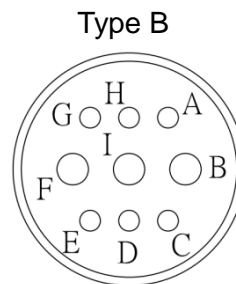
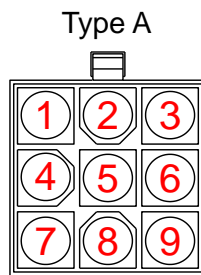

The pin names and descriptions are listed below:

CN2	Type A	Type B	Signal name	Sign	Function description
1	7	B	5V power	Vcc (5V)	+5V power supply for encoder
2	8	A	Ground	GND(3.6V)	DC 3.6V ground
3	-	-	5V power	Vcc (5V)	+5V power supply for encoder
4	4	F	Ground	GND(5V)	DC 5V ground
5	3	H	3.6V power	Vcc (3.6V)	+5V power supply for encoder
6	6	D	ENCP	ENCP	Serial communication signal ENCP
7	5	E	ENCN	ENCN	Serial communication signal ENC�
8	1	C	--	--	--
9	2	G	--	--	--
10	9	I	SHIELD	SHIELD	SHIELD

### 3.5. CN3 communication port signal wiring and description

CN3 port is for RS-485 communication. With the Shihlin servo communication software, users could perform the parameters setting, the motor status monitoring, the motor running and test, etc. The RS485 format provides a longer distance communication and multiple drives application.

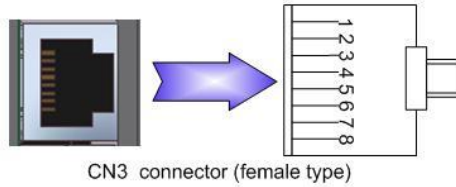

Pin NO	Sign	Function description
1~3	GND	Signal ground.
4	RS-485-A	Data are transmitted in differential line driver. Line driver A.
5	RS-485-A	Data are transmitted in differential line driver. Line driver B.
6~8	GND	Signal ground.

For RS-485 communication, please refer to section 9.1

### 3.6. CN4 USB communication port

CN4 port is for USB communication. With the Shihlin servo communication software, users could connect it to the computer then set parameters, monitor the status, operate and test, etc. CN4 is a Mini-USB type.

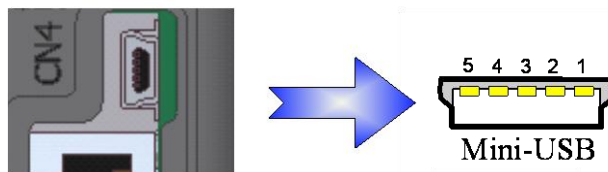

The following table describes the pin assignment of CN4.

Pin No.	Function description
1	+5V
2	D-
3	D+
4	NC
5	GND

### 3.7. CN5 battery power socket

When the absolute encoder servo motor is performed, the backup power for absolute encoder is necessary. The SDE servo drive provides a socket which the power wires of battery box could plug in.

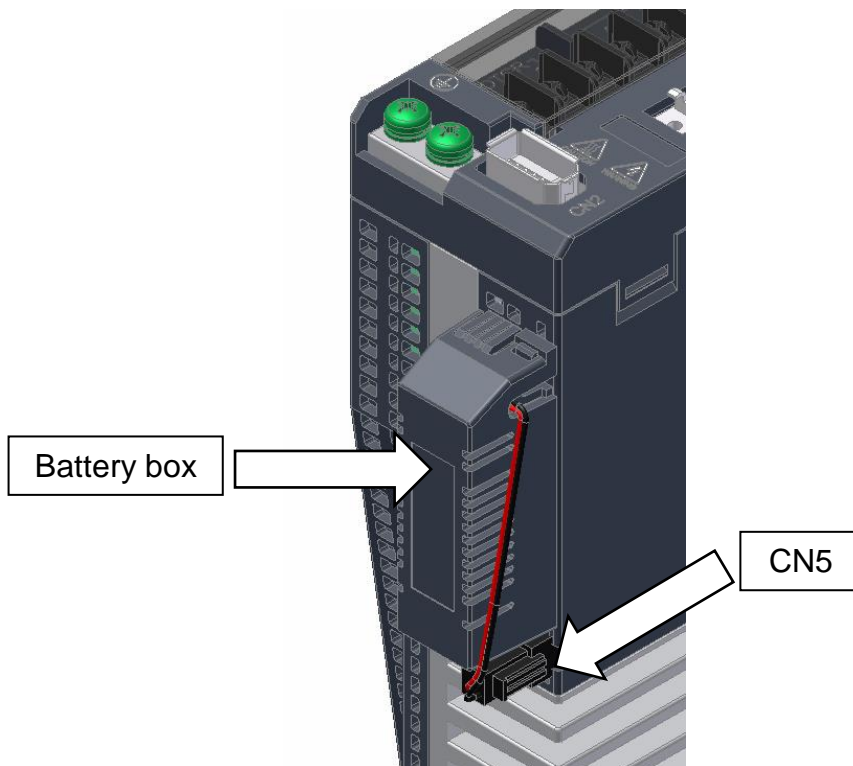

The following table describes the pin assignment of CN5.

Pin NO	Sign	Function description
1	Vcc(3.6V)	The battery power voltage is 3.6 volt.
2	GND	The battery power ground.



### 3.8. Standard wiring method



#### DANGER

- Any person who does the wiring job should be fully competent.
- Before wiring, turn off the power and wait for 10 minutes or more until the charge LED turns off. Otherwise, an electric shock may occur.
- Ground the servo drive and servo motor tightly.
- Not to wire the servo amplifier and servo motor until they have been installed. Otherwise, it may cause an electric shock.
- The cable should not be damaged, stressed, loaded, or pinched. Otherwise, it may cause an electric shock.



#### CAUTION

- The wires between the servo drive and servo motor should be correctly. Otherwise, the servo motor may run unexpectedly.
- The wirings of cables and terminals should be correct, otherwise a burst, malfunction, etc. may occur.
- Ensure that polarity (+/-) is correct. Otherwise, a burst, malfunction, etc. may occur.
- The surge absorbing diode installed to the DC relay for output control should be proper in the specified direction. servo motor can not be connected to the commercial power directly. Otherwise, the emergency stop and other protective circuits may not work.
- The electronic equipment around the servo drive may be interfered, please use the EMI suppression filter to improve.
- Not to connect a power factor capacitor, surge absorber or radio noise filter with the power line of the servo motor.
- When using a regenerative resistor, switch power off by AL04 signal. Otherwise, a brake IGBT fault may cause a fire due to overheated the regenerative resistor.
- Do not modify the servo drive or servo motor.

### 3.8.1. Wiring diagram of position control(Pr Mode)

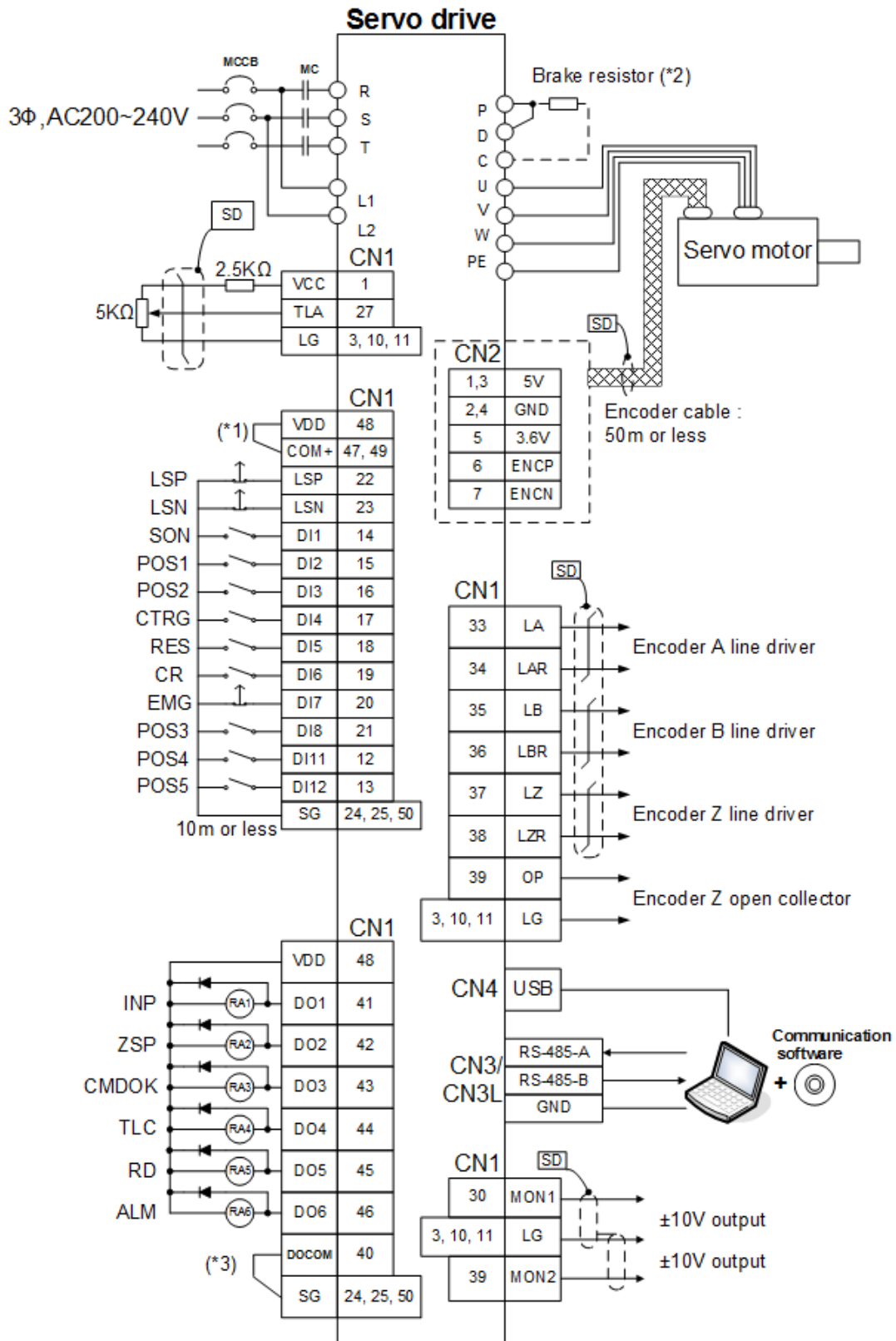

- ◆ Note: 1. If the external power is applied, do not connect VDD and COM+.
- 2. See section 3.1 for the wirings of brake resistor.
- 3. See section 3.3.6 for DO sink or source wiring.

### 3.8.2. Wiring diagram of position control(Pt Mode)

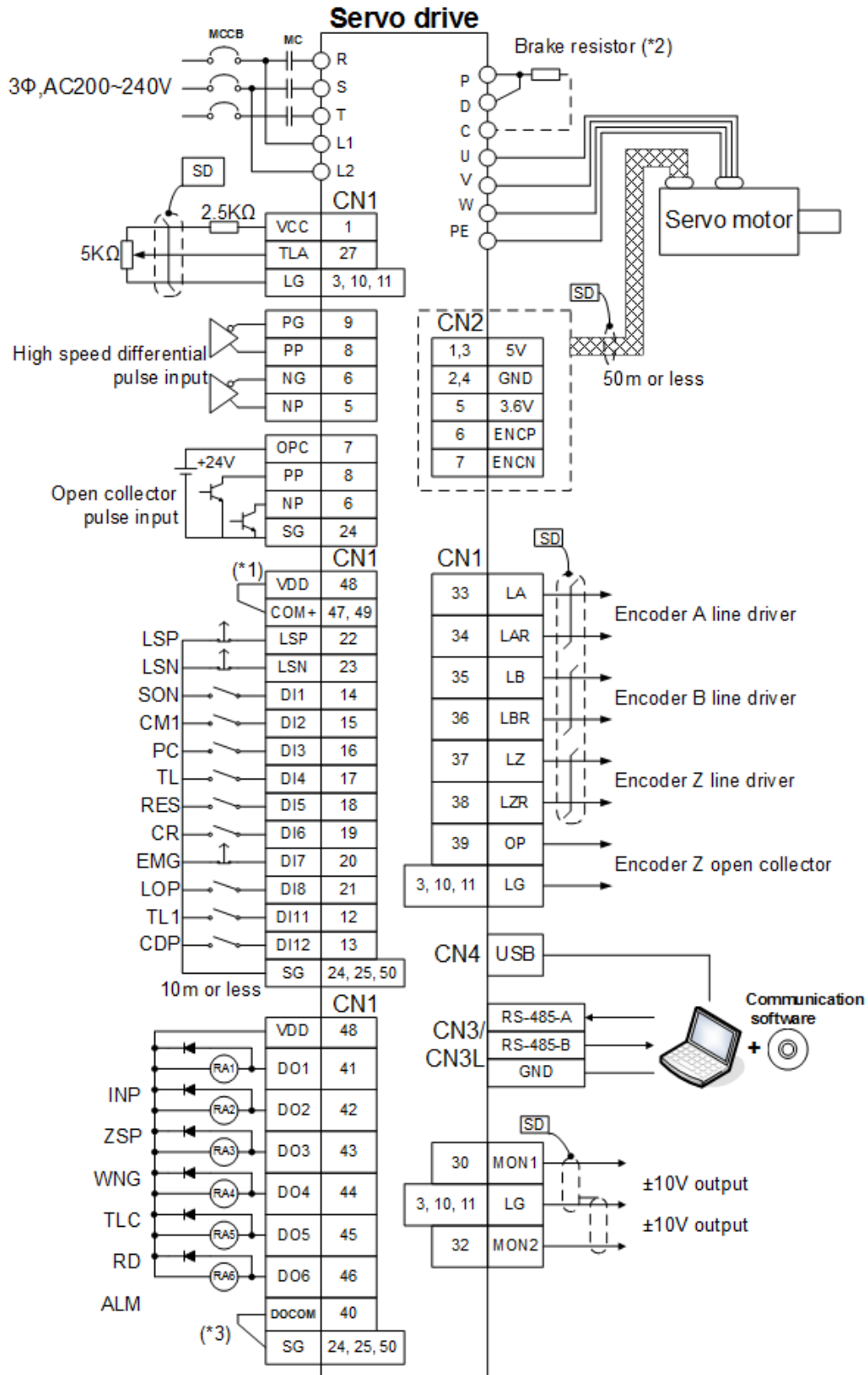

- ◆ Note: 1. If the external power is applied, do not connect VDD and COM+.
- 2. See section 3.1 for the wirings of brake resistor.
- 3. See section 3.3.6 for DO sink or source wiring.

### 3.8.3. Wiring diagram of speed control(S Mode)

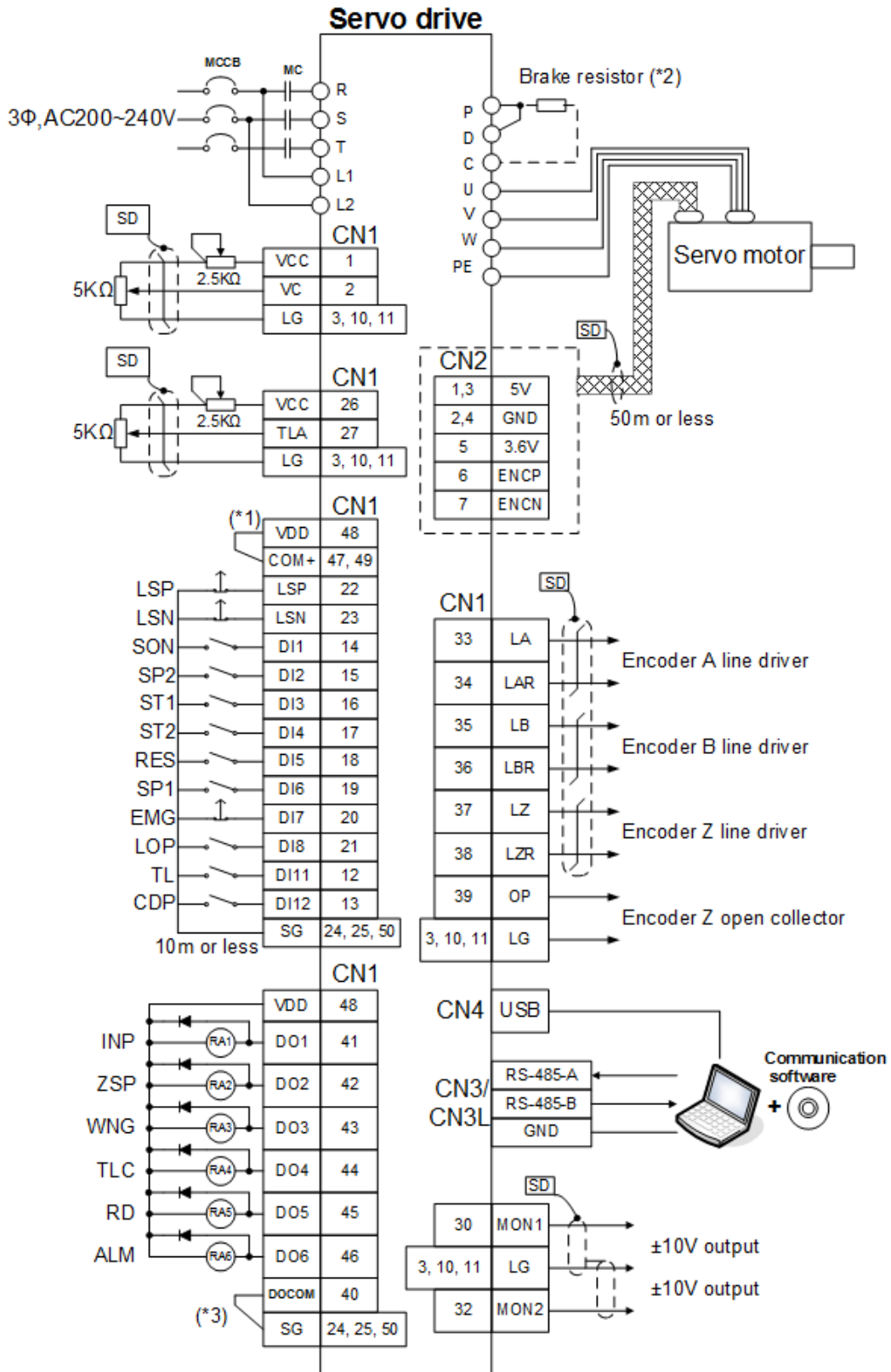

- ◆ Note: 1. If the external power is applied, do not connect VDD and COM+.
- 2. See section 3.1 for the wirings of brake resistor.
- 3. See section 3.3.6 for DO sink or source wiring.

### 3.8.4. Wiring diagram of torque control(T Mode)

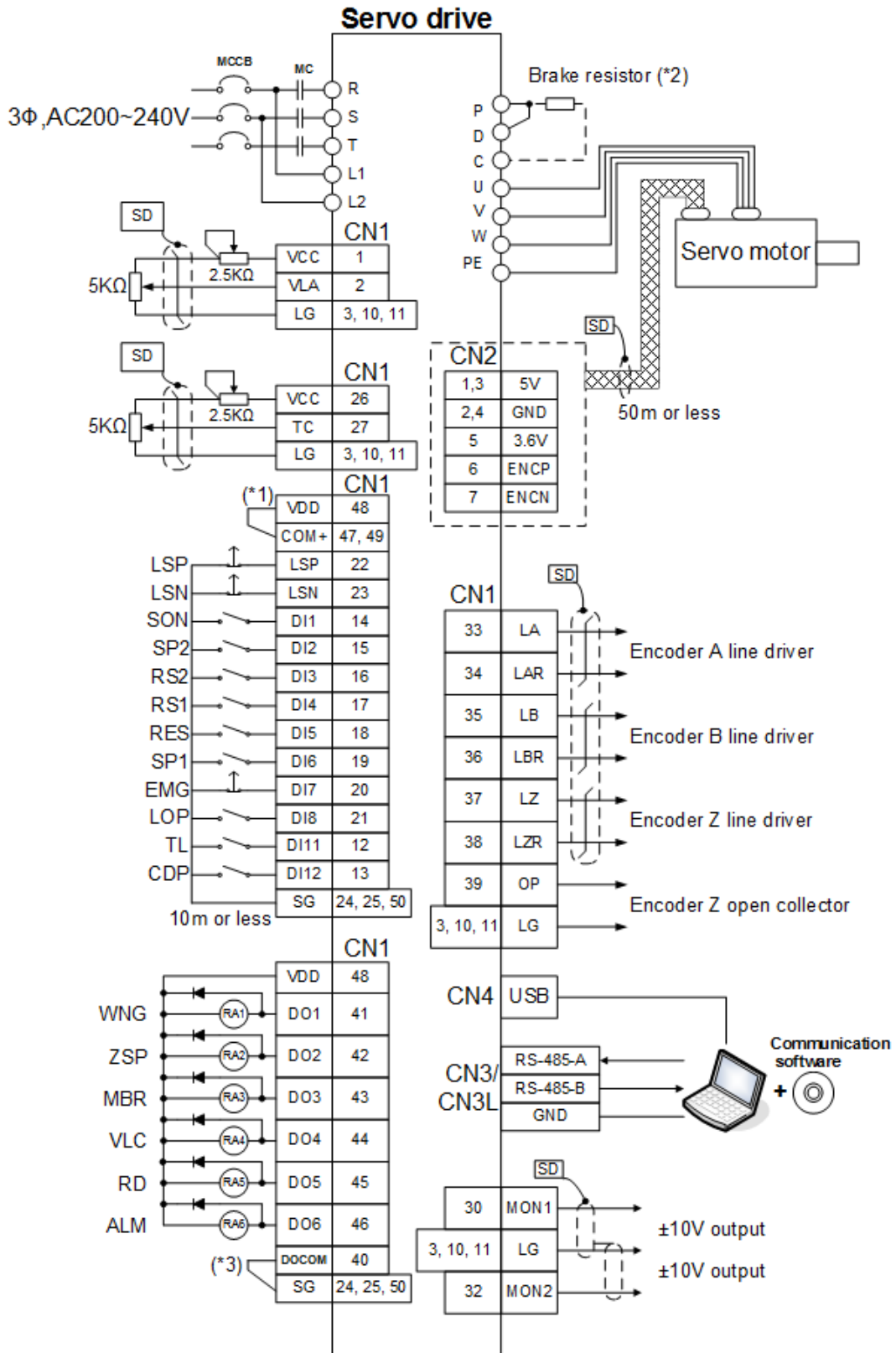

- ◆ Note: 1. If the external power is applied, do not connect VDD and COM+.
- 2. See section 3.1 for the wirings of brake resistor.
- 3. See section 3.3.6 for DO sink or source wiring.

## 4. Startup

**⚠ DANGER** ● Do not operate the switches with wet hands. Otherwise, it may cause an electric shock.

**⚠ CAUTION** ● Before running the servo motor, check the parameters. Any improper settings may cause machines some unexpected operation.  
● The servo drive heat sink, regenerative resistor, servo motor, etc. may be hot while power is on or for an interval after power off. Not to touch them mentioned above to avoid burns.

### 4.1. Switching power on for the first time

When switching power on for the first time, follow the instructions below to make a startup.

#### 4.1.1. Startup procedure

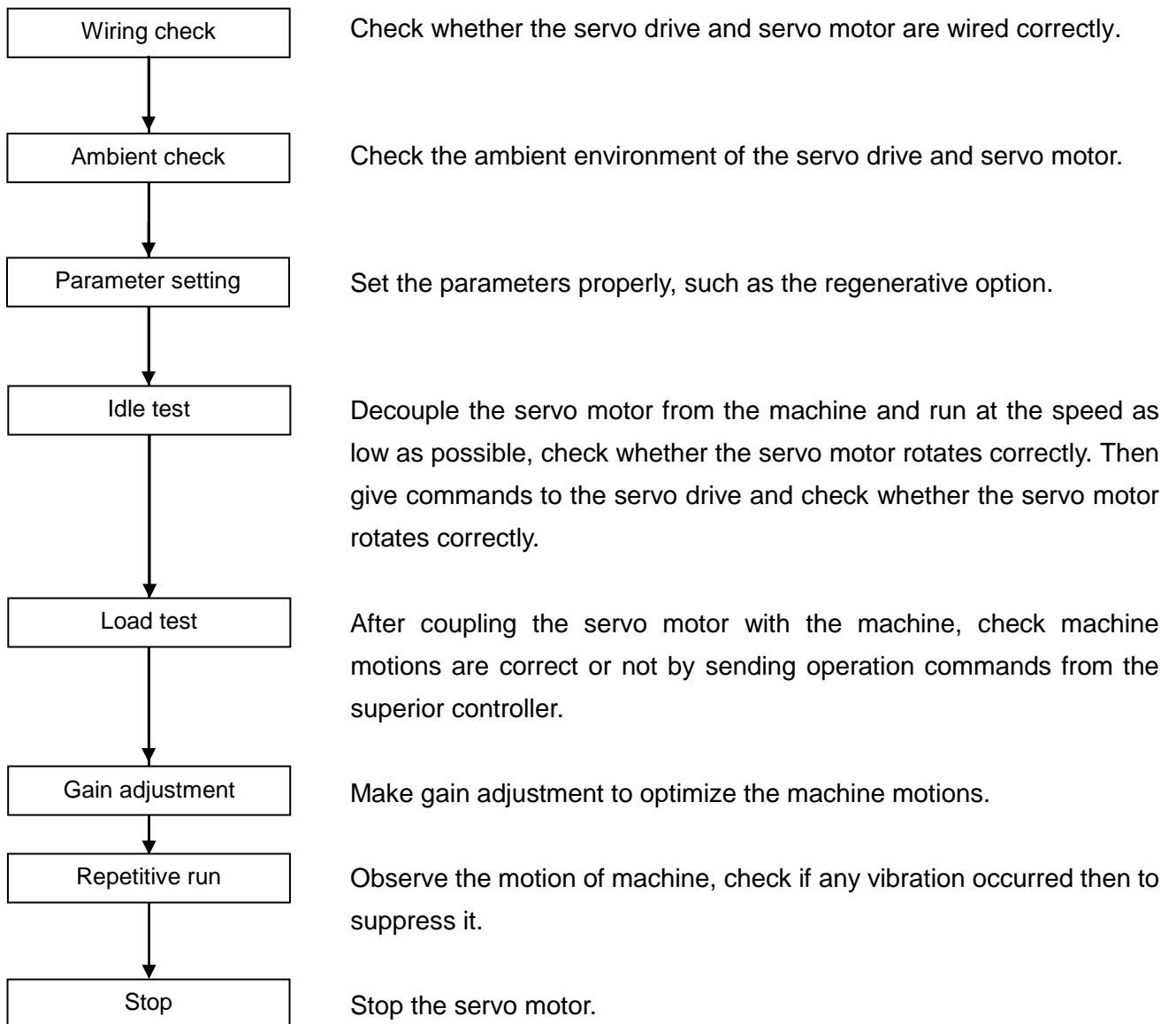

## 4.1.2. Wiring check

### (1) Power supply system wiring

Before switching on the power supply, check the following items.

#### (a) Power supply system wiring

The power supplied to the power input terminals (R, S, and T) of the servo drive should satisfy the defined specifications.

#### (b) Connection of servo drive and servo motor

1) The servo drive power output (U, V, and W) should match in phase with the servo motor power input terminals (U, V, and W).

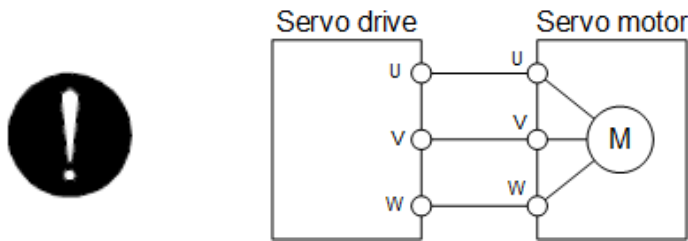

2) The power supplied to the servo drive should not be connected to the power outputs (U, V, and W). Otherwise, this will damage the servo drive and servo motor.

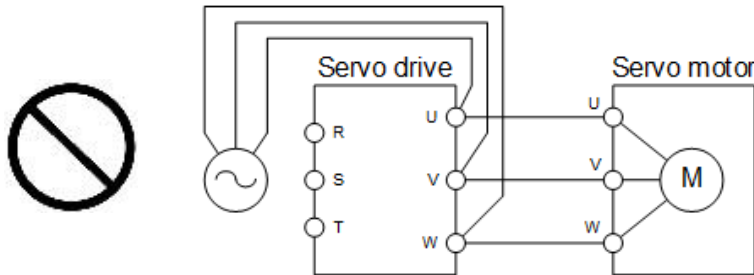

3) The grounding terminal of the servo motor should be connected to the PE terminal of the servo drive.

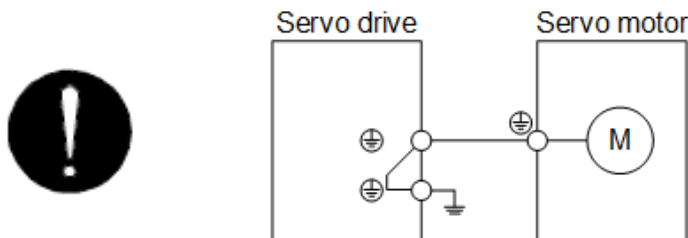

(c) When you use a regenerative option, the built-in regenerative resistor and wirings should be removed from the servo drive, the lead wire of built-in regenerative resistor connected to P+ terminal and C terminal should not be connected. The regenerative option should be connected to P+ terminal and C terminal.

## (2) I/O signal wiring

- (a) The I/O signals should be connected correctly.

Use DO forced output to forcibly turn on/off the pins of the CN1 connector. This function can be used to perform a wiring check. Switch off SON (Servo-on) to enable the function.

Refer to section 3.2 for details of I/O signal connection.

- (b) A voltage exceeding DC 24 V is not applied to the pins of the CN1 connector.
- (c) Not to short SD and DOCOM of the CN1 connector together.

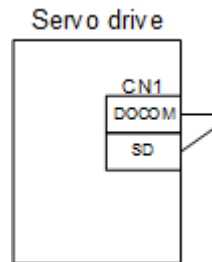

## 4.1.3. Ambient environment

### (1) Cable routing

- (a) The wiring cables should not be stressed.
- (b) The encoder cable should not be used in excess of its bending life.
- (c) The connector of the servo motor should not be stressed.

### (2) Environment

Signal cables and power cables are not shorted by metallic dust or the like.



## 4.2. Display and operation

The SDE servo drive equips a 5-digit, 7-segment LED display and 4 pushbuttons for servo drive status display, alarm display, parameter setting, etc. The operation and display are described below.

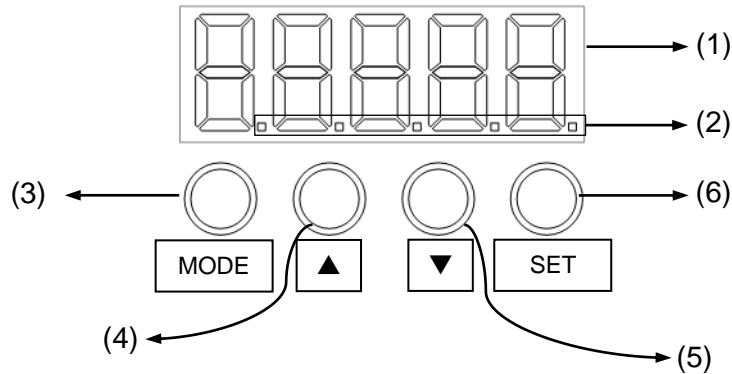









No	Name	Function description
(1)	5-digit, 7-segment LED	To display motor status, parameters, and abnormal messages.
(2)	Decimal LED	To displays the decimal points, negative value, etc.
(3)	MODE key	Display mode change, low/high switching.
(4)	UP Key	This key is used to scroll up the display or data.
(5)	DOWN key	This key is used to scroll down the display or data.
(6)	SET key	To show or save the value which is operated.

The following table lists the display examples.

Item	Status	5-digit, 7-segment LED
Motor rotation speed	Reverse rotation at 3000r/min	-3000
Load to motor inertia ratio	15.5 times	15.5
Motor feedback revolution	-12345 turns	12.345 To light the 5 decimal points.
parameter setting accomplished	a successful EEPROM write-in	-End-
parameter setting failed	a failed EEPROM write-in	Error

### 4.3. Display flowchart

Press “MODE” key once to shift to the next display mode. Refer to section 4.4 and later for related display. To read or set the extension parameters, make them valid with the PA42 setting.

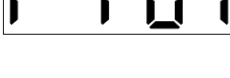
Display process	Initial Screen	Function description	Reference
Status		Servo status display. This message 「FbP」 appears at power-on.(*)	Section 4.4
Alarm		Display current alarm and history records.	Section 4.7
Diagnosis		Sequence display, external signal display, DO forced output, test operation, inertia estimation, VC automatic offset, software version display.	Section 4.5
Basic parameters		Display and setting of basic parameters.	Section 4.8
Gain/Filter parameters		Display and setting of Gain/Filter parameters.	
Speed/torque parameters		Display and setting of speed and torque mode parameters.	
I/O setting parameters		Display and setting of I/O related parameters.	
Pr related parameters		Pr mode related parameters group 1	
Pr related parameters		Pr mode related parameters group 2	

## 4.4. Status display

Press “MODE” key once to shift to the next display mode. Press the “UP” or “DOWN” key to change the display data as desired. When the required data is selected, the corresponding data appears. Press the “SET” key to display the information. A negative value which occupies 5 digits is displayed by the 5 lit decimal points. If a negative value which occupies only 4 digits or less, the negative symbol “-“ is displayed at the highest digit. The servo statuses which may be shown are listed in the following table:

Status display	Sign	unit	Description
Motor feedback pulses (High 5-digit)	FPH.I	pulse	Feedback pulses from the motor encoder are counted and displayed. Ex: A cumulated value of motor feedback pulses 123456789, FPHI=1234, FPLI=56789.
Motor feedback pulses (Low 5-digit)	FPL.I		
Command pulses (High 5-digit)	CPH.I	pulse	The external command pulses are counted and displayed. Ex: The number of droop pulses 123456789, CPHI=1234. CPLI=56789.
Command pulses (Low 5-digit)	CPL.I		
Accumulative pulses error (Low 5-digit)	E.I	pulse	The difference which only low 5-digit between command and motor feedback pulses are shown.
Translated motor feedback pulses (High 5-digit)	FPH.O	pulse	The motor feedback pulses are multiplied by the electronic gear then displayed.
Translated motor feedback pulses (Low 5-digit)	FPL.O		
Translated command pulses (High 5-digit)	CPH.O	pulse	The command pulses are re-counted by the electronic gear ratio then displayed.
Translated command pulses (Low 5-digit)	CPL.O		
Translated accumulative pulses error (Low 5-digit)	E.O	pulse	The difference which only low 5-digit between command and motor feedback pulses are multiplied by the electronic gear then are shown.
Command pulse frequency	CPF	kHz	The frequency of command pulses is counted and displayed.
Motor speed	r	rpm	The current speed of servo motor is displayed.
Analog speed command /limit voltage	F	V	Speed: It denotes the analog voltage of speed command. Torque: It denotes the analog voltage of speed limit.
Speed input command/limit	V	rpm	Speed: It denotes the speed command. Torque: It denotes the speed limit.







Status display	Sign	unit	Description
Analog Torque command /limit voltage	U	V	Position/Speed: It denotes the analog voltage of torque limit. Torque: It denotes the analog voltage of torque command.
Torque input command/limit	TC	%	Position/Speed: It denotes the rated torque limit percentage. Torque: It denotes the torque command percentage.
Effective load ratio	J	%	The continuous and effective load torque is displayed relative to the rated torque of 100%.
Peak load ratio	b	%	The highest value in the past 15 seconds is displayed relative to the rated torque of 100%.
DC bus voltage	Pn	V	The P-N voltage of main circuit is displayed. "Lo-dC" is shown if it is less than normal value.
Load to motor inertia ratio	dC	times	Load to motor inertia ratio is displayed.
Instantaneous torque	T	%	The Instantaneous torque value is displayed relative to the rated torque of 100%.
Regeneration load ratio	L	%	The permissible percentage of regenerated power is shown.
Pulses of Z phase reference acknowledged	ZP	pulse	The pulses of Z phase reference acknowledged are shown.

Changing the parameter PA01, the status item of the servo drive at power on could be changed. The item displayed in the initial status changes with the control mode as follows.

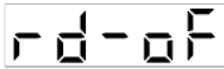
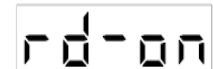
Control mode	Status display at power on
Position	Motor feedback pulses (Low 5-digit)
Position / speed	Motor feedback pulses(Low 5-digit) / Motor speed
Speed	Motor speed
Speed / (torque)	Motor speed /( Analog Torque command/limit voltage)
Torque	Analog Torque command/limit voltage
(Torque) / position	(Analog Torque command/limit voltage) / Motor feedback pulses(Low 5-digit)

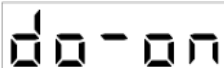
## 4.5. Diagnostic display

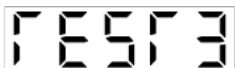
The following table provides information display related to the diagnostic mode.

Name		Display	Description
Control status			Not ready yet. The drive is being initialized, an alarm has occurred or the SON DI is not activated.
			Ready. Initialization completed; the drive is ready for operation.
External I/O signal display			Indicates the ON/OFF states of the external I/O signals. The upper segments correspond to the input signals and the lower ones to the output signals. The I/O signals could be changed by the modification of PD group parameters.
DO forced output			Digital output signals could be forced ON/OFF.
Test operation	JOG		JOG could be executed if there is no external command.
	Positioning		Positioning could be executed when there is no external command. The PC communication software via RS-485 or USB is required.
	Inertia estimation		This operation could be executed the estimation of load to motor inertia ratio or related gain values. This operation cannot be performed with the display panel.
Automatic offset of analog input			The offset voltages causes the motor to rotate slowly at the speed analog command 0V or speed analog limit 0V, this calibration makes a zero level adjustment. When using this function, the PC26 would automatically save the result. Please follow the steps to operate. <ol style="list-style-type: none"> <li>(1). Scroll to the diagnostic display.</li> <li>(2). Press the "SET" key once.</li> <li>(3). Press the "UP" or "DOWN" key and select 1.</li> <li>(4). Press the "SET" key.</li> </ol>
Software version(low)		SE-A0	Indicates the version of the software.
Software version(high)		100-0	Indicates the system number of the software.

The applications of diagnostic display are described as follows.

#### 4.5.1. Indication of external I/O signals

This display is used to verify the ON/OFF states of digital I/O signals connected to the drive.

##### (1) Operation

Call the display screen after power on. Press the “MODE” key to show the diagnostic screen:

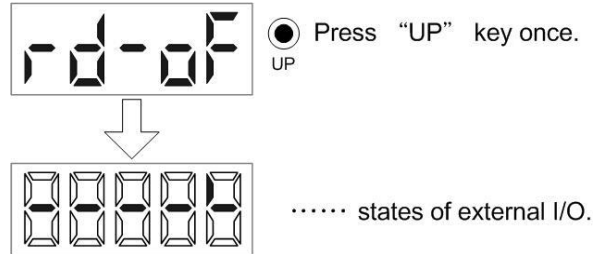

##### (2) Display of I/O pin definition

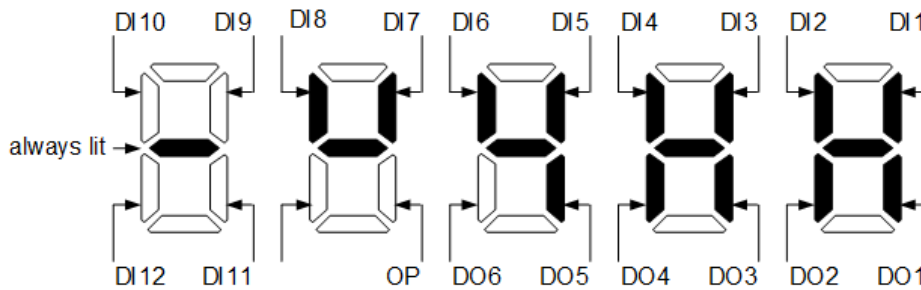

The figure above as an example: DI1 to DI8 are “ON” status. DI9 and DI10 are “OFF” status. DO1 to DO5 are “ON” status, DO5 and DO6 are “OFF” status.

Connector	Pin No.	Input/output	Pt	Pr	S	T
CN1	12	I	TL1	POS4	TL	TL
	13	I	CDP	POS5	CDP	CDP
	14	I	SON	SON	SON	SON
	15	I	CM1	POS1	SP2	SP2
	16	I	PC	POS2	ST1	RS2
	17	I	TL	CTRG	ST2	RS1
	18	I	RES	RES	RES	RES
	19	I	CR	CR	SP1	SP1
	20	I	EMG	EMG	EMG	EMG
	21	I	LOP	POS3	LOP	LOP
	22	I	LSP	LSP	LSP	LSP
	23	I	LSN	LSN	LSN	LSN
	41	O	INP	INP	SA	WNG
	42	O	ZSP	ZSP	ZSP	ZSP
	43	O	CMDOK	CMDOK	MBR	MBR
	44	O	TLC	TLC	TLC	VLC
	45	O	RD	RD	RD	RD
46	O	ALM	ALM	ALM	ALM	

#### 4.5.2. DO forced output

The output signals could be forced on/off and do not affect the status of servo drive. This function is used for output signal wiring check, etc. This operation must be performed in the servo off state by turning off SON.

##### Operation

Call the display screen after power on. Press the "MODE" key to show the diagnostic screen.

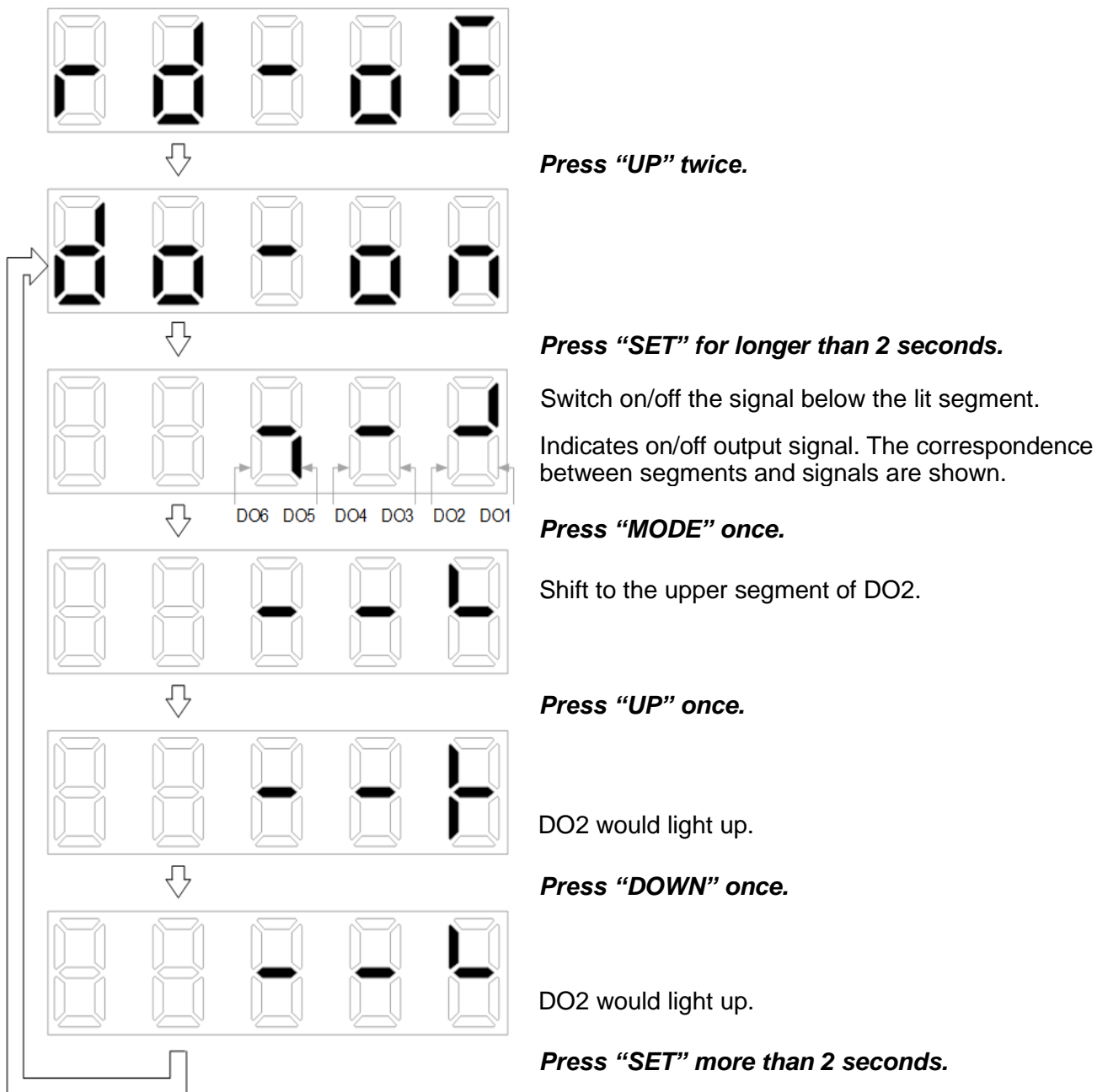

### 4.5.3. Test operation

#### (1) JOG operation

JOG operation could be performed when there is no command from the controller. The servo motor rotates while pressing the "UP" key to start CCW rotation or the "DOWN" key to start CW rotation. The servo motor stops rotating by releasing the key. The panel operation is described as follows.

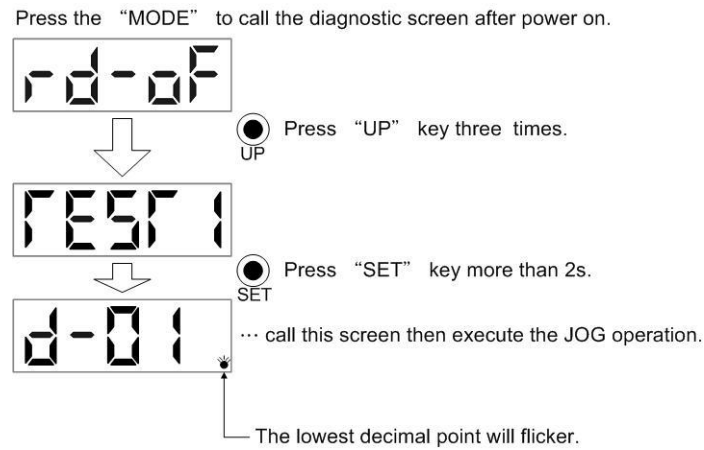

Set the rotation speed of JOG by the PC04, set the acceleration time by the PC01, and set the deceleration time by the PC02.

Pr.No	Sign	Function description	Setting range	Unit
PC01	STA	Acceleration time constant The time required to reach the rated speed from 0 rpm.	0 ~20000	ms
PC02	STB	Deceleration time constant The time required to reach 0 rpm from the rated speed.	0 ~20000	ms
PC04	JOG	JOG speed command To decide the JOG speed by sett this PC04 value.	-4500 ~4500	rpm

When the JOG operation is performed, if an emergency stop signal is required, please enable the EMG function by setting the related PD group parameter.

To terminate the JOG operation, turn off the power or press the "SET" key in operation test mode for more than 2 seconds to terminate the JOG operation.





(2) Positioning operation

Positioning operation could be performed when there is no command from the controller. The Shihlin communication software is required to perform this positioning operation. Before this operation, make sure that SON and SG are open.

(a) Operation

Make sure that the motor is correctly wired before this test performed. Select operation item via the Shihlin communication software. Press “Forward” or “Reverse” to rotate the motor which will then stop after moving the command route set by the user. Operation conditions could be modified by the Shihlin communication software. The initial values and setting ranges are listed in the table below:

Name		Default	Setting range
Rotary speed [rpm]		200	0~6000
Acceleration/deceleration time constant [ms]		1000	0~20000
Command route	Revolution [10000/turn]	10	0~512
	pulse	0	0~9999

(b) Description of the buttons

Button name	Function description
Forward	Press to run positioning operation in CCW.
Reverse	Press to run positioning operation in CW.
Pause	Press “Pause” button during operation to make a temporary stop. To press the same button which was pressed to finish the remaining route. Otherwise, to press "Pause" button again to erases the remaining route.
Close	Terminate this test.

### (3) Inertia estimation operation

Inertia estimation operation could be performed when there is no command from the controller. The Shihlin communication software is required to perform this Inertia estimation operation. Before this operation, the PA02 should be set as 0x00.

#### (a) Operation

- i. Click [Enable Auto Tuning Control Panel].
- ii. Set the parameters, like as acceleration/deceleration time constant, JOG speed.
- iii. Press [Servo ON] then the motor would be magnetized.
- iv. Press [←] or [→] to run the motor in CCW or CW.
- v. Press [Position 1] and [Position 2] to decide the proper route.
- vi. Press [Start] to execute this inertia estimation.
- vii. To observe the result of [inertia ratio].

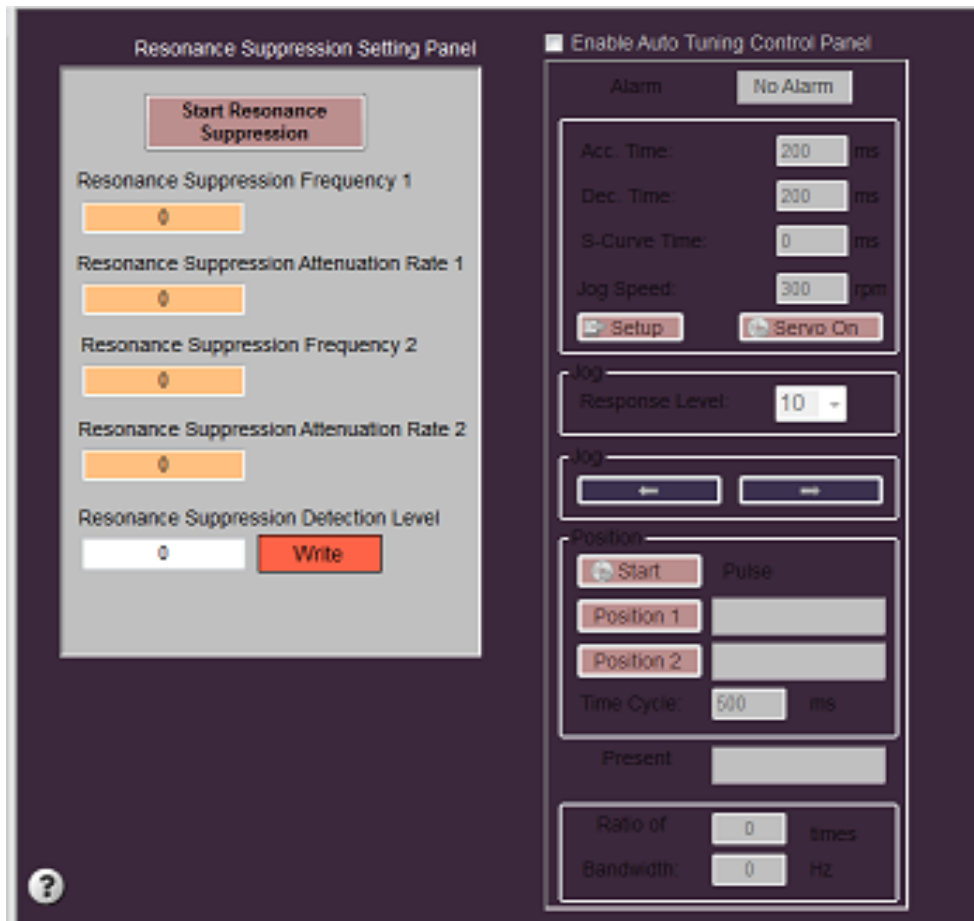

(b) Relevant parameter modification

After the Inertia estimation, some parameters related to control gain performance would be modified automatically.

Pr.No	Sign	Function description	Setting range	Unit
PB03	NLP	Resonance suppression low-pass filter	0 ~10000	0.1ms
PB05	FFC	Position feed-forward gain	0 ~200	%
PB06	GD1	Load to motor inertia ratio	0 ~1200	0.1time
PB07	PG1	Position loop gain	4 ~1024	rad/s
PB08	VG1	Speed loop gain	40 ~9000	rad/s
PB09	VIC	Speed integral gain	1 ~1000	ms

After the calculation completed, users must terminate the “Auto tuning control panel” in order to record the relevant parameters. If users already know the low frequency gain and inertia ratio of the system, they could also set the bandwidth value desired to calculate the optimum value for controller.

#### 4.6. Automatic offset of analog input

When the external speed analog command input is 0V, there may be still a offset voltage which will cause a slow motor rotation. The user could compensate this bias by the automatic offset function in the diagnostic display mode. Follow the steps to execute automatic offset of analog input:

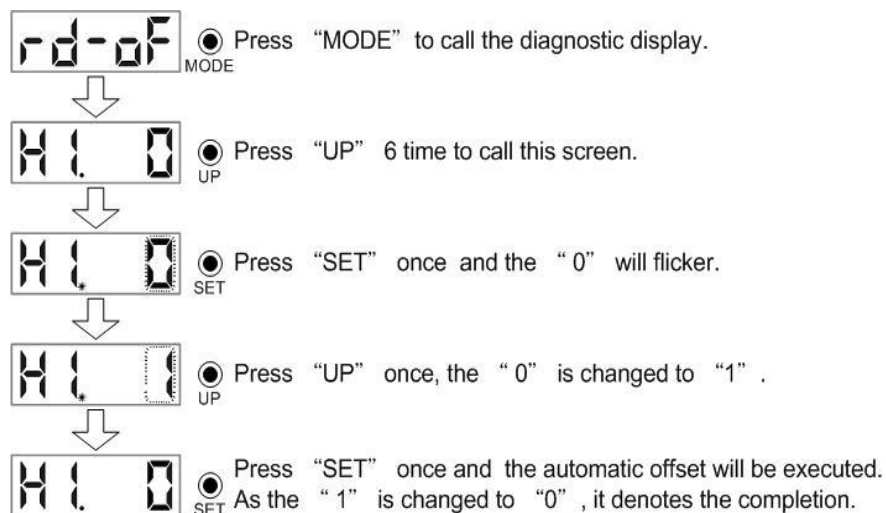

## 4.7. Alarm display

It displays the current alarm and the past alarm history. The lower two digits display the abnormal alarm number which has occurred.

Name	Display	Description
Current alarm	AL --	No alarm occurred.
	AL 01	Over voltage (AL 01) occurred, the screen flickers synchronously.
Alarm history	A0 01	Indicates that the last alarm is over voltage (AL 01).
	A1 02	Indicates that the 2nd alarm in the past is low voltage (AL 02).
	A2 03	Indicates that the 3rd alarm in the past is over current (AL 03).
	A3 04	Indicates that the 4th alarm in the past is regenerated error (AL 03).
	A4 05	Indicates that the 5th alarm in the past is over load (AL 05).
	A5 06	Indicates that the 6th alarm in the past is over speed (AL 06).

### Functions when abnormal alarm occurred

- (a) Any mode screen could display the current alarm.
- (b) The other screen could be read during the occurrence of an alarm.
- (c) Remove the cause of the alarm and clear it by one of the following methods.
  - i. Switch the power off, then power on the drive again.
  - ii. Press the "SET" key on the current alarm screen.
  - iii. Turn on the abnormal alarm reset signal (RES).
- (d) Move to the next record by pressing "UP" or "DOWN".

## 4.8. Parameter display

Some parameter modification would be valid by power off once and power on again.

(1) Decimal parameter (positive number)

Example: PA19 is 1234567, then to change to 1434567.



**Press "SET" once.**



The lower 5 digits of PA19 are shown and the lowest decimal point indicates that this is low screen.

**Press "MODE" once**



The higher 2 digits of PA19 are shown and the second decimal point indicates that this is high screen.

**Press "MODE" once**



The screen is returned to the low screen.

**Press "SET" once**

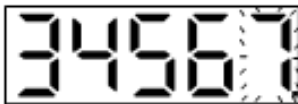

The lowest digit display would be flickering.

**Press "MODE" for 5 times.**



The flickering digit would shift left to the second high digit.

**Press "UP" twice.**



The flickering digit would be changed to "4".

**Press "SET" once to store the modification.**

(2) Decimal parameter (negative number)

Example: PA19 is 1234567, then to change to -1434567.



**Press "SET" once.**



The lower 5 digits of PA19 are shown and the lowest decimal point indicates that this is low screen

**Press "MODE" once.**



The higher 2 digits of PA19 are shown and the second decimal point indicates that this is high screen.

**Press "SET" once.**



The lowest digit of this screen would be flickering.

**Press "MODE" twice.**



The flickering digit shifts to the highest digit and the "-" sign appears.

**Press "SET" once.**



This screen will show "-1.2".The PA19 is -1234567 now.

Press "MODE" once.

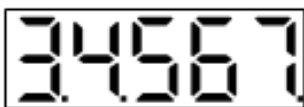

Return to the screen of -1234567 lower 5 digits. The left 2 decimal points indicate that this number is negative.

Press "UP" once.

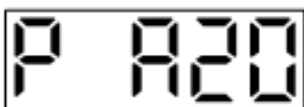

Scroll to the next parameter. (PA20)

(3) Hexadecimal parameter

Example: PE01 is 03760135, then to change to 0x03740135.



**Press "SET" once.**



The lower 4 digits of PE01 are shown and the underline of highest digit indicates that this is low word.

**Press "MODE" once.**



The higher 4 digits of PE01 are shown and the up segment of highest digit indicates that this is high word.

**Press "MODE" once.**

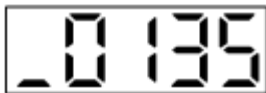

It shows the lower word again.

**Press "SET" twice.**

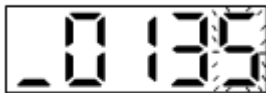

The lowest digit of PE01 would be flickering.

**Press "SET" 4 times.**



This flickering digit shifts to the lowest digit of high word.

**Press "DOWN" twice.**



The display shows the modification.

**Press "SET" once** to store the modification.

## 4.9. Startup in various control modes

Make a startup in accordance with section 4.1.

### 4.9.1. Startup in position control mode

#### (1) Power on

Switch off SON before the servo drive has powered on. After power on, the display shows “r”. (Motor speed)

#### (2) Test operation

Confirm the servo motor status with a JOG test.

#### (3) Parameters setting

After wiring for position mode, the following parameters should be set for this operation.

Parameter	Name	Setting value	Description
PA01	Control mode option	<input type="checkbox"/> <input type="checkbox"/> <input type="checkbox"/> <input type="checkbox"/> 0	Position control mode
PA02	Gain tuning mode option	0002	Auto-gain tuning mode 1
PA03	Auto-tuning response level setting	0012	Middle rigidity
PA06	Electronic gear numerator	1	Set the numerator as “1”
PA07	Electronic gear denominator	1	Set the denominator as “1”
PA13	Command pulse option	Setting corresponds with user’s signals.	
PD15	Digital input filter time option	<input type="checkbox"/> <input type="checkbox"/> <input type="checkbox"/> 2	Filter time constant is “4mS”

#### (4) Servo on

Turn on SON then the motor shaft is locked and ready to run.

#### (5) Command pulses input

First, make the servo motor run at a low speed and confirm the direction and operation of servo motor. If the pulse train commands are open collector type, PP and NP are input terminals. When line driver signals are applied, please choose PP-PG or NP-NG wirings.

#### (6) Home return

After executing this function, check whether the designate origin position has reached.

#### (7) Stop

Turn off SON or make EMG activated to stop running the servo motor.



#### 4.9.2. Startup in speed control mode

##### (1) Power on

Switch off SON before the servo drive has powered on. After power on, the display shows “r”. (Motor speed)

##### (2) Test operation

Confirm the servo motor status with a JOG test.

##### (3) Parameters setting

After wiring for speed mode, the following parameters should be set for this operation.

Parameter	Name	Setting value	Description
PA01	Control mode option	<input type="checkbox"/> <input type="checkbox"/> <input type="checkbox"/> 2	Speed control mode
PC01	Acceleration time constant	1000	A 1000mS time constant
PC02	Deceleration time constant	500	A 500ms time constant
PC03	S-pattern acc./dec. time constant	0	Disabled
PC05	Inner speed command/limit 1	1000	Speed command is 1000 rpm.
PC06	Inner speed command/limit 2	1500	Speed command is 1500 rpm.
PC07	Inner speed command/limit 3	2000	Speed command is 2000 rpm
PD15	Digital input filter time option	<input type="checkbox"/> <input type="checkbox"/> <input type="checkbox"/> 2	Filter time constant is “4ms”

##### (4) Servo on

Turn on SON then the motor shaft is locked and ready to run.

##### (5) Start

Choose the speed command with the SP1 and SP2 signals. Options are listed as below.

DI signal		Speed command
SP2	SP1	
0	0	Speed analog command(VC)
0	1	Inner speed command 1(PC05)
1	0	Inner speed command 2(PC06)
1	1	Inner speed command 3(PC07)

The rotary direction is decided with the ST1 and ST2 signals. Options are listed as below.

DI signal		Rotary direction for inner speed command
ST2	ST1	
0	0	Stop (servo lock)
0	1	CCW
1	0	CW
1	1	Stop (servo lock)

First, make the servo motor run at a low speed and check whether the sequence correct or not. With the status display, user can check the motor speed, cumulative pulses of command, effective load ratio, etc. Use auto tuning or manually input the gain parameters and avoid the machine resonance. Adjust the PA03 to obtain the optimum speed response.

(6) Home return

After executing this function, check whether the designate origin position has reached.

(7) Stop

Take one of the following steps to stop running the motor.

a. Turn off SON

The motor shaft becomes rotatable.

b. Alarm has occurred

The dynamic brake works and the motor suddenly stops running.

c. EMG is activated

The motor stops running then the abnormal message are shown.

d. LSP/LSN signal inactivated

LSP on is rotatable in CCW. LSN on is rotatable in CW. If they are off, the dynamic brake works.

e. If ST1 and ST2 are both on or both off, the motor would decelerate to stop.

### 4.9.3. Startup in torque control mode

(1) Power on

Switch off SON before the servo drive has powered on. After power on, the display shows “U”.  
(Analog torque command)

(2) Test operation

Confirm the servo motor status with a JOG test.

(3) Parameters setting

After wiring for torque mode, the following parameters should be set for this operation.

Parameter	Name	Setting value	Description
PA01	Control mode option	<input type="checkbox"/> <input type="checkbox"/> <input type="checkbox"/> 4	Torque control mode
PA05	Inner torque limit 1	50	Maximum torque 50% as a limit
PC01	Acceleration time constant	1000	A 1000ms time constant
PC02	Deceleration time constant	500	A 500ms time constant
PC03	S-pattern acc./dec. time constant	0	Disabled
PC05	Inner speed command/limit 1	1000	Speed limit is 1000 rpm.
PC06	Inner speed command/limit 2	1500	Speed limit is 1500 rpm.
PC07	Inner speed command/limit 3	2000	Speed limit is 2000 rpm
PD15	Digital input filter time option	<input type="checkbox"/> <input type="checkbox"/> <input type="checkbox"/> 2	Filter time constant is “4ms”

(4) Servo on

Turn on SON then the motor shaft is locked and ready to run.

(5) Start

Use SP1 and SP2 to select the speed limit. The motor runs in CCW when RS1 is activated. The motor runs in CW when RS2 is activated. First, run the motor at a low speed and check whether the sequence correct or not. If the sequence is unexpected, check input signal carefully.

(6) Stop

Take one of the following steps to stop running the motor.

a. Turn off SON

The motor shaft becomes rotatable.

b. Alarm has occurred

The dynamic brake works and the motor suddenly stops running.

c. EMG is activated

The motor stops running then the abnormal message are shown.

d. LSP/LSN signal inactivated

LSP on is rotatable in CCW. LSN on is rotatable in CW. If they are off, the dynamic brake works.

e. If ST1 and ST2 are both on or both off, the motor would decelerate to stop.

## 5. Parameters

### 5.1. Parameter definition

The parameters of SDE servo drive are classified into the basic parameters, gain/ filters, expansion parameters and I/O parameters. When an advance adjustment is required, change the parameter PA42 setting to make the expansion parameters valid.

Here are some notes for reading of parameter manual.

#### 1. Parameter classification

There is a parameter list which is classified due to the functions for user to consult conveniently. Refer to section 5.2 for more details.

#### 2. Special symbol of parameter sign

(★) denotes the setting is valid by power off once and power on again.

(■) denotes the setting is vanished once power off.

(▲) denotes the invalid change as the Servo ON activated.

There are 2 ways to make Servo ON disabled.

(1) Turn off the SON DI signal.

(2) Set the PD16 as 1 and the drive would be at Servo OFF state. But remember to recover it after the completion of modification.

Group classification according to different functions is listed below.

Group	Description
Basic parameter (No PA□□)	Used to perform the position control. Please set this parameter group.
Gain, filter (No PB□□)	Used to perform the manual-gain tuning. Please set this parameter group.
Expansion (No PC□□)	As speed or torque control is required, please set this parameter group.
I/O settings (No PD□□)	Used to change the states of I/O signal. Please set this parameter group.

The control mode is described as follows.

Mode	Sign	Description
Single mode	Position control (terminal input)	Pt Drive runs motor to reach the goal according to the external commands which are received through the CN1 and are in the form of pulse trains.
	Position control (inner register)	Pr Drive runs motor to reach the goal according to the inner commands which are from inner 8 registers that could be switched by DI signals.
	Speed control	S Drive runs motor to attain the target speed. The command type which is an analog voltage or the inner registers could be switched by DI.
	Torque control	T The drive receives the commands to run the motor to generate the demanded torque. The command source is the analog voltage.
Mode switched	Pt-S	Pt/S is switched mutually via the LOP signal.
	Pt-T	Pt/T is switched mutually via the LOP signal.
	Pr-S	Pr/S is switched mutually via the LOP signal.
	Pr-T	Pr/T is switched mutually via the LOP signal.
	S-T	S/T is switched mutually via the LOP signal.

## 5.2. Parameter list

The parameters of Shihlin servo drive could be classify into 5 categories. PA group is basic for control mode option, auto-tuning, etc. PB group is for gain and filter functions. PC group is related to speed/torque control and analog I/O and communication functions. PD group is for DI/DO parameters. The following table is helpful to consult.

### (1) Basic parameters

NO	Abbr.	Name	Default	Unit	Control mode			
					Pt	Pr	S	T
PA01(★)	STY	Control mode option	1000h	-	<input type="radio"/>	<input type="radio"/>	<input type="radio"/>	<input type="radio"/>
PA02(▲)	ATUM	Gain tuning mode option	0002h	-	<input type="radio"/>	<input type="radio"/>	<input type="radio"/>	
PA03	ATUL	Auto-tuning response level setting	10	-	<input type="radio"/>	<input type="radio"/>	<input type="radio"/>	
PA04	HMOV	Home moving option	0000h	-		<input type="radio"/>		
PA05	TL1	Inner torque limit 1	100	%	<input type="radio"/>	<input type="radio"/>	<input type="radio"/>	<input type="radio"/>
PA06	CMX	Electronic gear numerator	1	-	<input type="radio"/>	<input type="radio"/>		
PA07(▲)	CDV	Electronic gear denominator	1	-	<input type="radio"/>	<input type="radio"/>		
PA08	HSPD1	Home moving high speed option 1	100	rpm		<input type="radio"/>		
PA09	HSPD2	Home moving high speed option 2	20	rpm		<input type="radio"/>		
PA10	RES1	Regenerated resistor value	-	ohm		<input type="radio"/>		
PA11	RES2	Regenerated resistor capacity	-	watt		<input type="radio"/>		
PA12	INP	In-position range	41943	Pulse	<input type="radio"/>	<input type="radio"/>		
PA13(★)	PLSS	Command pulse option	0000h	-	<input type="radio"/>			
PA14(★)	ENR	Encoder output pulses	10000	pulse/rev	<input type="radio"/>	<input type="radio"/>	<input type="radio"/>	<input type="radio"/>
PA15	CRSHA	Motor crash protection level (percentage)	0	%	<input type="radio"/>	<input type="radio"/>	<input type="radio"/>	<input type="radio"/>
PA16	CRSHT	Motor crash protection (time)	1	ms	<input type="radio"/>	<input type="radio"/>	<input type="radio"/>	<input type="radio"/>
PA17	OVL	Output overload warning level	120	%	<input type="radio"/>	<input type="radio"/>	<input type="radio"/>	<input type="radio"/>
PA18	OVS	Overspeed warning	5500	rpm	<input type="radio"/>	<input type="radio"/>	<input type="radio"/>	<input type="radio"/>
PA19	OVPE	Position error excess	3x 2 <sup>22</sup>	pulse	<input type="radio"/>	<input type="radio"/>		
PA20(★)	OVPL1	Position pulse frequency excess level 1	4500	KHz	<input type="radio"/>			
PA21(★)		Reserved						
PA22(★)	DBF	Dynamic brake control	0	-	<input type="radio"/>	<input type="radio"/>	<input type="radio"/>	<input type="radio"/>
PA23(■)	MCS	Memory write-inhibit function	0	-	<input type="radio"/>	<input type="radio"/>	<input type="radio"/>	<input type="radio"/>
PA24~PA27		Reserved						
PA28(★)	ABS	Absolute encoder settings	0000h	-	<input type="radio"/>	<input type="radio"/>	<input type="radio"/>	<input type="radio"/>
PA29(■)	CAP	Absolute homing position	0000h	-	<input type="radio"/>	<input type="radio"/>	<input type="radio"/>	<input type="radio"/>
PA30(■)	UAP	Update encoder absolute position	0	-	<input type="radio"/>	<input type="radio"/>	<input type="radio"/>	<input type="radio"/>
PA31	APST	Absolute coordinate system state	0000h	-	<input type="radio"/>	<input type="radio"/>	<input type="radio"/>	<input type="radio"/>

PA32	APR	Encoder absolute position (rev)	0	rev	<input type="radio"/>	<input type="radio"/>	<input type="radio"/>	<input type="radio"/>
PA33	APP	Encoder absolute position (pulse)	0	pulse	<input type="radio"/>	<input type="radio"/>	<input type="radio"/>	<input type="radio"/>
PA34(★)	ABSM	I/O communication of absolute system	0	-	<input type="radio"/>	<input type="radio"/>	<input type="radio"/>	<input type="radio"/>
PA35(★)	FNO1	Function option 1	0000h	-	<input type="radio"/>	<input type="radio"/>	<input type="radio"/>	<input type="radio"/>
PA36(★)	FNO2	Function option 2	0000h	-	<input type="radio"/>	<input type="radio"/>	<input type="radio"/>	<input type="radio"/>
PA37(★)	FNO3	Function option 3	0000h	-	<input type="radio"/>	<input type="radio"/>	<input type="radio"/>	<input type="radio"/>
PA38	Reserved							
PA39(★)	POL	Motor rotary direction option	0000h	-	<input type="radio"/>	<input type="radio"/>	<input type="radio"/>	<input type="radio"/>
PA40(▲)	SPW	Special parameter write-enable	0000h	-	<input type="radio"/>	<input type="radio"/>	<input type="radio"/>	<input type="radio"/>
PA41	POSPD	Max. speed setting of pulse output	5500	rpm	<input type="radio"/>	<input type="radio"/>	<input type="radio"/>	<input type="radio"/>
PA42(★)	BLK	Parameter write-inhibit	0000h	-	<input type="radio"/>	<input type="radio"/>	<input type="radio"/>	<input type="radio"/>
PA43(★)	ENB	Encoder brand	0001h	-	<input type="radio"/>	<input type="radio"/>	<input type="radio"/>	<input type="radio"/>
PA44(★)	EGM	Electronic gear ratio option	0	-	<input type="radio"/>	<input type="radio"/>		
PA45(▲)	FBP	Output pulse number per revolution	10000	pulse	<input type="radio"/>	<input type="radio"/>		
PA46~PA50	Reserved							

## (2) Gain, filter parameters

NO	Abbr.	Name	Default	Unit	Control mode			
					Pt	Pr	S	T
PB01	NHF1	Machine resonance suppression filter 1	1000	Hz	<input type="radio"/>	<input type="radio"/>	<input type="radio"/>	<input type="radio"/>
PB02	NHD1	Machine resonance suppression attenuation 1	0	dB	<input type="radio"/>	<input type="radio"/>	<input type="radio"/>	<input type="radio"/>
PB03	NLP	Resonance suppression low-pass filter	0	0.1ms	<input type="radio"/>	<input type="radio"/>	<input type="radio"/>	<input type="radio"/>
PB04	PST	Position command filter time constant	3	ms	<input type="radio"/>	<input type="radio"/>		
PB05	FFC	Position feed-forward gain	0	%	<input type="radio"/>	<input type="radio"/>		
PB06	GD1	Load to motor inertia ratio	70	0.1time	<input type="radio"/>	<input type="radio"/>	<input type="radio"/>	
PB07	PG1	Position loop gain	35	rad/s	<input type="radio"/>	<input type="radio"/>		
PB08	VG1	Speed loop gain	183	rad/s	<input type="radio"/>	<input type="radio"/>	<input type="radio"/>	
PB09	VIC	Speed integral gain	34	ms	<input type="radio"/>	<input type="radio"/>	<input type="radio"/>	
PB10	VFG	Speed feed-forward gain	0	%			<input type="radio"/>	
PB11(★)	CDP	Gain switch condition	0000h	-	<input type="radio"/>	<input type="radio"/>	<input type="radio"/>	
PB12	CDS	Gain switch condition value	10	depends	<input type="radio"/>	<input type="radio"/>	<input type="radio"/>	
PB13	CDT	Gain switch time constant	1	ms	<input type="radio"/>	<input type="radio"/>	<input type="radio"/>	
PB14	GD2	The ratio 2 of load inertia to motor shaft	70	0.1time	<input type="radio"/>	<input type="radio"/>	<input type="radio"/>	
PB15	PG2	Position loop gain change ratio	100	%	<input type="radio"/>	<input type="radio"/>		
PB16	VG2	Speed loop gain change ratio	100	%	<input type="radio"/>	<input type="radio"/>	<input type="radio"/>	

PB17	VIC2	Speed integral gain change ratio	100	%	<input type="radio"/>	<input type="radio"/>	<input type="radio"/>	
PB18	SFLT	Speed low-pass filter smooth time constant	0	ms			<input type="radio"/>	<input type="radio"/>
PB19	TQC	Torque command filter time constant	0	ms				<input type="radio"/>
PB20	SJIT	Speed feedback filter time constant	0	0.1ms	<input type="radio"/>	<input type="radio"/>	<input type="radio"/>	<input type="radio"/>
PB21	NHF2	Machine resonance suppression filter 2	1000	Hz	<input type="radio"/>	<input type="radio"/>	<input type="radio"/>	<input type="radio"/>
PB22	NHD2	Machine resonance suppression attenuation 2	0	dB	<input type="radio"/>	<input type="radio"/>	<input type="radio"/>	<input type="radio"/>
PB23	MVS	Motor noise suppression option	0	-	<input type="radio"/>	<input type="radio"/>		
PB24	VDC	Speed differential compensation	980	-	<input type="radio"/>	<input type="radio"/>	<input type="radio"/>	
PB25	NHF3	Machine resonance suppression filter 3	1000	Hz	<input type="radio"/>	<input type="radio"/>	<input type="radio"/>	<input type="radio"/>
PB26	NHD3	Machine resonance suppression attenuation 3	0	dB	<input type="radio"/>	<input type="radio"/>	<input type="radio"/>	<input type="radio"/>
PB27	ANCF	Auto resonance suppression mode	1	-	<input type="radio"/>	<input type="radio"/>	<input type="radio"/>	<input type="radio"/>
PB28	ANCL	Resonance suppression detection level	50	%	<input type="radio"/>	<input type="radio"/>	<input type="radio"/>	<input type="radio"/>
PB29	AVSM	Auto vibration suppression mode	0	-	<input type="radio"/>	<input type="radio"/>		
PB30	VCL	Low-frequency vibration detection level	50	pulse	<input type="radio"/>	<input type="radio"/>		
PB31	VSF1	Vibration suppression frequency 1	100	0.1Hz	<input type="radio"/>	<input type="radio"/>		
PB32	VSG1	Vibration suppression gain 1	0	-	<input type="radio"/>	<input type="radio"/>		
PB33	VSF2	Vibration suppression frequency 2	100	0.1Hz	<input type="radio"/>	<input type="radio"/>		
PB34	VSG2	Vibration suppression gain 2	0	-	<input type="radio"/>	<input type="radio"/>		
PB35	FRCL	Friction compensation level	0	%	<input type="radio"/>	<input type="radio"/>	<input type="radio"/>	
PB36	FRCT	Friction compensation filter time constant	0	ms	<input type="radio"/>	<input type="radio"/>	<input type="radio"/>	
PB37	FRCM	Friction compensation option	0	-	<input type="radio"/>	<input type="radio"/>	<input type="radio"/>	
PB38	FFCT	Position feed forward filter time constant	0	ms	<input type="radio"/>	<input type="radio"/>		
PB39~PB43		Reserved						
PB44	PPD	Position loop differential gain	0	rad/s	<input type="radio"/>	<input type="radio"/>		
PB45~PB48		Reserved						
PB49	DOB	Disturbance observer gain	0	-	<input type="radio"/>	<input type="radio"/>	<input type="radio"/>	<input type="radio"/>
PB50		Reserved						

### (3) Expansion parameters

NO	Abbr.	Name	Default	Unit	Control mode			
					Pt	Pr	S	T
PC01	STA	Acceleration time constant	200	ms		<input type="radio"/>	<input type="radio"/>	<input type="radio"/>
PC02	STB	Deceleration time constant	200	ms		<input type="radio"/>	<input type="radio"/>	<input type="radio"/>
PC03	STC	S-pattern acc./dec. time constant	0	ms		<input type="radio"/>	<input type="radio"/>	<input type="radio"/>
PC04	JOG	JOG speed command	300	rpm	<input type="radio"/>	<input type="radio"/>	<input type="radio"/>	<input type="radio"/>

PC05	SC1	Inner speed command/limit 1	100	rpm			○	○
PC06	SC2	Inner speed command/limit 2	500	rpm			○	○
PC07	SC3	Inner speed command/limit 3	1000	rpm			○	○
PC08	SC4	Inner speed command/limit 4	200	rpm			○	○
PC09	SC5	Inner speed command/limit 5	300	rpm			○	○
PC10	SC6	Inner speed command/limit 6	500	rpm			○	○
PC11	SC7	Inner speed command/limit 7	800	rpm			○	○
PC12(▲)	VCM	Output speed of maximum analog command	3000	rpm			○	○
PC13(▲)	TLC	Torque generated of maximum analog command	100	%	○	○	○	○
PC14	MOD	Analog monitor output	0100h	-	○	○	○	○
PC15(★)	SVZR	Speed analog zero voltage acknowledged range	10	mV			○	○
PC16	MBR	Electromagnetic brake output delay time	100	ms	○	○	○	○
PC17	ZSP	Zero speed acknowledged range	50	rpm	○	○	○	○
PC18(★)	COP1	Stop option and power interruption restart option	0010h	-	○	○	○	○
PC19(★)	COP2	Alarm history clear option	0000h	-	○	○	○	○
PC20(★)	SNO	Communication device number	1	-	○	○	○	○
PC21(★)	CMS	Communication mode option	0010h	-	○	○	○	○
PC22(★)	BPS	Communication protocol option	0010h	-	○	○	○	○
PC23	SIC	Communication time-out process option	0	s	○	○	○	○
PC24(★)	DMD	Status display option	0000h	-	○	○	○	○
PC25	TL2	Inner torque limit 2	100	%	○	○	○	○
PC26	VCO	Speed analog command/limit offset	0	mV			○	○
PC27	TLO	Torque analog command/limit offset	0	mV			○	○
PC28	MO1	Analog monitor ch1 offset	0	mV	○	○	○	○
PC29	MO2	Analog monitor ch2 offset	0	mV	○	○	○	○
PC30	MOG1	Analog monitor ch1 output proportion	100	%	○	○	○	○
PC31	MOG2	Analog monitor ch2 output proportion	100	%	○	○	○	○
PC32	CMX2	Electronic gear numerator 2	1	-	○	○		
PC33	CMX3	Electronic gear numerator 3	1	-	○	○		
PC34	CMX4	Electronic gear numerator 4	1	-	○	○		
PC35(★)	VCL	VC voltage limit	0	mV			○	○
PC36	VFMT	VC/VLA linear voltage filter time constant	0	0.1ms	○	○	○	○
PC37(■)	DTA9	AL09 occurrence delay time	0	ms	○	○	○	○
PC38	FNO4	Function option 4	0000h	-	○	○	○	○
PC39		Reserved						
PC40	MBR1	Electromagnetic brake enable delay time	0	ms	○	○	○	○
PC41~PC60		Reserved						



#### (4) I/O setting parameters

NO	Abbr.	Name	Default	Unit	Control mode			
					Pt	Pr	S	T
PD01(★)	DIA1	Digital input signal auto-ON option 1	0000h	-	<input type="radio"/>	<input type="radio"/>	<input type="radio"/>	<input type="radio"/>
PD02(★)	DI1	Digital input 1 option	0001h	-	<input type="radio"/>	<input type="radio"/>	<input type="radio"/>	<input type="radio"/>
PD03(★)	DI2	Digital input 2 option	000Dh	-	<input type="radio"/>	<input type="radio"/>	<input type="radio"/>	<input type="radio"/>
PD04(★)	DI3	Digital input 3 option	0003h	-	<input type="radio"/>	<input type="radio"/>	<input type="radio"/>	<input type="radio"/>
PD05(★)	DI4	Digital input 4 option	0004h	-	<input type="radio"/>	<input type="radio"/>	<input type="radio"/>	<input type="radio"/>
PD06(★)	DI5	Digital input 5 option	0002h	-	<input type="radio"/>	<input type="radio"/>	<input type="radio"/>	<input type="radio"/>
PD07(★)	DI6	Digital input 6 option	000Fh	-	<input type="radio"/>	<input type="radio"/>	<input type="radio"/>	<input type="radio"/>
PD08(★)	DI7	Digital input 7 option	0012h	-	<input type="radio"/>	<input type="radio"/>	<input type="radio"/>	<input type="radio"/>
PD09(★)	DI8	Digital input 8 option	0011h	-	<input type="radio"/>	<input type="radio"/>	<input type="radio"/>	<input type="radio"/>
PD10(★)	DO1	Digital output 1 option	0003h	-	<input type="radio"/>	<input type="radio"/>	<input type="radio"/>	<input type="radio"/>
PD11(★)	DO2	Digital output 2 option	0008h	-	<input type="radio"/>	<input type="radio"/>	<input type="radio"/>	<input type="radio"/>
PD12(★)	DO3	Digital output 3 option	0007h	-	<input type="radio"/>	<input type="radio"/>	<input type="radio"/>	<input type="radio"/>
PD13(★)	DO4	Digital output 4 option	0005h	-	<input type="radio"/>	<input type="radio"/>	<input type="radio"/>	<input type="radio"/>
PD14(★)	DO5	Digital output 5 option	0001h	-	<input type="radio"/>	<input type="radio"/>	<input type="radio"/>	<input type="radio"/>
PD15(★)	DIF	Digital input filter time option	0002h	-	<input type="radio"/>	<input type="radio"/>	<input type="radio"/>	<input type="radio"/>
PD16(■)	IOS	Digital input on/off control source option	0000h	-	<input type="radio"/>	<input type="radio"/>	<input type="radio"/>	<input type="radio"/>
PD17(★)	DOP1	LSP/LSN triggered stop option	0000h	-	<input type="radio"/>	<input type="radio"/>	<input type="radio"/>	<input type="radio"/>
PD18(★)	DOP2	CR signal clear option	0000h	-	<input type="radio"/>	<input type="radio"/>	<input type="radio"/>	<input type="radio"/>
PD19(★)	DOP3	Alarm code output option	0000h	-	<input type="radio"/>	<input type="radio"/>	<input type="radio"/>	<input type="radio"/>
PD20(★)	DOP4	Alarm reset triggered process	0000h	-	<input type="radio"/>	<input type="radio"/>	<input type="radio"/>	<input type="radio"/>
PD21(★)	DI9	Digital input 9 option	0000h	-	<input type="radio"/>	<input type="radio"/>	<input type="radio"/>	<input type="radio"/>
PD22(★)	DI10	Digital input 10 option	0000h	-	<input type="radio"/>	<input type="radio"/>	<input type="radio"/>	<input type="radio"/>
PD23(★)	DI11	Digital input 11 option	0000h	-	<input type="radio"/>	<input type="radio"/>	<input type="radio"/>	<input type="radio"/>
PD24(★)	DI12	Digital input 12 option	0000h	-	<input type="radio"/>	<input type="radio"/>	<input type="radio"/>	<input type="radio"/>
PD25(■)	ITST	Communication control DI on/off	0000h	-	<input type="radio"/>	<input type="radio"/>	<input type="radio"/>	<input type="radio"/>
PD26(★)	DO6	Digital output 6 option	0002h	-	<input type="radio"/>	<input type="radio"/>	<input type="radio"/>	<input type="radio"/>
PD27(★)	DOD	DO signal contact definition	0000h	-	<input type="radio"/>	<input type="radio"/>	<input type="radio"/>	<input type="radio"/>
PD28	MCOK	Motion completion option	0000h	-	<input type="radio"/>	<input type="radio"/>	<input type="radio"/>	<input type="radio"/>
PD29(★)	DID	DI signal contact definition	0000h	-	<input type="radio"/>	<input type="radio"/>	<input type="radio"/>	<input type="radio"/>
PD30(■)	SDO	Switch of DO control source (turret application)	0000h	-	<input type="radio"/>	<input type="radio"/>	<input type="radio"/>	<input type="radio"/>
PD31(■)	OTST	Communication control DO on/off	0000h	-	<input type="radio"/>	<input type="radio"/>	<input type="radio"/>	<input type="radio"/>
PD32(★)	SDLY	Servo ON delay time	0	-	<input type="radio"/>	<input type="radio"/>	<input type="radio"/>	<input type="radio"/>
PD33~PD40		Reserved						

**(5) Pr stroke 1 programming parameters**

NO	Abbr.	Name	Default	Unit	Control mode			
					Pt	Pr	S	T
PE01	ODEF	Origin return definition	0000h	-		<input type="radio"/>		
PE02	ODAT	Origin offset value definition	0	-		<input type="radio"/>		
PE03	PDEF1	PATH#1 definition	0000h	-		<input type="radio"/>		
PE04	PDAT1	PATH#1 data	0	-		<input type="radio"/>		
PE05	PDEF2	PATH#2 definition	0000h	-		<input type="radio"/>		
PE06	PDAT2	PATH#2 data	0	-		<input type="radio"/>		
PE07	PDEF3	PATH#3 definition	0000h	-		<input type="radio"/>		
PE08	PDAT3	PATH#3 data	0	-		<input type="radio"/>		
PE09	PDEF4	PATH#4 definition	0000h	-		<input type="radio"/>		
PE10	PDAT4	PATH#4 data	0	-		<input type="radio"/>		
PE11	PDEF5	PATH#5 definition	0000h	-		<input type="radio"/>		
PE12	PDAT5	PATH#5 data	0	-		<input type="radio"/>		
PE13	PDEF6	PATH#6 definition	0000h	-		<input type="radio"/>		
PE14	PDAT6	PATH#6 data	0	-		<input type="radio"/>		
PE15	PDEF7	PATH#7 definition	0000h	-		<input type="radio"/>		
PE16	PDAT7	PATH#7 data	0	-		<input type="radio"/>		
PE17	PDEF8	PATH#8 definition	0000h	-		<input type="radio"/>		
PE18	PDAT8	PATH#8 data	0	-		<input type="radio"/>		
PE19	PDEF9	PATH#9 definition	0000h	-		<input type="radio"/>		
PE20	PDAT9	PATH#9 data	0	-		<input type="radio"/>		
PE21	PDEF10	PATH#10 definition	0000h	-		<input type="radio"/>		
PE22	PDAT10	PATH#10 data	0	-		<input type="radio"/>		
PE23	PDEF11	PATH#11 definition	0000h	-		<input type="radio"/>		
PE24	PDAT11	PATH#11 data	0	-		<input checked="" type="radio"/>		
PE25	PDEF12	PATH#12 definition	0000h	-		<input checked="" type="radio"/>		
PE26	PDAT12	PATH#12 data	0	-		<input checked="" type="radio"/>		
PE27	PDEF13	PATH#13 definition	0000h	-		<input checked="" type="radio"/>		
PE28	PDAT13	PATH#13 data	0	-		<input checked="" type="radio"/>		
PE29	PDEF14	PATH#14 definition	0000h	-		<input type="radio"/>		
PE30	PDAT14	PATH#14 data	0	-		<input type="radio"/>		
PE31	PDEF15	PATH#15 definition	0000h	-		<input type="radio"/>		

PE32	PDAT15	PATH#15 data	0	-		○		
PE33	PDEF16	PATH#16 definition	0000h	-		○		
PE34	PDAT16	PATH#16 data	0	-		○		
PE35	PDEF17	PATH#17 definition	0000h	-		○		
PE36	PDAT17	PATH#17 data	0	-		○		
PE37	PDEF18	PATH#18 definition	0000h	-		○		
PE38	PDAT18	PATH#18 data	0	-		○		
PE39	PDEF19	PATH#19 definition	0000h	-		○		
PE40	PDAT19	PATH#19 data	0	-		○		
PE41	PDEF20	PATH#20 definition	0000h	-		○		
PE42	PDAT20	PATH#20 data	0	-		○		
PE43	PDEF21	PATH#21 definition	0000h	-		○		
PE44	PDAT21	PATH#21 data	0	-		○		
PE45	PDEF22	PATH#22 definition	0000h	-		○		
PE46	PDAT22	PATH#22 data	0	-		○		
PE47	PDEF23	PATH#23 definition	0000h	-		○		
PE48	PDAT23	PATH#23 data	0	-		○		
PE49	PDEF24	PATH#24 definition	0000h	-		○		
PE50	PDAT24	PATH#24 data	0	-		○		
PE51	PDEF25	PATH#25 definition	0000h	-		○		
PE52	PDAT25	PATH#25 data	0	-		○		
PE53	PDEF26	PATH#26 definition	0000h	-		○		
PE54	PDAT26	PATH#26 data	0	-		○		
PE55	PDEF27	PATH#27 definition	0000h	-		○		
PE56	PDAT27	PATH#27 data	0	-		○		
PE57	PDEF28	PATH#28 definition	0000h	-		○		
PE58	PDAT28	PATH#28 data	0	-		○		
PE59	PDEF29	PATH#29 definition	0000h	-		○		
PE60	PDAT29	PATH#29 data	0	-		○		
PE61	PDEF30	PATH#30 definition	0000h	-		○		
PE62	PDAT30	PATH#30 data	0	-		○		
PE63	PDEF31	PATH#31 definition	0000h	-		○		
PE64	PDAT31	PATH#31 data	0	-		○		
PE65	PDEF32	PATH#32 definition	0000h	-		○		
PE66	PDAT32	PATH#32 data	0	-		○		

PE67	PDEF33	PATH#33 definition	0000h	-		○		
PE68	PDAT33	PATH#33 data	0	-		○		
PE69	PDEF34	PATH#34 definition	0000h	-		○		
PE70	PDAT34	PATH#34 data	0	-		○		
PE71	PDEF35	PATH#35 definition	0000h	-		○		
PE72	PDAT35	PATH#35 data	0	-		○		
PE73	PDEF36	PATH#36 definition	0000h	-		○		
PE74	PDAT36	PATH#36 data	0	-		○		
PE75	PDEF37	PATH#37 definition	0000h	-		○		
PE76	PDAT37	PATH#37 data	0	-		○		
PE77	PDEF38	PATH#38 definition	0000h	-		○		
PE78	PDAT38	PATH#38 data	0	-		○		
PE79	PDEF39	PATH#39 definition	0000h	-		○		
PE80	PDAT39	PATH#39 data	0	-		○		
PE81	PDEF40	PATH#40 definition	0000h	-		○		
PE82	PDAT40	PATH#40 data	0	-		○		
PE83	PDEF41	PATH#41 definition	0000h	-		○		
PE84	PDAT41	PATH#41 data	0	-		○		
PE85	PDEF42	PATH#42 definition	0000h	-		○		
PE86	PDAT42	PATH#42 data	0	-		○		
PE87	PDEF43	PATH#43 definition	0000h	-		○		
PE88	PDAT43	PATH#43 data	0	-		○		
PE89	PDEF44	PATH#44 definition	0000h	-		○		
PE90	PDAT44	PATH#44 data	0	-		○		
PE91	PDEF45	PATH#45 definition	0000h	-		○		
PE92	PDAT45	PATH#45 data	0	-		○		
PE93	PDEF46	PATH#46 definition	0000h	-		○		
PE94	PDAT46	PATH#46 data	0	-		○		
PE95	PDEF47	PATH#47 definition	0000h	-		○		
PE96	PDAT47	PATH#47 data	0	-		○		
PE97	PDEF48	PATH#48 definition	0000h	-		○		
PE98	PDAT48	PATH#48 data	0	-		○		
PE99		Reserved						

**(6) Pr stroke 2 programming parameters**

NO	Abbr.	Name	Default	Unit	Control mode			
					Pt	Pr	S	T
PF01	PDEF49	PATH#49 data	0000h	-		<input type="radio"/>		
PF02	PDAT49	PATH#49 definition	0	-		<input type="radio"/>		
PF03	PDEF50	PATH#50 data	0000h	-		<input type="radio"/>		
PF04	PDAT50	PATH#50 definition	0	-		<input type="radio"/>		
PF05	PDEF51	PATH#51 definition	0000h	-		<input type="radio"/>		
PF06	PDAT51	PATH#51 data	0	-		<input type="radio"/>		
PF07	PDEF52	PATH#52 definition	0000h	-		<input type="radio"/>		
PF08	PDAT52	PATH#52 data	0	-		<input type="radio"/>		
PF09	PDEF53	PATH#53 definition	0000h	-		<input type="radio"/>		
PF10	PDAT53	PATH#53 data	0	-		<input type="radio"/>		
PF11	PDEF54	PATH#54 definition	0000h	-		<input type="radio"/>		
PF12	PDAT54	PATH#54 data	0	-		<input type="radio"/>		
PF13	PDEF55	PATH#55 definition	0000h	-		<input type="radio"/>		
PF14	PDAT55	PATH#55 data	0	-		<input type="radio"/>		
PF15	PDEF56	PATH#56 definition	0000h	-		<input type="radio"/>		
PF16	PDAT56	PATH#56 data	0	-		<input type="radio"/>		
PF17	PDEF57	PATH#57 definition	0000h	-		<input type="radio"/>		
PF18	PDAT57	PATH#57 data	0	-		<input type="radio"/>		
PE19	PDEF58	PATH#58 definition	0000h	-		<input type="radio"/>		
PF20	PDAT58	PATH#58 data	0	-		<input type="radio"/>		
PF21	PDEF59	PATH#59 definition	0000h	-		<input type="radio"/>		
PF22	PDAT59	PATH#59 data	0	-		<input type="radio"/>		
PF23	PDEF60	PATH#60 definition	0000h	-		<input type="radio"/>		
PF24	PDAT60	PATH#60 data	0	-		<input type="radio"/>		
PF25	PDEF61	PATH#61 definition	0000h	-		<input type="radio"/>		
PF26	PDAT61	PATH#61 data	0	-		<input type="radio"/>		
PF27	PDEF62	PATH#62 definition	0000h	-		<input type="radio"/>		
PF28	PDAT62	PATH#62 data	0	-		<input type="radio"/>		
PF29	PDEF63	PATH#63 definition	0000h	-		<input type="radio"/>		
PF30	PDAT63	PATH#63 data	0	-		<input type="radio"/>		
PF31~PF32		Reserved						
PF33	POV1	Inner position 1 velocity	50	rpm		<input type="radio"/>		

PF34	POV2	Inner position 2 velocity	10	rpm		○		
PF35	POV3	Inner position 3 velocity	200	rpm		○		
PF36	POV4	Inner position 4 velocity	300	rpm		○		
PF37	POV5	Inner position 5 velocity	500	rpm		○		
PF38	POV6	Inner position 6 velocity	800	rpm		○		
PF39	POV7	Inner position 7 velocity	1000	rpm		○		
PF40	POV8	Inner position 8 velocity	1200	rpm		○		
PF41	POV9	Inner position 9 velocity	1500	rpm		○		
PF42	POV10	Inner position 10 velocity	1800	rpm		○		
PF43	POV11	Inner position 11 velocity	2000	rpm		○		
PF44	POV12	Inner position 12 velocity	2200	rpm		○		
PF45	POV13	Inner position 13 velocity	2400	rpm		○		
PF46	POV14	Inner position 14 velocity	2700	rpm		○		
PF47	POV15	Inner position 15 velocity	3000	rpm		○		
PF48	POV16	Inner position 16 velocity	3000	rpm		○		
PF49	POA1	Inner position 1 acc./dec. time	200	ms		○		
PF50	POA2	Inner position 2 acc./dec. time	300	ms		○		
PF51	POA3	Inner position 3 acc./dec. time	500	ms		○		
PF52	POA4	Inner position 4 acc./dec. time	600	ms		○		
PF53	POA5	Inner position 5 acc./dec. time	800	ms		○		
PF54	POA6	Inner position 6 acc./dec. time	900	ms		○		
PF55	POA7	Inner position 7 acc./dec. time	1000	ms		○		
PF56	POA8	Inner position 8 acc./dec. time	1200	ms		○		
PF57	POA9	Inner position 9 acc./dec. time	1400	ms		○		
PF58	POA10	Inner position 10 acc./dec. time	1600	ms		○		
PF59	POA11	Inner position 11 acc./dec. time	2000	ms		○		
PF60	POA12	Inner position 12 acc./dec. time	2500	ms		○		
PF61	POA13	Inner position 13 acc./dec. time	3000	ms		○		
PF62	POA14	Inner position 14 acc./dec. time	4000	ms		○		
PF63	POA15	Inner position 15 acc./dec. time	5000	ms		○		
PF64	POA16	Inner position 16 acc./dec. time	6000	ms		○		
PF65	DLY1	Inner position 1 completion delay time	0	ms		○		
PF66	DLY2	Inner position 2 completion delay time	100	ms		○		
PF67	DLY3	Inner position 3 completion delay time	200	ms		○		
PF68	DLY4	Inner position 4 completion delay time	300	ms		○		

PF69	DLY5	Inner position 5 completion delay time	500	ms		○		
PF70	DLY6	Inner position 6 completion delay time	600	ms		○		
PF71	DLY7	Inner position 7 completion delay time	800	ms		○		
PF72	DLY8	Inner position 8 completion delay time	1000	ms		○		
PF73	DLY9	Inner position 9 completion delay time	1200	ms		○		
PF74	DLY10	Inner position 10 completion delay time	1600	ms		○		
PF75	DLY11	Inner position 11 completion delay time	2000	ms		○		
PF76	DLY12	Inner position 12 completion delay time	2500	ms		○		
PF77	DLY13	Inner position 13 completion delay time	3000	ms		○		
PF78	DLY14	Inner position 14 completion delay time	4000	ms		○		
PF79	DLY15	Inner position 15 completion delay time	5000	ms		○		
PF80	DLY16	Inner position 16 completion delay time	6000	ms		○		
PF81	PDEC	Protection trigger deceleration time	0000h	ms		○		
PF82(■)	PRCM	PR trigger register	0	-		○		
PF83	EVON	Event raising trigger	0000h	-		○		
PF84	EVOF	Event falling trigger	0000h	-		○		
PF85(■)	PMEM	PATH#1 to PATH#2 memory invalid	0000h	-		○		
PF86	SWLP	Software forward stroke limit	$2^{31}-1$	-		○		
PF87	SWLN	Software reverse stroke limit	$-2^{31}+1$	-		○		
PF88	KNBR	Tool quantity of turret	0	-		○		
PF89~PF90	Reserved							

Some parameter categories which are helpful to operate varied control mode are listed below.

Torque control related parameters								
NO	Abbr.	Name	Default	Unit	Control mode			
					Pt	Pr	S	T
PA01(★)	STY	Control mode option	1000h	-	<input type="radio"/>	<input type="radio"/>	<input type="radio"/>	<input type="radio"/>
PA05	TL1	Inner torque limit 1	100	%	<input type="radio"/>	<input type="radio"/>	<input type="radio"/>	<input type="radio"/>
PC05	SC1	Inner speed command/limit 1	100	rpm			<input type="radio"/>	<input type="radio"/>
PC06	SC2	Inner speed command/limit 2	500	rpm			<input type="radio"/>	<input type="radio"/>
PC07	SC3	Inner speed command/limit 3	1000	rpm			<input type="radio"/>	<input type="radio"/>
PC08	SC4	Inner speed command/limit 4	200	rpm			<input type="radio"/>	<input type="radio"/>
PC09	SC5	Inner speed command/limit 5	300	rpm			<input type="radio"/>	<input type="radio"/>
PC10	SC6	Inner speed command/limit 6	500	rpm			<input type="radio"/>	<input type="radio"/>
PC11	SC7	Inner speed command/limit 7	800	rpm			<input type="radio"/>	<input type="radio"/>
PC12(▲)	VCM	Output speed of maximum analog command	3000	rpm			<input type="radio"/>	<input type="radio"/>
PC13(▲)	TLC	Torque generated of maximum analog command	100	%	<input type="radio"/>	<input type="radio"/>	<input type="radio"/>	<input type="radio"/>
PC25	TL2	Inner torque limit 2	100	%	<input type="radio"/>	<input type="radio"/>	<input type="radio"/>	<input type="radio"/>
PC26	VCO	Speed analog command/limit offset	0	mV			<input type="radio"/>	<input type="radio"/>
PC27	TLO	Torque analog command/limit offset	0	mV			<input type="radio"/>	<input type="radio"/>
PC35(★)	VCL	VC input voltage limit	0	mV			<input type="radio"/>	<input type="radio"/>

Speed control related parameters								
NO	Abbr.	Name	Default	Unit	Control mode			
					Pt	Pr	S	T
PA01(★)	STY	Control mode option	1000h	-	<input type="radio"/>	<input type="radio"/>	<input type="radio"/>	<input type="radio"/>
PA05	TL1	Inner torque limit 1	100	%	<input type="radio"/>	<input type="radio"/>	<input type="radio"/>	<input type="radio"/>
PA14(★)	ENR	Encoder output pulses	10000	pulse/rev	<input type="radio"/>	<input type="radio"/>	<input type="radio"/>	<input type="radio"/>
PB18	SFLT	Speed low-pass filter smooth time constant	0	ms			<input type="radio"/>	<input type="radio"/>
PC05	SC1	Inner speed command/limit 1	100	rpm			<input type="radio"/>	<input type="radio"/>
PC06	SC2	Inner speed command/limit 2	500	rpm			<input type="radio"/>	<input type="radio"/>
PC07	SC3	Inner speed command/limit 3	1000	rpm			<input type="radio"/>	<input type="radio"/>
PC08	SC4	Inner speed command/limit 4	200	rpm			<input type="radio"/>	<input type="radio"/>
PC09	SC5	Inner speed command/limit 5	300	rpm			<input type="radio"/>	<input type="radio"/>
PC10	SC6	Inner speed command/limit 6	500	rpm			<input type="radio"/>	<input type="radio"/>
PC11	SC7	Inner speed command/limit 7	800	rpm			<input type="radio"/>	<input type="radio"/>
PC12(▲)	VCM	Output speed of maximum analog command	3000	rpm			<input type="radio"/>	<input type="radio"/>
PC25	TL2	Inner torque limit 2	100	%	<input type="radio"/>	<input type="radio"/>	<input type="radio"/>	<input type="radio"/>
PC26	VCO	Speed analog command/limit offset	0	mV			<input type="radio"/>	<input type="radio"/>
PC35	VCL	VC input voltage limit	0	mV			<input type="radio"/>	<input type="radio"/>



Position control related parameters								
NO	Abbr.	Name	Default	Unit	Control mode			
					Pt	Pr	S	T
PA01(★)	STY	Control mode option	1000h	-	<input type="radio"/>	<input type="radio"/>	<input type="radio"/>	<input type="radio"/>
PA04	HMOV	Home moving option	0000h	-	<input type="checkbox"/>	<input type="radio"/>	<input type="checkbox"/>	<input type="checkbox"/>
PA05	TL1	Inner torque limit 1	100	%	<input type="radio"/>	<input type="radio"/>	<input type="radio"/>	<input type="radio"/>
PA06	CMX	Electronic gear numerator	1	-	<input type="radio"/>	<input type="radio"/>	<input type="checkbox"/>	<input type="checkbox"/>
PA07(▲)	CDV	Electronic gear denominator	1	-	<input type="radio"/>	<input type="radio"/>	<input type="checkbox"/>	<input type="checkbox"/>
PA13(★)	PLSS	Command pulse option	0000h	-	<input type="radio"/>	<input type="checkbox"/>	<input type="checkbox"/>	<input type="checkbox"/>
PA14(★)	ENR	Encoder output pulses	10000	pulse/rev	<input type="radio"/>	<input type="radio"/>	<input type="radio"/>	<input type="radio"/>
PA15	PO1H	Revolution of inner position command 1	0	rev	<input type="checkbox"/>	<input type="radio"/>	<input type="checkbox"/>	<input type="checkbox"/>
PA39(★)	POL	Motor rotary direction option	0000h	-	<input type="radio"/>	<input type="radio"/>	<input type="radio"/>	<input type="radio"/>
PC25	TL2	Inner torque limit 2	100	%	<input type="radio"/>	<input type="radio"/>	<input type="radio"/>	<input type="radio"/>
PC32	CMX2	Electronic gear numerator 2	1	-	<input type="radio"/>	<input type="radio"/>	<input type="checkbox"/>	<input type="checkbox"/>
PC33	CMX3	Electronic gear numerator 3	1	-	<input type="radio"/>	<input type="radio"/>	<input type="checkbox"/>	<input type="checkbox"/>
PC34	CMX4	Electronic gear numerator 4	1	-	<input type="radio"/>	<input type="radio"/>	<input type="checkbox"/>	<input type="checkbox"/>
PE01	ODEF	Origin return definition	0000h	-	<input type="checkbox"/>	<input type="radio"/>	<input type="checkbox"/>	<input type="checkbox"/>
PE02	ODAT	Origin offset value definition	0	-	<input type="checkbox"/>	<input type="radio"/>	<input type="checkbox"/>	<input type="checkbox"/>
PE03~PE98		Pr stroke related parameters			<input type="radio"/>	<input type="radio"/>	<input type="checkbox"/>	<input type="checkbox"/>
PF01~PF87		Pr stroke related parameters			<input type="radio"/>	<input type="radio"/>	<input type="checkbox"/>	<input type="checkbox"/>

Smoothing filter and resonance suppression related parameters								
NO	Abbr.	Name	Default	Unit	Control mode			
					Pt	Pr	S	T
PB01	NHF1	Machine resonance suppression filter 1	1000	Hz	<input type="radio"/>	<input type="radio"/>	<input type="radio"/>	<input type="radio"/>
PB02	NHD1	Machine resonance suppression attenuation 1	0	dB	<input type="radio"/>	<input type="radio"/>	<input type="radio"/>	<input type="radio"/>
PB03	NLP	Resonance suppression low-pass filter	0	0.1mS	<input type="radio"/>	<input type="radio"/>	<input type="radio"/>	<input type="radio"/>
PB04	PST	Position command filter time constant	3	Ms	<input type="radio"/>	<input type="radio"/>	<input type="checkbox"/>	<input type="checkbox"/>
PB19	TQC	Torque command filter time constant	0	ms	<input type="checkbox"/>	<input type="checkbox"/>	<input type="checkbox"/>	<input type="radio"/>
PB20	SJIT	Speed feedback filter time constant	0	0.1mS	<input type="radio"/>	<input type="radio"/>	<input type="radio"/>	<input type="radio"/>
PB21	NHF2	Machine resonance suppression filter 2	1000	Hz	<input type="radio"/>	<input type="radio"/>	<input type="radio"/>	<input type="radio"/>
PB22	NHD2	Machine resonance suppression attenuation 2	0	dB	<input type="radio"/>	<input type="radio"/>	<input type="radio"/>	<input type="radio"/>
PB23(★)	MVS	Micro-vibration suppression option	0000h	-	<input type="radio"/>	<input type="radio"/>	<input type="checkbox"/>	<input type="checkbox"/>
PB25	NHF3	Machine resonance suppression filter 3	1000	Hz	<input type="radio"/>	<input type="radio"/>	<input type="radio"/>	<input type="radio"/>
PB26	NHD3	Machine resonance suppression attenuation 3	0	dB	<input type="radio"/>	<input type="radio"/>	<input type="radio"/>	<input type="radio"/>
PB27	ANCF	Auto resonance suppression mode	1	-	<input type="radio"/>	<input type="radio"/>	<input type="radio"/>	<input type="radio"/>
PB28	ANCL	Resonance suppression detection level	50	%	<input type="radio"/>	<input type="radio"/>	<input type="radio"/>	<input type="radio"/>
PB29	AVSM	Auto vibration suppression mode	0	-	<input type="radio"/>	<input type="radio"/>	<input type="checkbox"/>	<input type="checkbox"/>

PB30	VCL	Low-frequency vibration detection level	50	pulse	<input type="radio"/>	<input type="radio"/>		
PB31	VSF1	Vibration suppression frequency 1	100	0.1Hz	<input type="radio"/>	<input type="radio"/>		
PB32	VSG1	Vibration suppression gain 1	0	-	<input type="radio"/>	<input type="radio"/>		
PB33	VSF2	Vibration suppression frequency 2	100	0.1Hz	<input type="radio"/>	<input type="radio"/>		
PB34	VSG2	Vibration suppression gain 2	0	-	<input type="radio"/>	<input type="radio"/>		
PB35	FRCL	Friction compensation level	0	%	<input type="radio"/>	<input type="radio"/>	<input type="radio"/>	
PB36	FRCT	Friction compensation filter time constant	0	ms	<input type="radio"/>	<input type="radio"/>	<input type="radio"/>	
PB37	FRCM	Friction compensation option	0	-	<input type="radio"/>	<input type="radio"/>	<input type="radio"/>	
PB38	FFCT	Position feed forward filter time constant	0	ms	<input type="radio"/>	<input type="radio"/>		
PC01	STA	Acceleration time constant	200	Ms		<input type="radio"/>	<input type="radio"/>	<input type="radio"/>
PC02	STB	Deceleration time constant	200	Ms		<input type="radio"/>	<input type="radio"/>	<input type="radio"/>
PC03	STC	S-pattern acc./dec. time constant	0	ms		<input type="radio"/>	<input type="radio"/>	<input type="radio"/>
PD17(★)	DOP1	LSP/LSN triggered stop option	0000h	-	<input type="radio"/>	<input type="radio"/>	<input type="radio"/>	

Control gain and gain switch related parameters								
NO	Abbr.	Name	Default	Unit	Control mode			
					Pt	Pr	S	T
PA02(▲)	ATUM	Gain tuning mode option	0002h	-	<input type="radio"/>	<input type="radio"/>	<input type="radio"/>	
PA03	ATUL	Auto-tuning response level setting	0005h	-	<input type="radio"/>	<input type="radio"/>	<input type="radio"/>	
PB05	FFC	Position feed-forward gain	0	0.0001	<input type="radio"/>	<input type="radio"/>		
PB07	PG1	Position loop gain	35	rad/s	<input type="radio"/>	<input type="radio"/>		
PB08	VG1	Speed loop gain	817	rad/s	<input type="radio"/>	<input type="radio"/>	<input type="radio"/>	
PB09	VIC	Speed integral gain	48	ms	<input type="radio"/>	<input type="radio"/>	<input type="radio"/>	
PB10	VFG	Speed feed-forward gain	0	0.0001			<input type="radio"/>	
PB11(★)	CDP	Gain switch condition	0000h	-	<input type="radio"/>	<input type="radio"/>	<input type="radio"/>	
PB12	CDS	Gain switch condition value	10	depends	<input type="radio"/>	<input type="radio"/>	<input type="radio"/>	
PB13	CDT	Gain switch time constant	1	ms	<input type="radio"/>	<input type="radio"/>	<input type="radio"/>	
PB14	GD2	The ratio 2 of load inertia to motor shaft	70	0.1time	<input type="radio"/>	<input type="radio"/>	<input type="radio"/>	
PB15	PG2	Position loop gain change ratio	100	%	<input type="radio"/>	<input type="radio"/>	<input type="radio"/>	
PB16	VG2	Speed loop gain change ratio	100	%	<input type="radio"/>	<input type="radio"/>	<input type="radio"/>	
PB17	VIC2	Speed integral gain change ratio	100	%	<input type="radio"/>	<input type="radio"/>	<input type="radio"/>	
PB24	VDC	Speed differential compensation	980	-	<input type="radio"/>	<input type="radio"/>	<input type="radio"/>	

Digital I/O settings related parameters								
NO	Abbr.	Name	Default	Unit	Control mode			
					Pt	Pr	S	T
PA12	INP	In-position range	100	Pulse	<input type="radio"/>	<input type="radio"/>		
PC16	MBR	Electromagnetic brake output delay time	100	ms	<input type="radio"/>	<input type="radio"/>	<input type="radio"/>	<input type="radio"/>
PC17	ZSP	Zero speed acknowledged range	50	rpm	<input type="radio"/>	<input type="radio"/>	<input type="radio"/>	<input type="radio"/>
PD01(★)	DIA1	Digital input signal auto-ON option 1	0000h	-	<input type="radio"/>	<input type="radio"/>	<input type="radio"/>	<input type="radio"/>
PD02(★)	DI1	Digital input 1 option(CN1-14)	0001h	-	<input type="radio"/>	<input type="radio"/>	<input type="radio"/>	<input type="radio"/>
PD03(★)	DI2	Digital input 2 option(CN1-15)	000Dh	-	<input type="radio"/>	<input type="radio"/>	<input type="radio"/>	<input type="radio"/>
PD04(★)	DI3	Digital input 3 option(CN1-16)	0003h	-	<input type="radio"/>	<input type="radio"/>	<input type="radio"/>	<input type="radio"/>
PD05(★)	DI4	Digital input 4 option(CN1-17)	0004h	-	<input type="radio"/>	<input type="radio"/>	<input type="radio"/>	<input type="radio"/>
PD06(★)	DI5	Digital input 5 option(CN1-18)	0002h	-	<input type="radio"/>	<input type="radio"/>	<input type="radio"/>	<input type="radio"/>
PD07(★)	DI6	Digital input 6 option(CN1-19)	000Fh	-	<input type="radio"/>	<input type="radio"/>	<input type="radio"/>	<input type="radio"/>
PD08(★)	DI7	Digital input 7 option(CN1-20)	0012h	-	<input type="radio"/>	<input type="radio"/>	<input type="radio"/>	<input type="radio"/>
PD09(★)	DI8	Digital input 8 option(CN1-21)	0011h	-	<input type="radio"/>	<input type="radio"/>	<input type="radio"/>	<input type="radio"/>
PD10(★)	DO1	Digital output 1 option(CN1-41)	0003h	-	<input type="radio"/>	<input type="radio"/>	<input type="radio"/>	<input type="radio"/>
PD11(★)	DO2	Digital output 2 option(CN1-42)	0008h	-	<input type="radio"/>	<input type="radio"/>	<input type="radio"/>	<input type="radio"/>
PD12(★)	DO3	Digital output 3 option(CN1-43)	0007h	-	<input type="radio"/>	<input type="radio"/>	<input type="radio"/>	<input type="radio"/>
PD13(★)	DO4	Digital output 4 option(CN1-44)	0005h	-	<input type="radio"/>	<input type="radio"/>	<input type="radio"/>	<input type="radio"/>
PD14(★)	DO5	Digital output 5 option(CN1-45)	0001h	-	<input type="radio"/>	<input type="radio"/>	<input type="radio"/>	<input type="radio"/>
PD15(★)	DIF	Digital input filter time option	0002h	-	<input type="radio"/>	<input type="radio"/>	<input type="radio"/>	<input type="radio"/>
PD16(★)	IOS	Digital input on/off control source option	0000h	-	<input type="radio"/>	<input type="radio"/>	<input type="radio"/>	<input type="radio"/>
PD17(★)	DOP1	LSP/LSN triggered stop option	0000h	-	<input type="radio"/>	<input type="radio"/>	<input type="radio"/>	
PD18(★)	DOP2	CR signal clear option	0000h	-	<input type="radio"/>	<input type="radio"/>		
PD19(★)	DOP3	Alarm code output option	0000h	-	<input type="radio"/>	<input type="radio"/>	<input type="radio"/>	<input type="radio"/>
PD20(★)	DOP4	Alarm reset triggered process	0000h	-	<input type="radio"/>	<input type="radio"/>	<input type="radio"/>	<input type="radio"/>
PD21(★)	DIA2	Digital input signal auto-ON option 2	0000h	-	<input type="radio"/>	<input type="radio"/>	<input type="radio"/>	<input type="radio"/>
PD22(★)	DI10	Digital input 10 option	0000h	-	<input type="radio"/>	<input type="radio"/>	<input type="radio"/>	<input type="radio"/>
PD23(★)	DI11	Digital input 11 option	0000h	-	<input type="radio"/>	<input type="radio"/>	<input type="radio"/>	<input type="radio"/>
PD24(★)	DI12	Digital input 12 option	0000h	-	<input type="radio"/>	<input type="radio"/>	<input type="radio"/>	<input type="radio"/>
PD25(■)	ITST	Communication control DI on/off	0000h	-	<input type="radio"/>	<input type="radio"/>	<input type="radio"/>	<input type="radio"/>
PD26(★)	DO6	Digital output 6 option	0002h	-	<input type="radio"/>	<input type="radio"/>	<input type="radio"/>	<input type="radio"/>
PD27(★)	DOD	DO signal contact definition	0000h	-	<input type="radio"/>	<input type="radio"/>	<input type="radio"/>	<input type="radio"/>
PD28	MCOK	Motion completion option	0000h	-		<input type="radio"/>		
PD29(★)	DID	DI signal contact definition	0000h	-	<input type="radio"/>	<input type="radio"/>	<input type="radio"/>	<input type="radio"/>

Communication related parameters								
NO	Abbr.	Name	Default	Unit	Control mode			
					Pt	Pr	S	T
PC20(★)	SNO	Communication device number	1	-	<input type="radio"/>	<input type="radio"/>	<input type="radio"/>	<input type="radio"/>
PC21(★)	CMS	Communication mode option	0010h	-	<input type="radio"/>	<input type="radio"/>	<input type="radio"/>	<input type="radio"/>
PC22(★)	BPS	Communication protocol option	0010h	-	<input type="radio"/>	<input type="radio"/>	<input type="radio"/>	<input type="radio"/>
PC23	SIC	Communication time-out process option	0	S	<input type="radio"/>	<input type="radio"/>	<input type="radio"/>	<input type="radio"/>







Monitor and status display related parameters								
NO	Abbr.	Name	Default	Unit	Control mode			
					Pt	Pr	S	T
PC14	MOD	Analog monitor output	0100h	-	<input type="radio"/>	<input type="radio"/>	<input type="radio"/>	<input type="radio"/>
PC24(★)	DMD	Status display option	0000h	-	<input type="radio"/>	<input type="radio"/>	<input type="radio"/>	<input type="radio"/>
PC28	MO1	Analog monitor ch1 offset	0	mV	<input type="radio"/>	<input type="radio"/>	<input type="radio"/>	<input type="radio"/>
PC29	MO2	Analog monitor ch2 offset	0	mV	<input type="radio"/>	<input type="radio"/>	<input type="radio"/>	<input type="radio"/>
PC30	MOG1	Analog monitor ch1 output proportion	100	%	<input type="radio"/>	<input type="radio"/>	<input type="radio"/>	<input type="radio"/>
PC31	MOG2	Analog monitor ch2 output proportion	100	%	<input type="radio"/>	<input type="radio"/>	<input type="radio"/>	<input type="radio"/>

Other functions related parameters								
NO	Abbr.	Name	Default	Unit	Control mode			
					Pt	Pr	S	T
PA40(▲)	SPW	Special parameter write-enable	0000h	-	<input type="radio"/>	<input type="radio"/>	<input type="radio"/>	<input type="radio"/>
PA42(★)	BLK	Parameter write-inhibit	0000h	-	<input type="radio"/>	<input type="radio"/>	<input type="radio"/>	<input type="radio"/>
PB06	GD1	Load to motor inertia ratio	10	0.1time	<input type="radio"/>	<input type="radio"/>	<input type="radio"/>	
PB14	GD2	The ratio 2 of load inertia to motor shaft	70	0.1time	<input type="radio"/>	<input type="radio"/>	<input type="radio"/>	
PC18(★)	COP1	Stop option and power interruption restart option	0010h	-	<input type="radio"/>	<input type="radio"/>	<input type="radio"/>	<input type="radio"/>
PC19(★)	COP2	Alarm history clear option	0000h	-	<input type="radio"/>	<input type="radio"/>	<input type="radio"/>	<input type="radio"/>
PC36	BRP	Built-in brake resistor protection	300	ms	<input type="radio"/>	<input type="radio"/>	<input type="radio"/>	<input type="radio"/>
PC37(■)	MCS	Memory write-in protection	0	-	<input type="radio"/>	<input type="radio"/>	<input type="radio"/>	<input type="radio"/>
PD20(★)	DOP4	Alarm reset triggered process	0000h	-	<input type="radio"/>	<input type="radio"/>	<input type="radio"/>	<input type="radio"/>

### 5.3. Parameter details list

No	Abbr.	Function description	Control mode	Setting range	Unit																																																																														
PA01	STY	Setting value of Control mode option: <table border="1" style="display: inline-table; vertical-align: middle;"> <tr> <td>u</td> <td>z</td> <td>y</td> <td>x</td> </tr> </table> <u>x: control mode select</u> 0: position 1: position/speed 2: speed 3: speed/torque 4: torque 5: torque/position <u>y: position command select</u> 0: external input 1: inner register(absolute type) 2: inner register(incremental type) <u>z: electromagnetic brake enabled option</u> 0: disabled 1: enabled. (Motor with electromagnetic brake applied) <u>u: DI/DO setting option</u> 0: Functions of DI/DO are fixed. 1: Functions of DI/DO are changed as control mode switched.	u	z	y	x	Pt, Pr S,T	0000h ~1125h	-																																																																										
u	z	y	x																																																																																
PA02	ATUM	Gain tuning mode option: <table border="1" style="display: inline-table; vertical-align: middle;"> <tr> <td>0</td> <td>0</td> <td>0</td> <td>x</td> </tr> </table> <u>x: gain tuning mode option</u> 0: manual-gain tuning(PI control) 1: manual-gain tuning(PI control + interference compensator) 2: Auto-gain tuning(load inertia ratio and bandwidth estimated) 3: Auto-gain tuning(fixed load inertia ratio) 4: Interpolation mode(PB37 is fixed, other gain value estimated)	0	0	0	x	Pt, Pr S	0000h ~0004h	-																																																																										
0	0	0	x																																																																																
PA03	ATUL	Auto-tuning response level setting: <table border="1" style="display: inline-table; vertical-align: middle;"> <tr> <td>0</td> <td>0</td> <td>0</td> <td>x</td> </tr> </table> <u>x: response level setting</u> <table border="1" style="width: 100%; text-align: center;"> <thead> <tr> <th>Value</th> <th>Rigidity</th> <th>Response frequency</th> <th>Value</th> <th>Rigidity</th> <th>Response frequency</th> </tr> </thead> <tbody> <tr><td>1</td><td rowspan="15" style="vertical-align: middle;">↑ Low</td><td>10.0Hz</td><td>17</td><td rowspan="15" style="vertical-align: middle;">↑ Middle</td><td>67.1Hz</td></tr> <tr><td>2</td><td>11.3Hz</td><td>18</td><td>75.6Hz</td></tr> <tr><td>3</td><td>12.7Hz</td><td>19</td><td>85.2Hz</td></tr> <tr><td>4</td><td>14.3Hz</td><td>20</td><td>95.9Hz</td></tr> <tr><td>5</td><td>16.1Hz</td><td>21</td><td>108.0Hz</td></tr> <tr><td>6</td><td>18.1Hz</td><td>22</td><td>121.7Hz</td></tr> <tr><td>7</td><td>20.4Hz</td><td>23</td><td>137.1Hz</td></tr> <tr><td>8</td><td>23.0Hz</td><td>24</td><td>154.4Hz</td></tr> <tr><td>9</td><td>25.9Hz</td><td>25</td><td>173.9Hz</td></tr> <tr><td>10</td><td>29.2Hz</td><td>26</td><td>195.9Hz</td></tr> <tr><td>11</td><td>32.9Hz</td><td>27</td><td>220.6Hz</td></tr> <tr><td>12</td><td>37.0Hz</td><td>28</td><td>248.5Hz</td></tr> <tr><td>13</td><td>41.7Hz</td><td>29</td><td>279.9Hz</td></tr> <tr><td>14</td><td>47.0Hz</td><td>30</td><td>315.3Hz</td></tr> <tr><td>15</td><td>52.9Hz</td><td>31</td><td>355.1Hz</td></tr> <tr><td>16</td><td style="vertical-align: middle;">↓ Middle</td><td>59.6Hz</td><td>32</td><td style="vertical-align: middle;">↓ High</td><td>400.0Hz</td></tr> </tbody> </table>	0	0	0	x	Value	Rigidity	Response frequency	Value	Rigidity	Response frequency	1	↑ Low	10.0Hz	17	↑ Middle	67.1Hz	2	11.3Hz	18	75.6Hz	3	12.7Hz	19	85.2Hz	4	14.3Hz	20	95.9Hz	5	16.1Hz	21	108.0Hz	6	18.1Hz	22	121.7Hz	7	20.4Hz	23	137.1Hz	8	23.0Hz	24	154.4Hz	9	25.9Hz	25	173.9Hz	10	29.2Hz	26	195.9Hz	11	32.9Hz	27	220.6Hz	12	37.0Hz	28	248.5Hz	13	41.7Hz	29	279.9Hz	14	47.0Hz	30	315.3Hz	15	52.9Hz	31	355.1Hz	16	↓ Middle	59.6Hz	32	↓ High	400.0Hz	Pt, Pr S,T	1 ~32	-
0	0	0	x																																																																																
Value	Rigidity	Response frequency	Value	Rigidity	Response frequency																																																																														
1	↑ Low	10.0Hz	17	↑ Middle	67.1Hz																																																																														
2		11.3Hz	18		75.6Hz																																																																														
3		12.7Hz	19		85.2Hz																																																																														
4		14.3Hz	20		95.9Hz																																																																														
5		16.1Hz	21		108.0Hz																																																																														
6		18.1Hz	22		121.7Hz																																																																														
7		20.4Hz	23		137.1Hz																																																																														
8		23.0Hz	24		154.4Hz																																																																														
9		25.9Hz	25		173.9Hz																																																																														
10		29.2Hz	26		195.9Hz																																																																														
11		32.9Hz	27		220.6Hz																																																																														
12		37.0Hz	28		248.5Hz																																																																														
13		41.7Hz	29		279.9Hz																																																																														
14		47.0Hz	30		315.3Hz																																																																														
15		52.9Hz	31		355.1Hz																																																																														
16	↓ Middle	59.6Hz	32	↓ High	400.0Hz																																																																														

No	Abbr.	Function description	Control mode	Setting range	Unit												
PA04	HMOV	<p>Home moving option:</p> <table border="1"> <tr> <td>0</td> <td>z</td> <td>y</td> <td>x</td> </tr> </table> <p><u>x: origin detector and rotation option</u>  0: Running in CCW rotation and LSP is as a trigger  1: Running in CW rotation and LSN is as a trigger  2: Running in CCW rotation and ORGP ↑ is as a trigger  3: Running in CW rotation and ORGP ↑ is as a trigger  4: Running in CCW rotation and Encoder Z pulse as a trigger  5: Running in CW rotation and Encoder Z pulse as a trigger  6: Running in CCW rotation and ORGP ↓ is as a trigger  7: Running in CW rotation and ORGP ↓ is as a trigger  8: Current position as a origin</p> <p><u>y: origin attained shortcut moving option</u>  0: motor turns back to last Z pulse to attain  1: motor goes ahead to next Z pulse to attain  2: origin recognized right away</p> <p><u>z: origin recognized completion option</u>  0: motor decelerates to stop then return to the mechanism origin  1: motor decelerates to stop</p>	0	z	y	x	Pr	0000h ~0128h	-								
0	z	y	x														
PA05	TL1	<p>Inner torque limit 1:  Motor generated torque is restricted by this parameter which unit is %. The generated torque is calculated as below.  <i>Torque limit value = maximum torque * PA05</i>  TL signal is used to select PA05 or analog TLA as limit value.  TL1 signal enables the PC25 to compare with PA05 or TLA.  If the TL1 and SG are open-circuit, the valid torque limit is:</p> <table border="1"> <thead> <tr> <th>TL-SG</th> <th>The valid torque limit</th> </tr> </thead> <tbody> <tr> <td>open-circuit</td> <td>PA05</td> </tr> <tr> <td>short-circuit</td> <td>If TLA &lt; PA05, limit value=TLA If TLA &gt; PA05, limit value=PA05</td> </tr> </tbody> </table> <p>If the TL1 and SG are short-circuit, the valid torque limit is:</p> <table border="1"> <thead> <tr> <th>TL-SG</th> <th>The valid torque limit</th> </tr> </thead> <tbody> <tr> <td>open-circuit</td> <td>If PC25 &lt; PA05, limit value=PC25 If PC25 &gt; PA05, limit value=PA05</td> </tr> <tr> <td>short-circuit</td> <td>If PC25 &lt; TLA, limit value=PC25 If PC25 &gt; TLA, limit value=TLA</td> </tr> </tbody> </table>	TL-SG	The valid torque limit	open-circuit	PA05	short-circuit	If TLA < PA05, limit value=TLA If TLA > PA05, limit value=PA05	TL-SG	The valid torque limit	open-circuit	If PC25 < PA05, limit value=PC25 If PC25 > PA05, limit value=PA05	short-circuit	If PC25 < TLA, limit value=PC25 If PC25 > TLA, limit value=TLA	Pt, Pr S	0000h ~0003h	-
TL-SG	The valid torque limit																
open-circuit	PA05																
short-circuit	If TLA < PA05, limit value=TLA If TLA > PA05, limit value=PA05																
TL-SG	The valid torque limit																
open-circuit	If PC25 < PA05, limit value=PC25 If PC25 > PA05, limit value=PA05																
short-circuit	If PC25 < TLA, limit value=PC25 If PC25 > TLA, limit value=TLA																
PA06	CMX	<p>Electronic gear numerator  See section 6.4.4 for more details.</p>	Pt, Pr	1 ~32767	-												
PA07	CDV	<p>Electronic gear denominator  The improper setting could lead to unexpected fast rotation so make sure to set them in the state of SERVO OFF.  The proper range setting is:</p> $\frac{1}{50} \leq \frac{CMX}{CDV} (\text{electronic gear ratio}) \leq 200$	Pt, Pr	1 ~32767	-												

No	Abbr.	Function description	Control mode	Setting range	Unit														
PA08	HSPD1	Home moving high speed option 1 As home moving action is triggered, motor runs at the PA08 speed to search the origin. See section 13.2 for more details.	Pr	1 ~2000	rpm														
PA09	HSPD2	Home moving high speed option 2 As the origin is acknowledged, motor would keep running or turns back at the PA09 speed to search the Z phase pulse. See section 13.2 for more details.	Pr	1 ~500	rpm														
PA10	RES1	Regenerative resistor value <table border="1" data-bbox="443 651 1050 808"> <thead> <tr> <th>Drive capacity</th> <th>Default</th> </tr> </thead> <tbody> <tr> <td>500W below</td> <td>100Ω</td> </tr> <tr> <td>750W~1KW</td> <td>40Ω</td> </tr> <tr> <td>1.5KW~3.5KW</td> <td>13Ω</td> </tr> </tbody> </table>	Drive capacity	Default	500W below	100Ω	750W~1KW	40Ω	1.5KW~3.5KW	13Ω	Pr	10 ~750	ohm						
Drive capacity	Default																		
500W below	100Ω																		
750W~1KW	40Ω																		
1.5KW~3.5KW	13Ω																		
PA11	RES2	Regenerative resistor capacity <table border="1" data-bbox="443 842 1050 999"> <thead> <tr> <th>Drive capacity</th> <th>Default</th> </tr> </thead> <tbody> <tr> <td>500W below</td> <td>20W</td> </tr> <tr> <td>750W~1KW</td> <td>40W</td> </tr> <tr> <td>1.5KW~3.5KW</td> <td>100W</td> </tr> </tbody> </table>	Drive capacity	Default	500W below	20W	750W~1KW	40W	1.5KW~3.5KW	100W	Pr	0 ~3000	watt						
Drive capacity	Default																		
500W below	20W																		
750W~1KW	40W																		
1.5KW~3.5KW	100W																		
PA12	INP	In-position range To define the permissible pulse error range of position pulse commands. As positioning operation done, the INP signal of DO would output.	Pt, Pr	0 ~2 <sup>22</sup>	pulse														
PA13	PLSS	Setting value of Control mode option: <table border="1" data-bbox="392 1189 571 1223"> <tr> <td>0</td> <td>z</td> <td>y</td> <td>x</td> </tr> </table> <p><u>x: pulse-train format select</u>  0: forward/reverse rotation pulse train  1: pulse train + sign  2: A/B phase pulse train</p> <p><u>y: acknowledged logic</u>  0: positive logic  1: negative logic</p> <p>Here is an example.</p> <table border="1" data-bbox="368 1525 1118 1749"> <thead> <tr> <th colspan="2">Pulse format</th> <th>Forward</th> <th>Reverse</th> </tr> </thead> <tbody> <tr> <td rowspan="2">y=0</td> <td rowspan="2">x=0</td> <td>PP</td> <td></td> </tr> <tr> <td>NP</td> <td></td> </tr> </tbody> </table> <p><u>z: input pulse filter option</u>  0: Pulse frequency 500kpps or less  1: Pulse frequency 200kpps or less  2: Pulse frequency 2Mpps or less  3: Pulse frequency 4Mpps or less</p>	0	z	y	x	Pulse format		Forward	Reverse	y=0	x=0	PP		NP		Pt	0000h ~0312h	-
0	z	y	x																
Pulse format		Forward	Reverse																
y=0	x=0	PP																	
		NP																	

No	Abbr.	Function description	Control mode	Setting range	Unit
PA14	ENR	<p>Encoder output pulses</p> <p>Used to set the A/B-phase pulses encoder output. Users could set the PA39 to choose the output pulse setting or output division ratio. Set the value 4 times greater than the A-phase or B-phase pulses. The number of A/B-phase pulses actual output is 1/4 times. The maximum output frequency is 20MHz. (after multiplication by 4). Use this parameter within this range.</p> <p>For output pulse setting Set " □0□□ " in the PA39, then set PA14 to decide the number of pulses per servo motor revolution. If PA39=0000h and PA14=1024, the actual output pulses per motor revolution is 1024.</p> <p>For output division ratio setting Set " □1□□ " in parameter PA39. Set the output division ratio(PA14) per motor revolution.</p> $\text{Output pulses} = \frac{\text{Resolution per motor revolution}}{\text{PA14 setting value}}$ <p>If PA39=0100h and PA14=512, the actual output pulses per motor revolution is <math>(2^{22}/512)=8192</math>.</p>	Pt, Pr S,T	4 ~2 <sup>22</sup>	pulse/rev
PA15	CRSHA	<p>Motor crash protection level</p> <p>To prevent the motor running from crashing the mechanism. If PA15 is 0, the function is disabled. Any non-zero value setting will enable this function.</p>	Pr, PT S,T	0 ~300	%
PA16	CRSHT	<p>Motor crash protection</p> <p>When the PA15 level is reached and the PA16 setting time has taken, then the AL20 will occur.</p>	Pr, PT S,T	0 ~1000	ms
PA17	OVL	<p>Output overload warning level</p> <p>Used to set output overload level. If PA17 setting is within 0 ~ 100, when the motor has reached this level, a warning will be activated. If PA17 setting exceeds 100, the function is disabled.</p>	Pr, PT S,T	0 ~120	%
PA18	OVS	<p>Overspeed warning</p> <p>When the motor feedback speed exceeds this PA18 setting, the AL06 will occur.</p>	Pr, Pt S,T	1 ~6000	rpm
PA19	OVPE	<p>Position error excess</p> <p>When the position error exceeds this PA19 setting, the AL08 will occur.</p>	Pr, Pt	1 ~2 <sup>31</sup> -1	rev
PA20	OVPL1	<p>Position pulse frequency excess level 1</p> <p>When PA13 is set as 0□□□ and the position command pulse frequency exceeds this PA20 setting, the AL07 will occur.</p>	Pt	100 ~5000	KHz



No	Abbr.	Function description	Control mode	Setting range	Unit												
PA21		Reserved															
PA22	DBF	Dynamic brake control Used to enable or disable the dynamic brake if a alarm occurred. 0: DBF enabled, the motor stops immediately. 1: DBF disabled, the motor coasts to stop gradually.	Pr, Pt S,T	0 ~1	-												
PA23	MCS	Memory write-inhibit function Used to permit or prohibit memory-write. 0: EEPROM is writable. 1: EEPROM is prohibited to be written. Parameter modification will vanish after power off.	Pr, Pt S,T	0 ~1	-												
PA24~PA27		Reserved															
PA28	ABS	Absolute encoder settings Used to permit that the motor with absolute encoder but is operated as an incremental motor. 0: Incremental mode. 1: Absolute mode. This setting is only available for the servo motor with absolute encoder, otherwise the AL24 will occur.	Pr, Pt S,T	0000h ~0001h	-												
PA29	CAP	Absolute homing position When the PA29 is set as 1, the current position will be set as origin position. This function is the same as the ABSC.	Pr, Pt S,T	0000h ~0001h	-												
PA30	UAP	Update encoder absolute position Used to update the absolute position data of the encoder. 1: Update the encoder data to PA31~PA33 only 2: Update the PA31~PA33 and clear the position error as well. As this setting is activated, the current position of the motor will be reset as the goal of position command.	Pr, Pt S,T	0 ~2	-												
PA31	APST	Absolute coordinate system state (read only) <table border="1" style="margin-left: 20px;"> <thead> <tr> <th>bit15~bit5</th> <th>bit4</th> <th>bit3</th> <th>bit2</th> <th>bit1</th> <th>bit0</th> </tr> </thead> <tbody> <tr> <td>0</td> <td>0/1</td> <td>0</td> <td>0/1</td> <td>0/1</td> <td>0/1</td> </tr> </tbody> </table> <u>bit0</u> : 0: normal 1: absolute position has lost <u>bit1</u> : 0: normal 1: low voltage <u>bit2</u> : 0: normal 1: overflow <u>bit3</u> : reserved <u>bit4</u> : 0: normal 1: absolute coordinate system has not yet been set bit5~bit15: reserved	bit15~bit5	bit4	bit3	bit2	bit1	bit0	0	0/1	0	0/1	0/1	0/1	Pr, Pt S,T	0000h ~001Fh	rpm
bit15~bit5	bit4	bit3	bit2	bit1	bit0												
0	0/1	0	0/1	0/1	0/1												

No	Abbr.	Function description	Control mode	Setting range	Unit				
PA32	APR	Encoder absolute position (rev) (read only) To display the absolute encoder turn number. This parameter is valid only when the PA28 is set as 1.	Pr, Pt S,T	$2^{17}-1$ ~ $-2^{17}$	rev				
PA33	APP	Encoder absolute position (pulse) (read only) To display the absolute encoder pulse number. This parameter is valid only when the PA28 is set as 1.	Pr, Pt S,T	0 ~ $(2^{22}-1)$	pulse				
PA34	ABSM	I/O communication of absolute system 0: Delta PLC is applied 1: Mitsubishi PLC is applied	Pr, Pt S,T	0 ~1	-				
PA35	FNO1	Function option 1 <table border="1" style="margin-left: 20px;"> <tr> <td>u</td> <td>z</td> <td>y</td> <td>x</td> </tr> </table> <u>x: Torque generated and motor rotary direction</u> When motor run in CCW : 0: the torque regenerated is in CCW 1: the torque regenerated is in CW When motor run in CW : 0 : the torque regenerated is in CW 1 : the torque regenerated is in CCW <u>y: rotary direction definition</u> 0: When ST1 is activated, the motor start to run in CCW. When ST2 is activated, the motor start to run in CW. 1: When ST1 is deactivated, the motor start to run in CCW. When ST1 is activated, the motor start to run in CW. The ST2 signal is invalid, the motor shaft is rotatable. <u>z: servo-lock option</u> 0: servo-lock is valid, the stop position is held. 1: servo-lock is invalid, the stop position is mobile. <u>u: condition of control mode switch</u> 0: ZSP signal is referred when control mode is switched. 1: ZSP signal is not referred when control mode is switched.	u	z	y	x	Pr, Pt S,T	0000h ~1111Fh	-
u	z	y	x						
PA36	FNO2	Function option 2 (In some application, this parameter is enabled. Please do not set it unless the customer is informed by the Shihlin engineers)	Pr, Pt S,T	0000h ~1111Fh	-				
PA37	FNO3	Function option 3 (In some application, this parameter is enabled. Please do not set it unless the customer is informed by the Shihlin engineers)	Pr, Pt S,T	0000h ~1111Fh	-				
PA38		Reserved							

No	Abbr.	Function description	Control mode	Setting range	Unit																																																								
PA39	POL	<p>Motor rotary direction option</p> <p>The relation among motor rotary direction and input command pulse-train direction and encoder output pulse direction is described below.</p> <table border="1" style="margin-left: 20px;"> <tr> <td>0</td> <td>z</td> <td>y</td> <td>x</td> </tr> </table> <p><u>x: input pulse-train and motor rotary direction option</u></p> <table border="1" style="margin-left: 20px;"> <tr> <td rowspan="2">x</td> <td colspan="2">motor rotary direction</td> </tr> <tr> <td>forward pulse-train input</td> <td>reverse pulse-train input</td> </tr> <tr> <td>0</td> <td>CCW</td> <td>CW</td> </tr> <tr> <td>1</td> <td>CW</td> <td>CCW</td> </tr> </table> <p><u>y: motor rotary direction and encoder pulse output option</u></p> <table border="1" style="margin-left: 20px;"> <tr> <td>y</td> <td>motor CCW rotation</td> <td>motor CW rotation</td> </tr> <tr> <td rowspan="2">0</td> <td>A-phase </td> <td>A-phase </td> </tr> <tr> <td>B-phase </td> <td>B-phase </td> </tr> <tr> <td rowspan="2">1</td> <td>A-phase </td> <td>A-phase </td> </tr> <tr> <td>B-phase </td> <td>B-phase </td> </tr> </table> <p><u>z: encoder output option</u></p> <p>0: output pulse 1: output division ratio</p>	0	z	y	x	x	motor rotary direction		forward pulse-train input	reverse pulse-train input	0	CCW	CW	1	CW	CCW	y	motor CCW rotation	motor CW rotation	0	A-phase	A-phase	B-phase	B-phase	1	A-phase	A-phase	B-phase	B-phase	Pr, Pt S,T	0000h ~0111h	-																												
0	z	y	x																																																										
x	motor rotary direction																																																												
	forward pulse-train input	reverse pulse-train input																																																											
0	CCW	CW																																																											
1	CW	CCW																																																											
y	motor CCW rotation	motor CW rotation																																																											
0	A-phase	A-phase																																																											
	B-phase	B-phase																																																											
1	A-phase	A-phase																																																											
	B-phase	B-phase																																																											
PA40	SPW	<p>Special parameter write-enable</p> <p>As this parameter is set as 0088h, the drive would take 2 seconds to recover factory-set. This change is valid by power off once and power on again.</p>	Pr, Pt S,T	0000h ~00FFh	-																																																								
PA41	POSPD	<p>Max. speed output setting of encoder</p> <p>According the actual application, users can set this PA41 to optimize the encoder outputs (LA, LB). If this setting value is exceeded during the motor running, the AL30 will occur. "0" is to disable this function.</p>	Pr, Pt S,T	0 ~6000	rpm																																																								
PA42	BLK	<p>Parameter read/write inhibit option</p> <table border="1" style="margin-left: 20px;"> <tr> <td>PA42</td> <td>PA□□</td> <td>PB□□</td> <td>PC□□</td> <td>PD□□</td> <td>PE□□</td> <td>PF□□</td> </tr> <tr> <td>0000h</td> <td colspan="6" style="text-align: center;">◎</td> </tr> <tr> <td>0001h</td> <td colspan="5" style="text-align: center;">◎</td> <td style="text-align: center;">X</td> </tr> <tr> <td>0002h</td> <td colspan="4" style="text-align: center;">◎</td> <td colspan="2" style="text-align: center;">X</td> </tr> <tr> <td>0003h</td> <td colspan="3" style="text-align: center;">◎</td> <td colspan="3" style="text-align: center;">X</td> </tr> <tr> <td>0004h</td> <td colspan="2" style="text-align: center;">◎</td> <td colspan="4" style="text-align: center;">X</td> </tr> <tr> <td>0005h</td> <td style="text-align: center;">◎</td> <td colspan="5" style="text-align: center;">X</td> </tr> <tr> <td>0006h</td> <td colspan="6" style="text-align: center;">X, but PA42 is excepted it is writable.</td> </tr> </table> <p>◎: R/W enable, ○: R enable W inhibit, X: R/W inhibit</p> <p>Note: When the parameter group is assigned to R/W inhibit, it mean that the display will not show.</p>	PA42	PA□□	PB□□	PC□□	PD□□	PE□□	PF□□	0000h	◎						0001h	◎					X	0002h	◎				X		0003h	◎			X			0004h	◎		X				0005h	◎	X					0006h	X, but PA42 is excepted it is writable.						Pt, Pr S,T	0000h ~0006h	-
PA42	PA□□	PB□□	PC□□	PD□□	PE□□	PF□□																																																							
0000h	◎																																																												
0001h	◎					X																																																							
0002h	◎				X																																																								
0003h	◎			X																																																									
0004h	◎		X																																																										
0005h	◎	X																																																											
0006h	X, but PA42 is excepted it is writable.																																																												

No	Abbr.	Function description	Control mode	Setting range	Unit
PA43	ENB	Encoder resolution This is a read-only parameter.	Pt, Pr S,T	-	-
PA44	EGM	Electronic gear ratio mode 0: normal, ratio=PA06/PA07 1: ratio conversion 1, ratio= encoder resolution/PA45 2: ratio conversion 2, ratio= 2 x PA06/PA07, it is suitable for 22bit to 23bit conversion Here is a explanation diagram :	Pt, Pr	0 ~1	-
		<p>Pt means the encoder resolution per revolution</p>			
PA45	FBP	Position command pulse per revolution Used to set the position command pulse number per revolution when the PA44 is set as 1.	Pt, Pr	$10^3$ ~ $10^6$	pulse
PA46~PA50		Reserved			

No	Abbr.	Function description	Control mode	Setting range	Unit				
PB01	NHF1	Machine resonance suppression filter 1 To set a specific frequency which the controls gain is decreased to suppress the mechanism resonance.	Pt, Pr S,T	10 ~4000	Hz				
PB02	NHD1	Machine resonance suppression attenuation 1 To set the attenuation at the PB01 frequency. The setting of "0" value denotes the disabled of this notch filter.	Pt, Pr S,T	0 ~32	dB				
PB03	NLP	Resonance suppression low-pass filter To set low-pass filter time constant for suppress resonance.	Pt, Pr S,T	0 ~10000	0.1mS				
PB04	PST	Position command filter time constant Used to smooth the running of motor in position control mode. See section 6.4.3 for more details.	Pt, Pr	0 ~20000	ms				
PB05	FFC	Position feed-forward gain To reduce the position error and position settling time, but if the value is set too large, a sudden acceleration or deceleration may cause overshoots.	Pt, Pr	0 ~200	%				
PB06	GD1	The ratio of load inertia to motor shaft (load inertia ratio) See section 5.3.3 for more details.	Pt, Pr S,T	0 ~1200	0.1time				
PB07	PG1	Position loop gain Used to decide response level of position loop. Increasing PG1 improves traceability, but a too high value makes overshooting or vibration occurred.	Pt, Pr	4 ~1024	rad/s				
PB08	VG1	Speed loop gain Increasing VG1 improves traceability to a speed command but a too high value will make machine resonance. It will be set when auto-gain tuning mode is applied.	Pt, Pr S	40 ~9000	rad/s				
PB09	VIC	Speed integral gain Used to eliminate stationary deviation against a command.	Pt, Pr S	1 ~1000	ms				
PB10	VFG	Speed feed-forward gain To set the proper gain would reduce the tracking time of speed command.	Pt, Pr S	0 ~200	%				
PB11	CDP	Gain switch option <table border="1" style="margin-left: 20px;"> <tr> <td>0</td> <td>0</td> <td>0</td> <td>x</td> </tr> </table> <u>x: changing condition</u> 0: Invalid 1: Gain switched as the CDP signal of DI is ON 2: Position command frequency >= PB12 setting 3: Position command pulse error >= PB12 setting 4: Motor speed >= CDS(PB12) setting 5: Gain switched as the CDP signal of DI is OFF 6: Position command frequency <= PB12 setting 7: Position command pulse error <= PB12 setting 8: Motor speed <= PB12 setting	0	0	0	x	Pt, Pr S	0000h ~0008h	-
0	0	0	x						

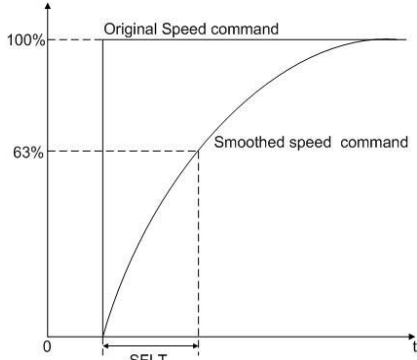
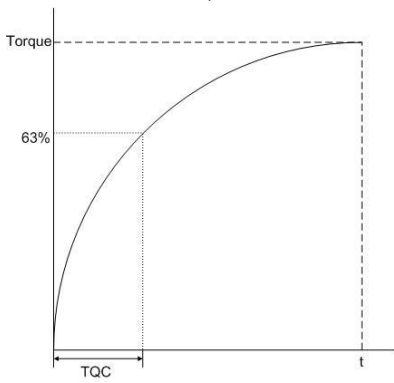
No	Abbr.	Function description	Control mode	Setting range	Unit
PB12	CDS	Gain switch condition value The CDS's unit is varied according to the settings of CDP.	Pt, Pr S	0 ~400000	depends
PB13	CDT	Gain switch time constant Used to smooth the motor running at gain switching moment to suppress vibration if the gain difference is large.	Pt, Pr S	0 ~1000	ms
PB14	GD2	The ratio 2 of load inertia to motor shaft Set the demand ratio of load inertia to motor shaft after switching. This value is valid as gain switch function preformed.	Pt, Pr S	0 ~1200	0.1time
PB15	PG2	Position loop gain change ratio The gain values would be changed as: $gain\ after\ switched = (PG1\ or\ VG1\ or\ VIC) \times PB15(\%)$ These changes are valid only if auto-gain tuning disabled.	Pt, Pr	10 ~500	%
PB16	VG2	Speed loop gain change ratio These changes are valid only if auto-gain tuning disabled.	Pt, Pr S	10 ~500	%
PB17	VIC2	Speed integral gain change ratio These changes are valid only if auto-gain tuning disabled.	Pt, Pr S	10 ~500	%
PB18	SFLT	Speed low-pass filter smooth time constant If it is set as zero, this function is disabled.  The required time to catch the command is 5-time of SELT.	S,T	0 ~1000	ms
PB19	TQC	Torque command filter time constant If it is set as zero, this function is disabled.  The required time to catch the command is 5-time of TQC.	T	0 ~5000	ms

No	Abbr.	Function description	Control mode	Setting range	Unit
PB20	SJIT	Speed feedback filter time constant Used to set the filter time constant of motor speed feedback.	Pt, Pr S,T	0 ~1000	0.1mS
PB21	NHF2	Machine resonance suppression filter 2 The second notch filter frequency to suppress the resonance.	Pt, Pr S,T	10 ~4000	Hz
PB22	NHD2	Machine resonance suppression 2 The second notch filter attenuation option	Pt, Pr S,T	0 ~32	dB
PB23		Reserved			
PB24	VDC	Speed differential compensation This function is valid when the PC signal activated.	Pt, Pr S	0 ~1000	-
PB25	NHF3	Machine resonance suppression filter 3 The third notch filter frequency to suppress the resonance.	Pt, Pr S,T	10 ~4000	Hz
PB26	NHD3	Machine resonance suppression attenuation 3 The third notch filter attenuation option	Pt, Pr S,T	0 ~32	dB
PB27	ANCF	Auto resonance suppression mode (for NHF1 and NHF2) 0: manual set 1: After a auto-scan then the resonance frequency is fixed. 2: Always auto-scan to search the resonance frequency.	Pt, Pr S,T	0 ~2	-
PB28	ANCL	Resonance suppression detection level The high value setting denotes a less sensitivity detection.	Pt, Pr S,T	1 ~300	%
PB29	AVSM	Auto vibration suppression mode 0: manual set 1: After auto-suppression then the vibration frequency is fixed. Note: When users set the PB29 as 1, the servo drive will find the vibration frequency and suppress it, and the frequency will be recorded to PB31, then the PB29 will recover to "0".	Pt, Pr S,T	0 ~1	-
PB30	VCL	Low-frequency vibration detection level The low value setting denotes high sensitivity detection. Users set the proper value to prevent from erroneous detection.	Pt, Pr	1 ~8000	pulse
PB31	VSF1	Vibration suppression frequency 1 To record the manual set or the result of auto-suppression. If PB32 is 0, it denotes the 1 <sup>st</sup> vibration suppression filter is off.	Pt, Pr	1 ~3000	0.1Hz
PB32	VSG1	Vibration suppression gain 1 The high gain setting denotes a high position response. but may cause a cogging motion.	Pt, Pr	0 ~15	-

No	Abbr.	Function description	Control mode	Setting range	Unit
PB33	VSF2	Vibration suppression frequency 2 Used to record the manual set or the result of auto-suppression. If PB34 is 0, it denotes the 2 <sup>nd</sup> vibration suppression filter is off.	Pt, Pr	1 ~3000	0.1Hz
PB34	VSG2	Vibration suppression gain 2 The high gain setting denotes a high position response. but may cause a cogging motion.	Pt, Pr	0 ~15	-
PB35	FRCL	Friction compensation level Used to compensate the friction torque loss. 0 is disable and 1 or above is to enable the friction compensation.	Pt, Pr S	0 ~100	%
PB36	FRCT	Friction compensation filter time constant Used to set the smooth time constant of friction compensation.	Pt, Pr S	0 ~1000	ms
PB37	FRCM	Friction compensation option 0: Compensation is remained if motor speed is less than PC17. 1: Compensation is zero if motor speed is less than PC17.	Pt, Pr S	0 ~1	-
PB38	FFCT	Position feed forward filter time constant Used to set the feed forward filter time constant.	Pt, Pr	0 ~1000	0.1ms
PB39~PB43		Reserved			
PB44	PPD	Position loop differential gain To increase this parameter to improve trackability in response to the position command.	Pt, Pr	0 ~1000	rad/s
PB45~PB48		Reserved			
PB49	DOB	Disturbance observer gain To increase this parameter to decrease the positioning overshoot when the position mode is applied. To increase this parameter to decrease the speed overshoot when the speed mode is applied ※: A high gain adjustment may cause the system resonance.	Pt, Pr S,T	0 ~100	-
PB50		Reserved			



No	Abbr.	Function description	Control mode	Setting range	Unit
PC01	STA	Acceleration time constant This parameter is the time spent for the motor from 0 rpm to the rated speed and it is defined as "acceleration time constant".	Pr S,T	0 ~20000	ms
PC02	STB	Deceleration time constant The time spent for the motor to decelerate from the rated speed to 0 rpm is called "deceleration time constant".	Pr S,T	0 ~20000	ms
PC03	STC	S-pattern acceleration/deceleration time constant The S-pattern acceleration/deceleration function is to employ a three-step curve of acceleration or deceleration moving to soothe the vibration during starting or stopping the motor.	Pr S,T	0 ~10000	ms
PC04	JOG	JOG speed command As JOG mode applied, this PC04 is used as speed command.	Pt, Pr S,T	0 ~4500	rpm
PC05	SC1	Inner speed command/limit 1 For speed control, PC05 is used as inner speed command 1. For torque control, PC05 is the speed limit and directionless.	S,T	-4500 ~+4500	rpm
PC06	SC2	Inner speed command/limit 2 For speed control, PC06 is used as inner speed command 2. For torque control, PC06 is the speed limit and directionless.	S,T	-4500 ~+4500	rpm
PC07	SC3	Inner speed command/limit 3 For speed control, PC07 is used as inner speed command 3. For torque control, PC07 is the speed limit and directionless.	S,T	-4500 ~+4500	rpm
PC08	SC4	Inner speed command/limit 4 For speed control, PC08 is used as inner speed command 4. For torque control, PC08 is the speed limit and directionless.	S,T	-4500 ~+4500	rpm
PC09	SC5	Inner speed command/limit 5 For speed control, PC09 is used as inner speed command 5. For torque control, PC09 is the speed limit and directionless.	S,T	-4500 ~+4500	rpm
PC10	SC6	Inner speed command/limit 6 For speed control, PC10 is used as inner speed command 6. For torque control, PC10 is the speed limit and directionless.	S,T	-4500 ~+4500	rpm
PC11	SC7	Inner speed command/limit 7 For speed control, PC11 is used as inner speed command 7. For torque control, PC11 is the speed limit and directionless.	S,T	-4500 ~+4500	rpm

No	Abbr.	Function description	Control mode	Setting range	Unit				
PC12	VCM	Output speed of maximum analog command This value decides the output speed while the maximum permissible voltage is applied. $\text{output speed} = \frac{\text{applied voltage of speed command}}{10} \times \text{PC12}$	S	0 ~30000	rpm				
		When torque mode is applied, this parameter would become speed limit when the maximum permissible voltage applied. $\text{Speed limit} = \frac{\text{applied voltage of torque command}}{10} \times \text{PC12}$	T	0 ~30000					
PC13	TLC	Torque generated of maximum analog command To decides the maximum torque generated while the maximum permissible voltage is applied. $\text{Torque limit} = \frac{\text{applied voltage of torque command}}{10} \times \text{PC13}$	T	0 ~2000	%				
		Torque generated of maximum analog command When position or speed mode is applied, this parameter is used to limit the output speed.	Pt, Pr S	0 ~2000					
PC14	MOD	Analog monitor output There are 2 channels of analog monitor provided for users to check the required signals. Refer to section 6.9.2 for details.	Pt, Pr S,T	0000h ~0707h	-				
PC15	SVZR	Speed analog zero voltage acknowledged range Treat the applied voltage which is less than PC15 as zero speed command.	S,T	0 ~1000	mV				
PC16	MBR	Electromagnetic brake output delay time The parameter PC16 could be used to decide the delay time of the SON signal off to the MBR signal activated. See section 6.6.3 for more details.	Pt, Pr S,T	0 ~1000	ms				
PC17	ZSP	Zero speed acknowledged range As motor feedback speed is less than the setting value of PC17, the servo drive would treat it as zero speed and the ZSP of DO would be outputted.	Pt, Pr S,T	0 ~10000	rpm				
PC18	COP1	Stop option and power interruption restart option The voltage level drop would cause drive to alarm and stop. Auto-restart function could be applied by the setting of PC18. <table border="1" style="display: inline-table; vertical-align: middle;"> <tr> <td>0</td> <td>0</td> <td>y</td> <td>x</td> </tr> </table> <u>x: power interruption restart option</u> 0: invalid 1: valid <u>y: motor stop option</u> 0: stops instantaneously 1: decelerates to stop	0	0	y	x	Pt, Pr S,T	0000h ~0011h	-
0	0	y	x						

No	Abbr.	Function description	Control mode	Setting range	Unit
PC19	COP2	Alarm history clear option and overload early warning option <div style="border: 1px solid black; display: inline-block; padding: 2px;">0 0 y x</div> <u>x: Alarm history clear option</u> 0: does not clear 1: to clear the histories after power off once and restart <u>y: overload pre-warn option</u> 0: invalid 1: to stop the motor when the early warning occurred	Pt, Pr S,T	0000h ~0011h	-
PC20	SNO	Communication device number To set different device number for varied devices is necessary. If two drives occupy the same number, the communication could not be performed.	Pt, Pr S,T	1 ~32	-
PC21	CMS	Communication mode option <div style="border: 1px solid black; display: inline-block; padding: 2px;">0 0 0 x</div> <u>x: communication reply delay time</u> 0: reply within 1 ms 1: reply after 1 ms	Pt, Pr S,T	0000h ~0011h	-
PC22	BPS	Communication protocol option <div style="border: 1px solid black; display: inline-block; padding: 2px;">0 0 y x</div> <u>x: protocol option</u> 0: 7 data bit, No parity, 2 stop bit (Modbus, ASCII Mode) 1: 7 data bit, Even parity, 1 stop bit (Modbus, ASCII Mode) 2: 7 data bit, Odd parity, 1 stop bit (Modbus, ASCII Mode) 3: 8 data bit, No parity, 2 stop bit (Modbus, ASCII Mode) 4: 8 data bit, Even parity, 1 stop bit (Modbus, ASCII Mode) 5: 8 data bit, Odd parity, 1 stop bit (Modbus, ASCII Mode) 6: 8 data bit, No parity, 2 stop bit (Modbus, RTU Mode) 7: 8 data bit, Even parity, 1 stop bit (Modbus, RTU Mode) 8: 8 data bit, Odd parity, 1 stop bit (Modbus, RTU Mode) <u>y: baud rate option</u> 0: 4800 bps 1: 9600 bps 2: 19200 bps 3: 38400 bps 4: 57600 bps 5: 115200 bps	Pt, Pr S,T	0000h ~0058h	-
PC23	SIC	Communication time-out process option Time-out inspection could be set from 1 to 60 seconds. If it is set as 0, the inspection function is invalid.	Pt, Pr S,T	0 ~60	S

No	Abbr.	Function description	Control mode	Setting range	Unit																		
PC24	DMD	<p>Status display option</p> <table border="1" style="margin-left: 20px;"> <tr> <td style="width: 20px; text-align: center;">0</td> <td style="width: 20px; text-align: center;">0</td> <td style="width: 20px; text-align: center;">y</td> <td style="width: 20px; text-align: center;">x</td> </tr> </table> <p><u>x: display option after power on</u></p> <ul style="list-style-type: none"> <li>0: Motor feedback pulse</li> <li>1: Motor feedback revolution</li> <li>2: Cumulative pulses of command</li> <li>3: Cumulative turns of command</li> <li>4: Accumulative pulses error</li> <li>5: Command pulse frequency</li> <li>6: Motor speed</li> <li>7: Speed analog command/limit voltage</li> <li>8: Speed input command/limit</li> <li>9: Torque analog command/limit voltage</li> <li>A: Torque input command/limit</li> <li>B: Effective load ratio</li> <li>C: Peak load ratio</li> <li>D: DC bus voltage</li> <li>E: The ratio of load inertia to motor shaft</li> <li>F: Instantaneous torque</li> <li>10: Regenerative load ratio</li> <li>11~13: Z phase reference absolute pulse</li> </ul> <p><u>y: assigned display after power on</u></p> <ul style="list-style-type: none"> <li>0: display option according varied control modes</li> <li>1: display option according the x-digit of PC24</li> </ul> <table border="1" style="margin-left: 20px; width: 100%;"> <thead> <tr> <th style="width: 30%;">Control mode</th> <th>Initial display after power on</th> </tr> </thead> <tbody> <tr> <td>position</td> <td>motor feedback pulse</td> </tr> <tr> <td>position/speed</td> <td>motor feedback pulses/motor speed</td> </tr> <tr> <td>speed</td> <td>motor speed</td> </tr> <tr> <td>speed/torque</td> <td>motor speed / torque analog command</td> </tr> <tr> <td>torque</td> <td>torque analog command</td> </tr> <tr> <td>torque/position</td> <td>torque analog command/motor feedback pulse</td> </tr> </tbody> </table>	0	0	y	x	Control mode	Initial display after power on	position	motor feedback pulse	position/speed	motor feedback pulses/motor speed	speed	motor speed	speed/torque	motor speed / torque analog command	torque	torque analog command	torque/position	torque analog command/motor feedback pulse	Pt, Pr S,T	0000h ~0113h	-
0	0	y	x																				
Control mode	Initial display after power on																						
position	motor feedback pulse																						
position/speed	motor feedback pulses/motor speed																						
speed	motor speed																						
speed/torque	motor speed / torque analog command																						
torque	torque analog command																						
torque/position	torque analog command/motor feedback pulse																						
PC25	TL2	<p>Inner torque limit 2</p> <p>Refer to description of PA05.</p>	Pt, Pr S,T	0 ~100	%																		
PC26	VCO	<p>Speed analog command/limit offset</p> <p>Used to “compensate” the analog offset for a zero command. Speed analog command (VC) is corrected for speed control. Speed analog limit (VLA) is corrected for torque control mode. Refer to section 4.5.5 for more details.</p>	S,T	-8000 ~+8000	mV																		
PC27	TLO	<p>Torque analog command/limit offset</p> <p>Used to “compensate” the analog offset for a zero command. Torque analog command (TC) is corrected for torque control mode. Torque output analog limit (TLA) is corrected for speed control mode. Refer to section 4.5.5 for more details.</p>	S,T	-8000 ~+8000	mV																		

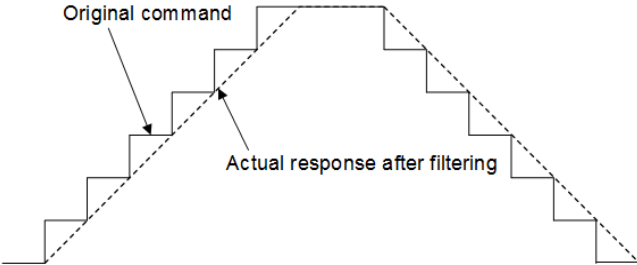
No	Abbr.	Function description	Control mode	Setting range	Unit
PC28	MO1	Analog monitor ch1 offset Used to set the output offset voltage of analog monitor MON 1.	Pt, Pr S,T	-999 ~+999	mV
PC29	MO2	Analog monitor ch2 offset Used to set the output offset voltage of analog monitor MON 2.	Pt, Pr S,T	-999 ~+999	mV
PC30	MOG1	Analog monitor ch1 output proportion Used to set output ratio of monitor signal to be viewed.	Pt, Pr S,T	1 ~100	%
PC31	MOG2	Analog monitor ch2 output proportion	Pt, Pr S,T	1 ~100	%
PC32	CMX2	Electronic gear numerator 2 Refer to the description of PA06.	Pt, Pr	1 ~2 <sup>26</sup>	-
PC33	CMX3	Electronic gear numerator 3	Pt, Pr	1 ~2 <sup>26</sup>	-
PC34	CMX4	Electronic gear numerator 4	Pt, Pr	1 ~2 <sup>26</sup>	-
PC35	VCL	VC input voltage limit Used to limit the range of speed analog command(VC). "0" denotes no limit. A "5000" setting of PC35 as an example : even the actual analog command is 10V, the drive would recognize that the maximum input voltage is only 5V.	S,T	0 ~20000	mV
PC36	VMFT	VC/VLA linear voltage filter time constant This is a moving filter. It is unlike the PB18 which is a low-pass filter. The difference between them is that PC36 affords both start and stop smoothing effect, but PB18 affords only stop smoothing effect. If speed mode is applied with the superior controller command to perform position loop control, the PB18 is recommended. If pure speed or torque mode is applied, use PC36 to obtain a better smoothing effect. 	S,T	0 ~40	0.1ms
PC37	DTA9	AL09 occurrence delay time The delay time of t AL09 occurrence detection after power on. The "0" setting value means this delay disabled.	Pt, Pr S,T	0 ~20000	ms

No	Abbr.	Function description	Control mode	Setting range	Unit																		
PC38	FNO4	<p>Function option 4</p> <p>Initiate the contact status of DO1 to DO6 when the servo drive is power on. The contact status of DO1 to DO6 is defined by the Bit 0 to Bit 5 of this parameter.</p> <table border="1" style="margin-left: auto; margin-right: auto;"> <thead> <tr> <th colspan="6">PC38</th> </tr> <tr> <th>Bit 5</th> <th>Bit 4</th> <th>Bit 3</th> <th>Bit 2</th> <th>Bit 1</th> <th>Bit 0</th> </tr> </thead> <tbody> <tr> <td>DO6</td> <td>DO5</td> <td>DO4</td> <td>DO3</td> <td>DO2</td> <td>DO1</td> </tr> </tbody> </table> <p>0: Initiate the DOx status as a NO contact. (a contact)  1: Initiate the DOx status as a NC contact. (b contact)  x=1~6</p>	PC38						Bit 5	Bit 4	Bit 3	Bit 2	Bit 1	Bit 0	DO6	DO5	DO4	DO3	DO2	DO1	Pr, Pt S,T	0000h ~003Fh	-
PC38																							
Bit 5	Bit 4	Bit 3	Bit 2	Bit 1	Bit 0																		
DO6	DO5	DO4	DO3	DO2	DO1																		
PC39		Reserved																					
PC40	MBR2	<p>The delay time to release electromagnetic brake</p> <p>When MBR DO function is valid, this parameter is to define the delay time of electromagnetic brake released when SERVO ON activated.</p>	Pr, Pt S,T	0 ~1000	ms-																		
PC41~PC60		Reserved																					

No	Abbr.	Function description	Control mode	Setting range	Unit
PD01	DIA1	Digital input signal auto-ON option 1 <div style="border: 1px solid black; display: inline-block; padding: 2px;">u   z   y   x</div> <u>x: SON open/short option</u> 0: controlled by external actual wiring 1: SON-SG is short-circuit without actual wiring <u>y: LSP open/short option</u> 0: controlled by external actual wiring 1: LSP-SG is short-circuit without actual wiring <u>z: LSN open/short option</u> 0: controlled by external actual wiring 1: LSN-SG is short-circuit without actual wiring <u>u: EMG open/short option</u> 0: controlled by external actual wiring 1: EMG-SG is short-circuit without actual wiring	Pt, Pr S,T	0000h ~1111h	-
PD02	DI1	Digital input 1 option The 12 DI input pins of CN1 are programmable. The default pin functions are different corresponding to varied control modes.	Pt, Pr S,T	0000h ~002Fh	-
PD03	DI2	Digital input 2 option	Pt, Pr S,T	0000h ~002Fh	-
PD04	DI3	Digital input 3 option	Pt, Pr S,T	0000h ~002Fh	-
PD05	DI4	Digital input 4 option	Pt, Pr S,T	0000h ~002Fh	-
PD06	DI5	Digital input 5 option	Pt, Pr S,T	0000h ~002Fh	-
PD07	DI6	Digital input 6 option	Pt, Pr S,T	0000h ~002Fh	-
PD08	DI7	Digital input 7 option	Pt, Pr S,T	0000h ~002Fh	-
PD09	DI8	Digital input 8 option	Pt, Pr S,T	0000h ~002Fh	-
PD10	DO1	Digital output 1 option The DO output pins of CN1 are programmable. The default pin functions are different corresponding to varied control mode.	Pt, Pr S,T	0000h ~001Fh	-
PD11	DO2	Digital output 2 option	Pt, Pr S,T	0000h ~001Fh	-
PD12	DO3	Digital output 3 option	Pt, Pr S,T	0000h ~001Fh	-
PD13	DO4	Digital output 4 option	Pt, Pr S,T	0000h ~001Fh	-
PD14	DO5	Digital output 5 option	Pt, Pr S,T	0000h ~001Fh	-

No	Abbr.	Function description	Control mode	Setting range	Unit
PD15	DIF	Digital input filter time option <div style="border: 1px solid black; display: inline-block; padding: 2px;">0 0 0 x</div> <u>x: filter time constant</u> 0: invalid 1: 2mS 2: 4mS 3: 6mS 4: 8mS 5: 10mS	Pt, Pr S,T	0000h ~0005h	-
PD16	SDI	Digital input on/off control source option Each bit of this parameter is to decide the on/off control source of corresponding DI. The bit definition is described as follows. 0: The specified DI is controlled by the actual wirings. 1: The specified DI is controlled by communication software	Pt, Pr S,T	0000h ~0FFFh	-
PD17	DOP1	LSP/LSN triggered stop option <div style="border: 1px solid black; display: inline-block; padding: 2px;">0 0 0 x</div> <u>x: motor stop option</u> 0: stops immediately 1: decelerates to stop according to PF81 setting	Pt, Pr S	0000h ~0001h	-
PD18	DOP2	CR signal clear option As CR signal is activated, the deference between position pulses and motor feedback pulses would be cleared. <div style="border: 1px solid black; display: inline-block; padding: 2px;">0 0 0 x</div> <u>x: clear option</u> 0: CR rising edge trigger 1: keeps clearing while CR=1 2: As CR is triggered, the motor would decelerate to stop. The remainder of pulse commands would be neglected. If CTRG signal is triggered again, the present commands would be executed. Here is the process chart.	Pt, Pr	0000h ~0002h	-

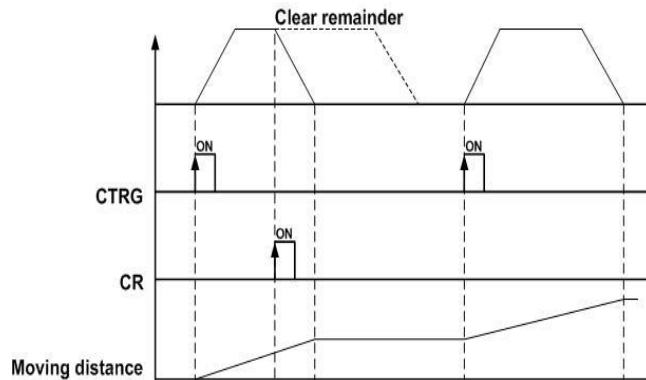



No	Abbr.	Function description	Control mode	Setting range	Unit																																																																													
PD19	DOP3	<p>Alarm code output option</p> <table border="1"> <tr> <td>0</td> <td>0</td> <td>0</td> <td>x</td> </tr> </table> <p>x: output option</p> <p>0: DO function according to PD10 ~ PD14 setting 1: to show alarm codes while alarms occurred</p> <table border="1"> <tr> <td>x</td> <td>CN1-41</td> <td>CN1-42</td> <td>CN1-45</td> </tr> <tr> <td>0</td> <td>DO function</td> <td>DO function</td> <td>DO function</td> </tr> <tr> <td>1</td> <td colspan="3">Alarm code</td> </tr> </table> <table border="1"> <thead> <tr> <th colspan="3">CN1</th> <th rowspan="2">code</th> <th rowspan="2">Alarm name</th> </tr> <tr> <th>41</th> <th>42</th> <th>45</th> </tr> </thead> <tbody> <tr> <td rowspan="5">0</td> <td rowspan="5">0</td> <td rowspan="5">0</td> <td>AL 09</td> <td>Communication abnormal</td> </tr> <tr> <td>AL. 0A</td> <td>Communication time-out</td> </tr> <tr> <td>AL. 0E</td> <td>IGBT overheat</td> </tr> <tr> <td>AL. 0F</td> <td>Memory error</td> </tr> <tr> <td>AL. 10</td> <td>Overload 2</td> </tr> <tr> <td>0</td> <td>0</td> <td>1</td> <td>AL. 02</td> <td>Low voltage</td> </tr> <tr> <td rowspan="2">0</td> <td rowspan="2">1</td> <td rowspan="2">0</td> <td>AL. 01</td> <td>Over voltage</td> </tr> <tr> <td>AL. 04</td> <td>Regenerative alarm</td> </tr> <tr> <td>0</td> <td>1</td> <td>1</td> <td>AL. 03</td> <td>Over current</td> </tr> <tr> <td rowspan="4">1</td> <td rowspan="4">0</td> <td rowspan="4">1</td> <td>AL. 05</td> <td>Overload 1</td> </tr> <tr> <td>AL. 06</td> <td>Over speed</td> </tr> <tr> <td>AL. 07</td> <td>Pulse command abnormal</td> </tr> <tr> <td>AL. 08</td> <td>Position error excessive</td> </tr> <tr> <td rowspan="2">1</td> <td rowspan="2">1</td> <td rowspan="2">0</td> <td>AL. 0B</td> <td>Encoder error 1</td> </tr> <tr> <td>AL. 0C</td> <td>Encoder error 2</td> </tr> <tr> <td>1</td> <td>1</td> <td>1</td> <td>AL. 11</td> <td>Motor mismatch</td> </tr> </tbody> </table>	0	0	0	x	x	CN1-41	CN1-42	CN1-45	0	DO function	DO function	DO function	1	Alarm code			CN1			code	Alarm name	41	42	45	0	0	0	AL 09	Communication abnormal	AL. 0A	Communication time-out	AL. 0E	IGBT overheat	AL. 0F	Memory error	AL. 10	Overload 2	0	0	1	AL. 02	Low voltage	0	1	0	AL. 01	Over voltage	AL. 04	Regenerative alarm	0	1	1	AL. 03	Over current	1	0	1	AL. 05	Overload 1	AL. 06	Over speed	AL. 07	Pulse command abnormal	AL. 08	Position error excessive	1	1	0	AL. 0B	Encoder error 1	AL. 0C	Encoder error 2	1	1	1	AL. 11	Motor mismatch	Pt, Pr S,T	0000h ~0001h	-
0	0	0	x																																																																															
x	CN1-41	CN1-42	CN1-45																																																																															
0	DO function	DO function	DO function																																																																															
1	Alarm code																																																																																	
CN1			code	Alarm name																																																																														
41	42	45																																																																																
0	0	0	AL 09	Communication abnormal																																																																														
			AL. 0A	Communication time-out																																																																														
			AL. 0E	IGBT overheat																																																																														
			AL. 0F	Memory error																																																																														
			AL. 10	Overload 2																																																																														
0	0	1	AL. 02	Low voltage																																																																														
0	1	0	AL. 01	Over voltage																																																																														
			AL. 04	Regenerative alarm																																																																														
0	1	1	AL. 03	Over current																																																																														
1	0	1	AL. 05	Overload 1																																																																														
			AL. 06	Over speed																																																																														
			AL. 07	Pulse command abnormal																																																																														
			AL. 08	Position error excessive																																																																														
1	1	0	AL. 0B	Encoder error 1																																																																														
			AL. 0C	Encoder error 2																																																																														
1	1	1	AL. 11	Motor mismatch																																																																														
PD20	DOP4	<p>Alarm reset triggered process</p> <table border="1"> <tr> <td>0</td> <td>0</td> <td>0</td> <td>x</td> </tr> </table> <p>x: clear option</p> <p>0: PWM signal off (If the motor is running, it would coast to stop. If the motor is shaft-lock, it would become rotatable.) 1: invalid</p>	0	0	0	x	Pt, Pr S,T	0000h ~001Fh	-																																																																									
0	0	0	x																																																																															
PD21	DI9	<p>Digital input 9 option</p> <p>The 12 DI input pins of CN1 are programmable. The default pin functions are different corresponding to varied control modes.</p>	Pt, Pr S,T	0000h ~002Fh	-																																																																													

No	Abbr.	Function description	Control mode	Setting range	Unit																																																										
PD22	DI10	Digital input 10 option	Pt, Pr S,T	0000h ~002Fh	-																																																										
PD23	DI11	Digital input 11 option	Pt, Pr S,T	0000h ~002Fh	-																																																										
PD24	DI12	Digital input 12 option	Pt, Pr S,T	0000h ~002Fh	-																																																										
PD25	ITST	<p>Communication control DI on/off</p> <p>To set this parameter to determine the on/off state of Digital Inputs (DI) if the PC communication software is applied. The bit0~ bit11 correspond with DI1~ DI12. The PD16 (DI on/off state control option) determines whether if the source is the external signals or PC communication software. To read the PD25, if the value is 0011h, it means that the state of DI1 and DI5 are ON. If to write 0011h to the PD25, it means that the command state of DI1 and DI5 are ON.</p> <p>Example 1: If the setting of PD16 is 0FFFh, the setting of PD25 is 0000h, it denotes the PC communication software determines all DI on/off status via the PD25 setting. Even the external actual hardware pins are all activated with SG.</p> <p>Example 2:</p> <table style="margin-left: auto; margin-right: auto;"> <tr> <td></td> <td colspan="2" style="text-align: center;">DI12 bit11</td> <td style="text-align: center;">AND</td> <td colspan="2"></td> <td style="text-align: center;">OR</td> <td colspan="2"></td> <td style="text-align: center;">DI1 bit0</td> </tr> <tr> <td>external</td> <td>1</td> <td>1</td> <td>1</td> <td>1</td> <td>0</td> <td>0</td> <td>0</td> <td>0</td> <td>1</td> <td>1</td> <td>1</td> </tr> <tr> <td>PD16</td> <td>1</td> <td>1</td> <td>1</td> <td>1</td> <td>1</td> <td>1</td> <td>0</td> <td>0</td> <td>0</td> <td>0</td> <td>0</td> </tr> <tr> <td>PD25</td> <td>1</td> <td>1</td> <td>1</td> <td>0</td> <td>0</td> <td>0</td> <td>1</td> <td>1</td> <td>1</td> <td>0</td> <td>0</td> </tr> <tr> <td>Result</td> <td>1</td> <td>1</td> <td>1</td> <td>0</td> <td>0</td> <td>0</td> <td>0</td> <td>0</td> <td>1</td> <td>1</td> <td>1</td> </tr> </table> <p>According to the condition above, DI12~ DI7's on/off status is determined via the PC communication software, DI6~ DI1's status is controlled by the actual hardware pin state. Since the external actual pin status is 111100001111, the PD25 setting is 111000111000, the final result is 111000001111.</p>		DI12 bit11		AND			OR			DI1 bit0	external	1	1	1	1	0	0	0	0	1	1	1	PD16	1	1	1	1	1	1	0	0	0	0	0	PD25	1	1	1	0	0	0	1	1	1	0	0	Result	1	1	1	0	0	0	0	0	1	1	1	Pt, Pr S,T	0000h ~0FFFFh	-
	DI12 bit11		AND			OR			DI1 bit0																																																						
external	1	1	1	1	0	0	0	0	1	1	1																																																				
PD16	1	1	1	1	1	1	0	0	0	0	0																																																				
PD25	1	1	1	0	0	0	1	1	1	0	0																																																				
Result	1	1	1	0	0	0	0	0	1	1	1																																																				
PD26	DO6	<p>Digital output 6 option</p> <p>The 6 DO output pins of CN1 are programmable. The preset pin functions are different corresponding to varied control modes.</p>	Pt, Pr S,T	0000h ~002Fh	-																																																										
PD27	DOD	<p>Digital output logic option</p> <p>To define the logic of DO1~ DO6. The bit0~ bit5 corresponds to DI1~ DI6. Contact A or contact B is selectable.</p> <p>0: normal open contact A 1: normal close contact B</p>	Pt, Pr S,T	0000h ~003Fh	-																																																										

No	Abbr.	Function description	Control mode	Setting range	Unit				
PD28	MCOK	<p>Motion completion (DO: MC_OK) option</p> <table border="1" style="margin-left: 20px;"> <tr> <td>0</td> <td>0</td> <td>y</td> <td>x</td> </tr> </table> <p><u>x: output option</u>  0: not to hold  1: to hold</p> <p><u>y: motion error option</u>  0: AL1B is invalid  1: AL1B is valid</p>	0	0	y	x	Pt, Pr S,T	0000h ~002Fh	-
0	0	y	x						
PD29	DID	<p>DI signal contact definition</p> <p>To define the input logic of DI signal. Bit 0~ bit 11 corresponds to DI1~ DI12.</p> <p>0: normal open contact A  1: normal close contact B</p> <p>Note: If any DI is assigned to be controlled by the PC communication software, this application is invalid. Refer to the parameter PD16 description.</p>	Pt, Pr S,T	0000h ~0FFFh	-				
PD30	SDO	<p>Switch of DO control source (turret application)</p> <p>To determine the control source of DO1 to DO6 with PD30 bits.</p> <p>0: DOx status is depended on the drive program executed.  1: DOx status is depended on the setting of PD30.  x=1~6</p>	Turret	0000h ~003Fh	-				
PD31	OTST	<p>Communication control DO on/off</p> <p>To set this parameter to determine the on/off state of Digital Outputs (DO). Refer to PD25 setting for more detail description.</p>	Turret	0000h ~003Fh	-				
PD32	SDLY	<p>Servo ON delay time</p> <p>To delay a time when Servo ON instruction is activated.</p>	Pt, Pr S,T	0 ~3000	ms				
PD33~ PD40		Reserved							

No	Abbr.	Function description	Control mode	Setting range	Unit																														
PE01	ODEF	<p>Origin return definition</p> <p>Bit definition of PE01 parameter is described as below.</p> <table border="1" style="margin-left: 20px;"> <thead> <tr> <th colspan="7">PE01</th> </tr> <tr> <th>31-28</th> <th>27-24</th> <th>23-20</th> <th>19-16</th> <th>15-12</th> <th>11-8</th> <th>7-0</th> </tr> </thead> <tbody> <tr> <td>BOOT</td> <td>-</td> <td>DLY</td> <td>-</td> <td>DEC</td> <td>ACC</td> <td>PATH</td> </tr> </tbody> </table> <p><u>PATH</u>: stroke option  0: stop  1~63: to execute a assigned stroke</p> <p><u>ACC</u>: acceleration time option  0~F: corresponded to PF49~PF64</p> <p><u>DEC</u>: deceleration time option  0~F: corresponded to PF49~PF64</p> <p><u>DLY</u>: delay time option  0~F: corresponded to PF65~PF80</p> <p><u>BOOT</u>: origin return option after the drive is power on  0: Not to execute origin return  1: To execute origin return</p> <p>The relevant parameters for origin return are also described.  PA04: Home moving option  PA08~PA09: Home moving high speed option 1 &amp; 2  PE02: Define a offset numeric value for origin  Please refer to chapter 7 for a more detail description.</p>	PE01							31-28	27-24	23-20	19-16	15-12	11-8	7-0	BOOT	-	DLY	-	DEC	ACC	PATH	Pr	0000000h ~10FFFF3Fh	-									
PE01																																			
31-28	27-24	23-20	19-16	15-12	11-8	7-0																													
BOOT	-	DLY	-	DEC	ACC	PATH																													
PE02	ODAT	<p>Origin offset value definition</p> <p>To define a offset numeric value for origin.</p> <table border="1" style="margin-left: 20px;"> <thead> <tr> <th>ORG_DEF</th> </tr> </thead> <tbody> <tr> <td>32 bits</td> </tr> </tbody> </table>	ORG_DEF	32 bits	Pr	$-(2^{31}+1)$ ~ $(2^{31}-1)$	-																												
ORG_DEF																																			
32 bits																																			
PE03	PDEF1	<p>PATH#1 definition</p> <p>Bit definition of PE03 parameter is described as below.</p> <table border="1" style="margin-left: 20px;"> <thead> <tr> <th colspan="4">OPT</th> <th>TYPE</th> </tr> <tr> <th>bit7</th> <th>bit6</th> <th>bit5</th> <th>bit4</th> <th>bit3~bit0</th> </tr> </thead> <tbody> <tr> <td>-</td> <td>UNIT</td> <td>AUTO</td> <td>INS</td> <td>1 : SPEED constant speed control</td> </tr> <tr> <td colspan="2">CMD</td> <td>OVLP</td> <td>INS</td> <td>2 : SINGLE one stroke execution 3 : AUTO reload next executed strokes</td> </tr> <tr> <td>-</td> <td>-</td> <td>-</td> <td>INS</td> <td>7 : JUMP to an assigned stroke</td> </tr> <tr> <td>-</td> <td>-</td> <td>AUTO</td> <td>INS</td> <td>8 : WRITE an parameter modification</td> </tr> </tbody> </table> <p><u>INS</u>: insertion command of an assigned stroke  <u>OVLP</u>: a permission to overlap the next stroke  <u>AUTO</u>: reload the next stroke execution  <u>CMD</u>: reload the next stroke execution  Please refer to chapter 7 for a more detail description.</p>	OPT				TYPE	bit7	bit6	bit5	bit4	bit3~bit0	-	UNIT	AUTO	INS	1 : SPEED constant speed control	CMD		OVLP	INS	2 : SINGLE one stroke execution 3 : AUTO reload next executed strokes	-	-	-	INS	7 : JUMP to an assigned stroke	-	-	AUTO	INS	8 : WRITE an parameter modification	Pr	0000000h ~ FFFFFFFh	-
OPT				TYPE																															
bit7	bit6	bit5	bit4	bit3~bit0																															
-	UNIT	AUTO	INS	1 : SPEED constant speed control																															
CMD		OVLP	INS	2 : SINGLE one stroke execution 3 : AUTO reload next executed strokes																															
-	-	-	INS	7 : JUMP to an assigned stroke																															
-	-	AUTO	INS	8 : WRITE an parameter modification																															

No	Abbr.	Function description	Control mode	Setting range	Unit
PE04	PDAT1	PATH#1 data To define the destination of PATH#1, or the goal PATH that is going to jump.	Pr	Non-index: -(2 <sup>31</sup> +1) ~(2 <sup>31</sup> -1) Index: 0~4194304	-
PE05	PDEF2	PATH#2 definition Please refer to PE03 instruction.	Pr	00000000h ~ FFFFFFFFh	-
PE06	PDAT2	PATH#2 data Please refer to PE04 instruction.	Pr	-(2 <sup>31</sup> +1) ~(2 <sup>31</sup> -1)	-
PE07	PDEF3	PATH#3 definition Please refer to PE03 instruction.	Pr	00000000h ~ FFFFFFFFh	-
PE08	PDAT3	PATH#3 data Please refer to PE04 instruction.	Pr	-(2 <sup>31</sup> +1) ~(2 <sup>31</sup> -1)	-
PE09	PDEF4	PATH#4 definition Please refer to PE03 instruction.	Pr	00000000h ~ FFFFFFFFh	-
PE10	PDAT4	PATH#4 data Please refer to PE04 instruction.	Pr	-(2 <sup>31</sup> +1) ~(2 <sup>31</sup> -1)	-
PE11	PDEF5	PATH#5 definition Please refer to PE03 instruction.	Pr	00000000h ~ FFFFFFFFh	-
PE12	PDAT5	PATH#5 data Please refer to PE04 instruction.	Pr	-(2 <sup>31</sup> +1) ~(2 <sup>31</sup> -1)	-
PE13	PDEF6	PATH#6 definition Please refer to PE03 instruction.	Pr	00000000h ~ FFFFFFFFh	-
PE14	PDAT6	PATH#6 data Please refer to PE04 instruction.	Pr	-(2 <sup>31</sup> +1) ~(2 <sup>31</sup> -1)	-
PE15	PDEF7	PATH#7 definition Please refer to PE03 instruction.	Pr	00000000h ~ FFFFFFFFh	-
PE16	PDAT7	PATH#7 data Please refer to PE04 instruction.	Pr	-(2 <sup>31</sup> +1) ~(2 <sup>31</sup> -1)	-
PE17	PDEF8	PATH#8 definition Please refer to PE03 instruction.	Pr	00000000h ~ FFFFFFFFh	-
PE18	PDAT8	PATH#8 data Please refer to PE04 instruction.	Pr	-(2 <sup>31</sup> +1) ~(2 <sup>31</sup> -1)	-
PE19	PDEF9	PATH#9 definition Please refer to PE03 instruction.	Pr	00000000h ~ FFFFFFFFh	-
PE20	PDAT9	PATH#9 data Please refer to PE04 instruction.	Pr	-(2 <sup>31</sup> +1) ~(2 <sup>31</sup> -1)	-

No	Abbr.	Function description	Control mode	Setting range	Unit
PE21	PDEF10	PATH#10 definition Please refer to PE03 instruction.	Pr	00000000h ~ FFFFFFFFh	-
PE22	PDAT10	PATH#10 data Please refer to PE04 instruction.	Pr	$-(2^{31}+1)$ ~ $-(2^{31}-1)$	-
PE23	PDEF11	PATH#11 definition Please refer to PE03 instruction.	Pr	00000000h ~ FFFFFFFFh	-
PE24	PDAT11	PATH#11 data Please refer to PE04 instruction.	Pr	$-(2^{31}+1)$ ~ $-(2^{31}-1)$	-
PE25	PDEF12	PATH#12 definition Please refer to PE03 instruction.	Pr	00000000h ~ FFFFFFFFh	-
PE26	PDAT12	PATH#12 data Please refer to PE04 instruction.	Pr	$-(2^{31}+1)$ ~ $-(2^{31}-1)$	-
PE27	PDEF13	PATH#13 definition Please refer to PE03 instruction.	Pr	00000000h ~ FFFFFFFFh	-
PE28	PDAT13	PATH#13 data Please refer to PE04 instruction.	Pr	$-(2^{31}+1)$ ~ $-(2^{31}-1)$	-
PE29	PDEF14	PATH#14 definition Please refer to PE03 instruction.	Pr	00000000h ~ FFFFFFFFh	-
PE30	PDAT14	PATH#14 data Please refer to PE04 instruction.	Pr	$-(2^{31}+1)$ ~ $-(2^{31}-1)$	-
PE31	PDEF15	PATH#15 definition Please refer to PE03 instruction.	Pr	00000000h ~ FFFFFFFFh	-
PE32	PDAT15	PATH#15 data Please refer to PE04 instruction.	Pr	$-(2^{31}+1)$ ~ $-(2^{31}-1)$	-
PE33	PDEF16	PATH#16 definition Please refer to PE03 instruction.	Pr	00000000h ~ FFFFFFFFh	-
PE34	PDAT16	PATH#16 data Please refer to PE04 instruction.	Pr	$-(2^{31}+1)$ ~ $-(2^{31}-1)$	-
PE35	PDEF17	PATH#17 definition Please refer to PE03 instruction.	Pr	00000000h ~ FFFFFFFFh	-
PE36	PDAT17	PATH#17 data Please refer to PE04 instruction.	Pr	$-(2^{31}+1)$ ~ $-(2^{31}-1)$	-

No	Abbr.	Function description	Control mode	Setting range	Unit
PE37	PDEF18	PATH#18 definition Please refer to PE03 instruction.	Pr	00000000h ~ FFFFFFFFh	-
PE38	PDAT18	PATH#18 data Please refer to PE04 instruction.	Pr	$-(2^{31}+1)$ ~ $-(2^{31}-1)$	-
PE39	PDEF19	PATH#19 definition Please refer to PE03 instruction.	Pr	00000000h ~ FFFFFFFFh	-
PE40	PDAT19	PATH#19 data Please refer to PE04 instruction.	Pr	$-(2^{31}+1)$ ~ $-(2^{31}-1)$	-
PE41	PDEF20	PATH#20 definition Please refer to PE03 instruction.	Pr	00000000h ~ FFFFFFFFh	-
PE42	PDAT20	PATH#20 data Please refer to PE04 instruction.	Pr	$-(2^{31}+1)$ ~ $-(2^{31}-1)$	-
PE43	PDEF21	PATH#21 definition Please refer to PE03 instruction.	Pr	00000000h ~ FFFFFFFFh	-
PE44	PDAT21	PATH#21 data Please refer to PE04 instruction.	Pr	$-(2^{31}+1)$ ~ $-(2^{31}-1)$	-
PE45	PDEF22	PATH#22 definition Please refer to PE03 instruction.	Pr	00000000h ~ FFFFFFFFh	-
PE46	PDAT22	PATH#22 data Please refer to PE04 instruction.	Pr	$-(2^{31}+1)$ ~ $-(2^{31}-1)$	-
PE47	PDEF23	PATH#23 definition Please refer to PE03 instruction.	Pr	00000000h ~ FFFFFFFFh	-
PE48	PDAT23	PATH#23 data Please refer to PE04 instruction.	Pr	$-(2^{31}+1)$ ~ $-(2^{31}-1)$	-
PE49	PDEF24	PATH#24 definition Please refer to PE03 instruction.	Pr	00000000h ~ FFFFFFFFh	-
PE50	PDAT24	PATH#24 data Please refer to PE04 instruction.	Pr	$-(2^{31}+1)$ ~ $-(2^{31}-1)$	-
PE51	PDEF25	PATH#25 definition Please refer to PE03 instruction.	Pr	00000000h ~ FFFFFFFFh	-
PE52	PDAT25	PATH#25 data Please refer to PE04 instruction.	Pr	$-(2^{31}+1)$ ~ $-(2^{31}-1)$	-

No	Abbr.	Function description	Control mode	Setting range	Unit
PE53	PDEF26	PATH#26 definition Please refer to PE03 instruction.	Pr	00000000h ~ FFFFFFFFh	-
PE54	PDAT26	PATH#26 data Please refer to PE04 instruction.	Pr	$-(2^{31}+1)$ ~ $-(2^{31}-1)$	-
PE55	PDEF27	PATH#27 definition Please refer to PE03 instruction.	Pr	00000000h ~ FFFFFFFFh	-
PE56	PDAT27	PATH#27 data Please refer to PE04 instruction.	Pr	$-(2^{31}+1)$ ~ $-(2^{31}-1)$	-
PE57	PDEF28	PATH#28 definition Please refer to PE03 instruction.	Pr	00000000h ~ FFFFFFFFh	-
PE58	PDAT28	PATH#28 data Please refer to PE04 instruction.	Pr	$-(2^{31}+1)$ ~ $-(2^{31}-1)$	-
PE59	PDEF29	PATH#29 definition Please refer to PE03 instruction.	Pr	00000000h ~ FFFFFFFFh	-
PE60	PDAT29	PATH#29 data Please refer to PE04 instruction.	Pr	$-(2^{31}+1)$ ~ $-(2^{31}-1)$	-
PE61	PDEF30	PATH#30 definition Please refer to PE03 instruction.	Pr	00000000h ~ FFFFFFFFh	-
PE62	PDAT30	PATH#30 data Please refer to PE04 instruction.	Pr	$-(2^{31}+1)$ ~ $-(2^{31}-1)$	-
PE63	PDEF31	PATH#31 definition Please refer to PE03 instruction.	Pr	00000000h ~ FFFFFFFFh	-
PE64	PDAT31	PATH#31 data Please refer to PE04 instruction.	Pr	$-(2^{31}+1)$ ~ $-(2^{31}-1)$	-
PE65	PDEF32	PATH#32 definition Please refer to PE03 instruction.	Pr	00000000h ~ FFFFFFFFh	-
PE66	PDAT32	PATH#32 data Please refer to PE04 instruction.	Pr	$-(2^{31}+1)$ ~ $-(2^{31}-1)$	-
PE67	PDEF33	PATH#33 definition Please refer to PE03 instruction.	Pr	00000000h ~ FFFFFFFFh	-
PE68	PDAT33	PATH#33 data Please refer to PE04 instruction.	Pr	$-(2^{31}+1)$ ~ $-(2^{31}-1)$	-



No	Abbr.	Function description	Control mode	Setting range	Unit
PE69	PDEF34	PATH#34 definition Please refer to PE03 instruction.	Pr	00000000h ~ FFFFFFFFh	-
PE70	PDAT34	PATH#34 data Please refer to PE04 instruction.	Pr	$-(2^{31}+1)$ ~ $-(2^{31}-1)$	-
PE71	PDEF35	PATH#35 definition Please refer to PE03 instruction.	Pr	00000000h ~ FFFFFFFFh	-
PE72	PDAT35	PATH#35 data Please refer to PE04 instruction.	Pr	$-(2^{31}+1)$ ~ $-(2^{31}-1)$	-
PE73	PDEF36	PATH#36 definition Please refer to PE03 instruction.	Pr	00000000h ~ FFFFFFFFh	-
PE74	PDAT36	PATH#36 data Please refer to PE04 instruction.	Pr	$-(2^{31}+1)$ ~ $-(2^{31}-1)$	-
PE75	PDEF37	PATH#37 definition Please refer to PE03 instruction.	Pr	00000000h ~ FFFFFFFFh	-
PE76	PDAT37	PATH#37 data Please refer to PE04 instruction.	Pr	$-(2^{31}+1)$ ~ $-(2^{31}-1)$	-
PE77	PDEF38	PATH#38 definition Please refer to PE03 instruction.	Pr	00000000h ~ FFFFFFFFh	-
PE78	PDAT38	PATH#38 data Please refer to PE04 instruction.	Pr	$-(2^{31}+1)$ ~ $-(2^{31}-1)$	-
PE79	PDEF39	PATH#39 definition Please refer to PE03 instruction.	Pr	00000000h ~ FFFFFFFFh	-
PE80	PDAT39	PATH#39 data Please refer to PE04 instruction.	Pr	$-(2^{31}+1)$ ~ $-(2^{31}-1)$	-
PE81	PDEF40	PATH#40 definition Please refer to PE03 instruction.	Pr	00000000h ~ FFFFFFFFh	-
PE82	PDAT40	PATH#40 data Please refer to PE04 instruction.	Pr	$-(2^{31}+1)$ ~ $-(2^{31}-1)$	-
PE83	PDEF41	PATH#41 definition Please refer to PE03 instruction.	Pr	00000000h ~ FFFFFFFFh	-
PE84	PDAT41	PATH#41 data Please refer to PE04 instruction.	Pr	$-(2^{31}+1)$ ~ $-(2^{31}-1)$	-

No	Abbr.	Function description	Control mode	Setting range	Unit
PE69	PDEF34	PATH#34 definition Please refer to PE03 instruction.	Pr	00000000h ~ FFFFFFFFh	-
PE70	PDAT34	PATH#34 data Please refer to PE04 instruction.	Pr	$-(2^{31}+1)$ $\sim$ $-(2^{31}-1)$	-
PE71	PDEF35	PATH#35 definition Please refer to PE03 instruction.	Pr	00000000h ~ FFFFFFFFh	-
PE72	PDAT35	PATH#35 data Please refer to PE04 instruction.	Pr	$-(2^{31}+1)$ $\sim$ $-(2^{31}-1)$	-
PE73	PDEF36	PATH#36 definition Please refer to PE03 instruction.	Pr	00000000h ~ FFFFFFFFh	-
PE74	PDAT36	PATH#36 data Please refer to PE04 instruction.	Pr	$-(2^{31}+1)$ $\sim$ $-(2^{31}-1)$	-
PE75	PDEF37	PATH#37 definition Please refer to PE03 instruction.	Pr	00000000h ~ FFFFFFFFh	-
PE76	PDAT37	PATH#37 data Please refer to PE04 instruction.	Pr	$-(2^{31}+1)$ $\sim$ $-(2^{31}-1)$	-
PE77	PDEF38	PATH#38 definition Please refer to PE03 instruction.	Pr	00000000h ~ FFFFFFFFh	-
PE78	PDAT38	PATH#38 data Please refer to PE04 instruction.	Pr	$-(2^{31}+1)$ $\sim$ $-(2^{31}-1)$	-
PE79	PDEF39	PATH#39 definition Please refer to PE03 instruction.	Pr	00000000h ~ FFFFFFFFh	-
PE80	PDAT39	PATH#39 data Please refer to PE04 instruction.	Pr	$-(2^{31}+1)$ $\sim$ $-(2^{31}-1)$	-
PE81	PDEF40	PATH#40 definition Please refer to PE03 instruction.	Pr	00000000h ~ FFFFFFFFh	-
PE82	PDAT40	PATH#40 data Please refer to PE04 instruction.	Pr	$-(2^{31}+1)$ $\sim$ $-(2^{31}-1)$	-
PE83	PDEF41	PATH#41 definition Please refer to PE03 instruction.	Pr	00000000h ~ FFFFFFFFh	-
PE84	PDAT41	PATH#41 data Please refer to PE04 instruction.	Pr	$-(2^{31}+1)$ $\sim$ $-(2^{31}-1)$	-

No	Abbr.	Function description	Control mode	Setting range	Unit
PE85	PDEF42	PATH#42 definition Please refer to PE03 instruction.	Pr	00000000h ~ FFFFFFFFh	-
PE86	PDAT42	PATH#42 data Please refer to PE04 instruction.	Pr	$-(2^{31}+1)$ $\sim(2^{31}-1)$	-
PE87	PDEF43	PATH#43 definition Please refer to PE03 instruction.	Pr	00000000h ~ FFFFFFFFh	-
PE88	PDAT43	PATH#43 data Please refer to PE04 instruction.	Pr	$-(2^{31}+1)$ $\sim(2^{31}-1)$	-
PE89	PDEF44	PATH#44 definition Please refer to PE03 instruction.	Pr	00000000h ~ FFFFFFFFh	-
PE90	PDAT44	PATH#44 data Please refer to PE04 instruction.	Pr	$-(2^{31}+1)$ $\sim(2^{31}-1)$	-
PE91	PDEF45	PATH#45 definition Please refer to PE03 instruction.	Pr	00000000h ~ FFFFFFFFh	-
PE92	PDAT45	PATH#45 data Please refer to PE04 instruction.	Pr	$-(2^{31}+1)$ $\sim(2^{31}-1)$	-
PE93	PDEF46	PATH#46 definition Please refer to PE03 instruction.	Pr	00000000h ~ FFFFFFFFh	-
PE94	PDAT46	PATH#46 data Please refer to PE04 instruction.	Pr	$-(2^{31}+1)$ $\sim(2^{31}-1)$	-
PE95	PDEF47	PATH#47 definition Please refer to PE03 instruction.	Pr	00000000h ~ FFFFFFFFh	-
PE96	PDAT47	PATH#47 data Please refer to PE04 instruction.	Pr	$-(2^{31}+1)$ $\sim(2^{31}-1)$	-
PE97	PDEF48	PATH#48 definition Please refer to PE03 instruction.	Pr	00000000h ~ FFFFFFFFh	-
PE98	PDAT48	PATH#48 data Please refer to PE04 instruction.	Pr	$-(2^{31}+1)$ $\sim(2^{31}-1)$	-
PE99		Reserved			

No	Abbr.	Function description	Control mode	Setting range	Unit
PF01	PDEF49	PATH#49 definition Please refer to PE03 instruction.	Pr	00000000h ~ FFFFFFFFh	-
PF02	PDAT49	PATH#49 data Please refer to PE04 instruction.	Pr	$-(2^{31}+1)$ ~ $-(2^{31}-1)$	-
PF03	PDEF50	PATH#50 definition Please refer to PE03 instruction.	Pr	00000000h ~ FFFFFFFFh	-
PF04	PDAT50	PATH#50 data Please refer to PE04 instruction.	Pr	$-(2^{31}+1)$ ~ $-(2^{31}-1)$	-
PF05	PDEF51	PATH#51 definition Please refer to PE03 instruction.	Pr	00000000h ~ FFFFFFFFh	-
PF06	PDAT51	PATH#51 data Please refer to PE04 instruction.	Pr	$-(2^{31}+1)$ ~ $-(2^{31}-1)$	-
PF07	PDEF52	PATH#52 definition Please refer to PE03 instruction.	Pr	00000000h ~ FFFFFFFFh	-
PF08	PDAT52	PATH#52 data Please refer to PE04 instruction.	Pr	$-(2^{31}+1)$ ~ $-(2^{31}-1)$	-
PF09	PDEF53	PATH#53 definition Please refer to PE03 instruction.	Pr	00000000h ~ FFFFFFFFh	-
PF10	PDAT53	PATH#53 data Please refer to PE04 instruction.	Pr	$-(2^{31}+1)$ ~ $-(2^{31}-1)$	-
PF11	PDEF54	PATH#54 definition Please refer to PE03 instruction.	Pr	00000000h ~ FFFFFFFFh	-
PF12	PDAT54	PATH#54 data Please refer to PE04 instruction.	Pr	$-(2^{31}+1)$ ~ $-(2^{31}-1)$	-
PF13	PDEF55	PATH#55 definition Please refer to PE03 instruction.	Pr	00000000h ~ FFFFFFFFh	-
PF14	PDAT55	PATH#55 data Please refer to PE04 instruction.	Pr	$-(2^{31}+1)$ ~ $-(2^{31}-1)$	-
PF15	PDEF56	PATH#56 definition Please refer to PE03 instruction.	Pr	00000000h ~ FFFFFFFFh	-
PF16	PDAT56	PATH#56 data Please refer to PE04 instruction.	Pr	$-(2^{31}+1)$ ~ $-(2^{31}-1)$	-

No	Abbr.	Function description	Control mode	Setting range	Unit
PF17	PDEF57	PATH#57 definition Please refer to PE03 instruction.	Pr	00000000h ~ FFFFFFFFh	-
PF18	PDAT57	PATH#57 data Please refer to PE04 instruction.	Pr	$-(2^{31}+1)$ ~ $-(2^{31}-1)$	-
PF19	PDEF58	PATH#58 definition Please refer to PE03 instruction.	Pr	00000000h ~ FFFFFFFFh	-
PF20	PDAT58	PATH#58 data Please refer to PE04 instruction.	Pr	$-(2^{31}+1)$ ~ $-(2^{31}-1)$	-
PF21	PDEF59	PATH#59 definition Please refer to PE03 instruction.	Pr	00000000h ~ FFFFFFFFh	-
PF22	PDAT59	PATH#59 data Please refer to PE04 instruction.	Pr	$-(2^{31}+1)$ ~ $-(2^{31}-1)$	-
PF23	PDEF60	PATH#60 definition Please refer to PE03 instruction.	Pr	00000000h ~ FFFFFFFFh	-
PF24	PDAT60	PATH#60 data Please refer to PE04 instruction.	Pr	$-(2^{31}+1)$ ~ $-(2^{31}-1)$	-
PF25	PDEF61	PATH#61 definition Please refer to PE03 instruction.	Pr	00000000h ~ FFFFFFFFh	-
PF26	PDAT61	PATH#61 data Please refer to PE04 instruction.	Pr	$-(2^{31}+1)$ ~ $-(2^{31}-1)$	-
PF27	PDEF62	PATH#62 definition Please refer to PE03 instruction.	Pr	00000000h ~ FFFFFFFFh	-
PF28	PDAT62	PATH#62 data Please refer to PE04 instruction.	Pr	$-(2^{31}+1)$ ~ $-(2^{31}-1)$	-
PF29	PDEF63	PATH#63 definition Please refer to PE03 instruction.	Pr	00000000h ~ FFFFFFFFh	-
PF30	PDAT63	PATH#63 data Please refer to PE04 instruction.	Pr	$-(2^{31}+1)$ ~ $-(2^{31}-1)$	-
PF31~ PF32		Reserved			

No	Abbr.	Function description	Control mode	Setting range	Unit
PF33	POV1	Inner position 1 velocity	Pr	1 ~6000	rpm
PF34	POV2	Inner position 2 velocity	Pr	1 ~6000	rpm
PF35	POV3	Inner position 3 velocity	Pr	1 ~6000	rpm
PF36	POV4	Inner position 4 velocity	Pr	1 ~6000	rpm
PF37	POV5	Inner position 5 velocity	Pr	1 ~6000	rpm
PF38	POV6	Inner position 6 velocity	Pr	1 ~6000	rpm
PF39	POV7	Inner position 7 velocity	Pr	1 ~6000	rpm
PF40	POV8	Inner position 8 velocity	Pr	1 ~6000	rpm
PF41	POV9	Inner position 9 velocity	Pr	1 ~6000	rpm
PF42	POV10	Inner position 10 velocity	Pr	1 ~6000	rpm
PF43	POV11	Inner position 11 velocity	Pr	1 ~6000	rpm
PF44	POV12	Inner position 12velocity	Pr	1 ~6000	rpm
PF45	POV13	Inner position 13 velocity	Pr	1 ~6000	rpm
PF46	POV14	Inner position 14 velocity	Pr	1 ~6000	rpm
PF47	POV15	Inner position 15 velocity	Pr	1 ~6000	rpm
PF48	POV16	Inner position 16 velocity	Pr	1 ~6000	rpm

No	Abbr.	Function description	Control mode	Setting range	Unit
PF49	POA1	Inner position 1 acc./dec. time	Pr	1 ~65550	ms
PF50	POA2	Inner position 2 acc./dec. time	Pr	1 ~65550	ms
PF51	POA3	Inner position 3 acc./dec. time	Pr	1 ~65550	ms
PF52	POA4	Inner position 4 acc./dec. time	Pr	1 ~65550	ms
PF53	POA5	Inner position 5 acc./dec. time	Pr	1 ~65550	ms
PF54	POA6	Inner position 6 acc./dec. time	Pr	1 ~65550	ms
PF55	POA7	Inner position 7 acc./dec. time	Pr	1 ~65550	ms
PF56	POA8	Inner position 8 acc./dec. time	Pr	1 ~65550	ms
PF57	POA9	Inner position 9 acc./dec. time	Pr	1 ~65550	ms
PF58	POA10	Inner position 10 acc./dec. time	Pr	1 ~65550	ms
PF59	POA11	Inner position 11 acc./dec. time	Pr	1 ~65550	ms
PF60	POA12	Inner position 12 acc./dec. time	Pr	1 ~65550	ms
PF61	POA13	Inner position 13 acc./dec. time	Pr	1 ~65550	ms
PF62	POA14	Inner position 14 acc./dec. time	Pr	1 ~65550	ms
PF63	POA15	Inner position 15 acc./dec. time	Pr	1 ~65550	ms
PF64	POA16	Inner position 16 acc./dec. time	Pr	1 ~65550	ms

No	Abbr.	Function description	Control mode	Setting range	Unit
PF65	DLY1	Inner position 1 completion delay time	Pr	0 ~32767	ms
PF66	DLY2	Inner position 2 completion delay time	Pr	0 ~32767	ms
PF67	DLY3	Inner position 3 completion delay time	Pr	0 ~32767	ms
PF68	DLY4	Inner position 4 completion delay time	Pr	0 ~32767	ms
PF69	DLY5	Inner position 5 completion delay time	Pr	0 ~32767	ms
PF70	DLY6	Inner position 6 completion delay time	Pr	0 ~32767	ms
PF71	DLY7	Inner position 7 completion delay time	Pr	0 ~32767	ms
PF72	DLY8	Inner position 8 completion delay time	Pr	0 ~32767	ms
PF73	DLY9	Inner position 9 completion delay time	Pr	0 ~32767	ms
PF74	DLY10	Inner position 10 completion delay time	Pr	0 ~32767	ms
PF75	DLY11	Inner position 11 completion delay time	Pr	0 ~32767	ms
PF76	DLY12	Inner position 12 completion delay time	Pr	0 ~32767	ms
PF77	DLY13	Inner position 13 completion delay time	Pr	0 ~32767	ms
PF78	DLY14	Inner position 14 completion delay time	Pr	0 ~32767	ms
PF79	DLY15	Inner position 15 completion delay time	Pr	0 ~32767	ms
PF80	DLY16	Inner position 16 completion delay time	Pr	0 ~32767	ms



No	Abbr.	Function description	Control mode	Setting range	Unit																								
PF81	PDEC	<p>Protection trigger deceleration time The bit definition of PF81 is described as follows.</p> <table border="1" style="margin-left: 20px;"> <thead> <tr> <th colspan="8">PF81</th> </tr> <tr> <th>31~28</th> <th>27~24</th> <th>23~20</th> <th>19~16</th> <th>15~12</th> <th>11~8</th> <th>7~4</th> <th>3-0</th> </tr> </thead> <tbody> <tr> <td>STP</td> <td>-</td> <td>CTO</td> <td>-</td> <td>SNL</td> <td>SPL</td> <td>NL</td> <td>PL</td> </tr> </tbody> </table> <p>STP: The secondary deceleration time for home moving CTO: Communication time-out, ABS error deceleration time SNL: Software reverse stroke limit trigger deceleration time SPL: Software forward stroke limit trigger deceleration time NL : LSN trigger deceleration time PL : LSP trigger deceleration time The choice of PF49 to PF 64 is assigned to 0~F bit value.</p>	PF81								31~28	27~24	23~20	19~16	15~12	11~8	7~4	3-0	STP	-	CTO	-	SNL	SPL	NL	PL	Pt, Pr S,T	0 ~ F0F0FFFFh	-
PF81																													
31~28	27~24	23~20	19~16	15~12	11~8	7~4	3-0																						
STP	-	CTO	-	SNL	SPL	NL	PL																						
PF82	PRCM	<p>PR trigger register To write 0 into PF82 to execute "origin return". To write 1~63 into PF82 to execute PATH#1~PATH#63 64~999 is prohibited to write into PF82. To write 1000 into PF82 to execute "stop"</p> <p>The read value of PF82 indicates the executed PATH situation. To write 3 into PF82 to executed PATH#3 is as an example: 3: means that PATH#3 is being executed 1003: means that PATH#3 command is completed 2003: means that PATH#3 positioning is done</p>	Pr	0 ~1000	-																								
PF83	EVON	<p>Event raising trigger</p> <table border="1" style="margin-left: 20px;"> <thead> <tr> <th colspan="4">PF83</th> </tr> <tr> <th>15~12</th> <th>11~8</th> <th>7~4</th> <th>3~0</th> </tr> </thead> <tbody> <tr> <td>U</td> <td>Z</td> <td>Y</td> <td>X</td> </tr> </tbody> </table> <p>X=0: EV1 is invalid X=1~D: To execute PATH#51~63 when EV1 is activated Y=0: EV2 is invalid Y=1~D: To execute PATH#51~63 when EV2 is activated Z=0: EV3 is invalid Z=1~D: To execute PATH#51~63 when EV1 is activated U=0: EV4 is invalid U=1~D: To execute PATH#51~63 when EV4 is activated</p>	PF83				15~12	11~8	7~4	3~0	U	Z	Y	X	Pr	0000h ~DDDDh	-												
PF83																													
15~12	11~8	7~4	3~0																										
U	Z	Y	X																										
PF84	EVOF	<p>Event falling trigger PF84 makes the PATH#51~63 be executed when EV1~4 is disabled. Refer to the description of PF83.</p>	Pr	0000h ~DDDDh	-																								
PF85	PMEM	<p>PATH#1 to PATH#2 memory invalid</p> <table border="1" style="margin-left: 20px;"> <tr> <td>0</td> <td>0</td> <td>y</td> <td>x</td> </tr> </table> <p><u>x: PATH#1 memory option</u> 0: memory is hold when drive is power off 1: memory is not hold when drive is power off <u>y: PATH#2 memory option</u> 0: memory is hold when drive is power off 1: memory is not hold when drive is power off</p>	0	0	y	x	Pt, Pr S,T	0000h ~0011h	-																				
0	0	y	x																										

No	Abbr.	Function description	Control mode	Setting range	Unit
PF86	SWLP	Software forward stroke limit When Pr or Pt absolute system is applied, if the position command pulses exceed the PF86 setting value, AL.14 would be occurred. ※: position command means the original format which before electronic gear ratio process	Pt, Pr	$-(2^{31}+1)$ $\sim(2^{31}-1)$	pulse
PF87	SWLN	Software reverse stroke limit When Pr or Pt absolute system is applied, if the position command pulses exceed the PF86 setting value, AL.15 would be occurred. ※: position command means the original format which before electronic gear ratio process	Pt, Pr	$-(2^{31}+1)$ $\sim(2^{31}-1)$	Pulse
PF88	KNBR	Tool quantity of turret Used to define the tool quantity of user's turret, the quantity is depended on various mechanisms.	Turret	0 $\sim 32767$	ms
PF89~PF90		Reserved			

### Digital input(DI) function definition

Sign	Setting Value	Functions/Applications description
SON	0x01	Power on the drive and activate SON to magnetize the motor shaft.
RES	0x02	Use this RES to recover the servo drive normal status.
PC	0x03	To switch proportion-integral speed control to proportion one.
TL	0x04	To switch torque limit from inner limit 1 to external analog limit.
TL1	0x05	Activate TL1 to make inner torque limit 2 valid.
SP1	0x06	Activate SP1 to select the specific speed command.
SP2	0x07	Activate SP2 to select the specific speed command.
SP3	0x08	Activate SP2 to select the specific speed command.
ST1/RS2	0x09	Speed mode: The motor will rotate in CCW when the signal is activated. Torque mode: The motor will rotate in CW when the signal is activated.
ST2/RS1	0x0A	Speed mode: The motor will rotate in CW when the signal is activated. Torque mode: The motor will rotate in CCW when the signal is activated.
ORGP	0x0B	In position control with inner registers, the arbitrary position could be assigned as the origin when this signal activated.
SHOM	0x0C	As this signal activated, the drive runs motor to return the present origin.
CM1	0x0D	Electronic gear numerator option 1
CM2	0x0E	Electronic gear numerator option 2
CR	0x0F	Used to clear the position command pulse errors on its rising edge.
CDP	0x10	Turn CDP on to change the gain into the multiplier of PB14 to PB17.
LOP	0x11	It is used to switch varied mode as hybrid control mode applied.
EMG	0x12	Turn it off to bring to an emergency stop and turn it on to reset that state.

Sign	Setting Value	Functions/Applications description
POS1	0x13	Activate POS1 to select the specific position command when the inner position mode is applied.
POS2	0x14	Activate POS2 to select the specific position command when the inner position mode is applied.
POS3	0x15	Activate POS3 to select the specific position command when the inner position mode is applied.
CTRG	0x16	Trigger this signal to execute the inner position command.
HOLD	0x17	In position control with inner registers (Pr), the motor would stop running when this signal is activated.
LSP	0x18	Activate LSP to recover from AL13 and make the position or speed mode could be performed.
LSN	0x19	Activate LSN to recover from AL13 and make the position or speed mode could be performed.
POS4	0x1A	Activate POS4 to select the specific position command when the inner position mode is applied.
POS5	0x1B	Activate POS5 to select the specific position command when the inner position mode is applied.
POS6	0x1C	Activate POS6 to select the specific position command when the inner position mode is applied.
INHP	0x1D	Activate INHP to make the external position pulse command invalid.
EV1	0x1E	<p>There are 4 events with rising or falling edges can be set to trigger a specific PR command.</p> <p>EV□: Trigger the command by changing the DI status.  □=1, 2, 3, 4</p> <p>PF83: Event Rising-edge Trigger Command (OFF → ON)  PF84: Event Falling-edge Trigger Command (ON → OFF)</p> <p>Suitable case: sensor, preset trigger procedure</p>
EV2	0x1F	
EV3	0x20	
EV4	0x21	
ABSE	0x22	Activate ABSE to initialize an absolute system with the specific PLC.
ABSC	0x23	Activate ABSC to reset the pulse number of absolute encoder to be zero.
STOP	0x24	Activate STOP to stop the motor running.

## Digital output (DO) function definition

Sign	Setting Value	Functions/Applications description
RD	0x01	After enabling the servo drive ready to operate, RD will be turn on.
ALM	0x02	When an alarm occurs, ALM will turn off. When an alarm does not occur, ALM will turn on after power on 1 second later.
INP/SA	0x 03	In position mode, INP-SG is conductive as position errors is under permissible range. In speed mode, SA-SG is conductive as the motor speed has nearly attained.
HOME	0x 04	HOME-SG is on after the completion of home moving.
TLC/VLC	0x 05	In speed mode, TLC-SG is on as motor generated torque reaches inner torque limit or torque analog limit. TLC-SG is off when SON signal is turned off.  In torque mode, VLC-SG is on as motor speed reaches inner speed limit or speed analog limit. VLC-SG is off when SON signal is turned off.
MBR	0X06	When using this signal, make it usable by setting parameter PA01 as <input type="checkbox"/> 1 <input type="checkbox"/> <input type="checkbox"/> . MBR is off as the power is turned off or any alarm occurred.
WNG	0x 07	WNG-SG is conductive as any warning occurred. Without warning occurring, WNG-SG is isolated.
ZSP	0x 08	When motor speed is under the preset of zero speed, ZSP-SG keeps conductive.
CMDOK	0x 09	CMDOK-SG is conductive as the inner position command is completed or stopped.
OLW	0x0A	OLW is conductive when the servo drive has detected that the motor has reached the output overload level.
MC_OK	0x0B	MC_OK is conductive when CMDOK and INP are both ON. If only CMDOK or INP is ON, MC_OK will not be activated.
OVF	0x0C	OVF is conductive when the servo drive has detected that an inner position command overflows.
SWPL	0x0D	SWPL is conductive when the motor feedback pulses have reached the software positive limit.
SWNL	0x0E	SWNL is conductive when the motor feedback pulses have reached the software negative limit.
ABSW	0x0F	The fault messages regarding the absolute encoder will be output via ABSW.

## 6. Gain adjustment and control mode



### CAUTION

- The extreme adjustments will your machine vibrate or operate unexpectedly.
- Make the adjustment with a safety margin, a maximum 90% generated torque is recommended.

### 6.1. Different adjustment methods

The following table shows the gain adjustment methods that are varies according to the PA02 setting. For gain adjustment, first execute "Auto tuning mode 1". If you are not satisfied with the result, try "Auto tuning mode 2" then "Manual mode" step by step.

(1) Gain adjustment mode explanation

Gain tuning mode	PA02 setting	Estimation rule	Automatically set parameter	Manually set parameter
Manual gain tuning mode 1 (PI control)	0000h	A fixed PB06.	/	GD1(PB06) PG1 (PB07) VG1 (PB08) VIC (PB09)
Manual gain tuning mode 2 (PI control + interference compensator)	0001h			GD1(PB06) PG1 (PB07) VG1 (PB08) VIC (PB09)
Auto-gain tuning mode 1	0002h	Always estimated.	GD1(PB06) PG1 (PB07) VG1 (PB08) VIC (PB09)	ATUL(PA03)
Auto-gain tuning mode 2	0003h	A fixed PB06.	PG1 (PB07) VG1 (PB08) VIC (PB09)	ATUL(PA03) GD1(PB06)
Interpolation mode	0004h	Always estimated.	GD1(PB06) VG1 (PB08) VIC (PB09)	ATUL(PA03) PG1(PB07)

The PA02 is not changeable when the SON is activated. Make the SON signal invalid then set the proper values.

(2) Gain adjustment flowchart

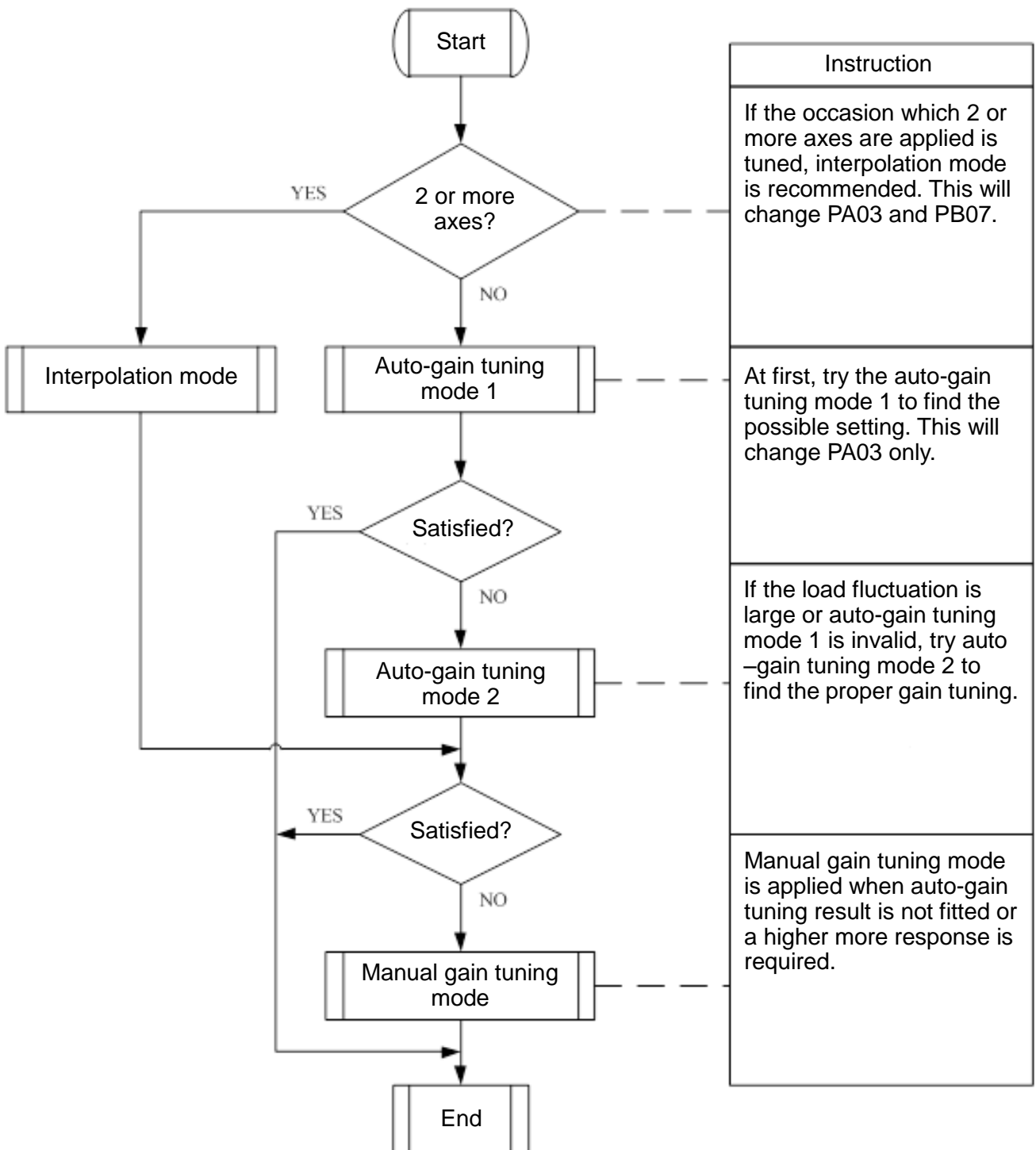

If the mechanical system which being tuned is a new set up, please use the JOG test at first. As no abnormal alarm occurred then use the auto-gain tuning function. During the auto-gain tuning function operated, several routes of acceleration and deceleration are necessary to make the ratio of load inertia to motor shaft be getting stable. Finally, the proper gain and response would be set.

## 6.2. Auto-gain tuning mode

The auto-gain tuning mode can calculate the load to motor inertia ratio instantaneously. With this value, the optimum gain could be decided under the current mechanical condition. It is convenient to execute the adjustment of gain value with the auto-gain tuning function.

### (1) Auto-gain tuning mode 1

This mode is a default. If the PA02 is set as "0002h", the load to motor inertia ratio would be approximated continuously and the servo gain will be set automatically. The variable parameter for users is only PA03 which the response setting related.

NO.	Abbr.	Name	Operation
PA03	ATUL	Auto-tuning response level setting	User adjustable
PB06	GD1	Load to motor inertia ratio	auto-approximated
PB07	PG1	Position loop gain	auto-approximated
PB08	VG1	Speed loop gain	auto-approximated
PB09	VIC	Speed integral gain	auto-approximated

When the auto-gain tuning mode 1 is applied, some conditions must be met.

- a. The acceleration time from 0rpm to 2000rpm or the deceleration time from 2000rpm to 0rpm should be 2 seconds or less. If a 3000rpm case is applied, the acceleration and deceleration time should be 3 seconds or less.
- b. The speed command should be 250rpm or higher.
- c. The load to motor inertia ratio should be 100 times or less.
- d. A machinery system with a violent change of load inertia is not suitable.
- e. Torque generated due to acceleration or deceleration should be the 10% or more of rated torque.

### (2) Auto-gain tuning mode 2

When auto-gain tuning mode 1 could not calculate the accurate load to motor inertia ratio, the auto-gain tuning mode 2 is recommended. The PA02 should be set as "0003h" to perform. During the tuning process, the load to motor inertia ratio would not be approximated and the users have to set the PB06 manually.

NO.	Abbr.	Name	Operation
PA03	ATUL	Auto-tuning response level setting	User adjustable
PB06	GD1	Load to motor inertia ratio	User adjustable
PB07	PG1	Position loop gain	auto-approximated
PB08	VG1	Speed loop gain	auto-approximated
PB09	VIC	Speed integral gain	auto-approximated



### (3) Auto tuning sequence

The flow of auto-gain tuning mode is presented below.

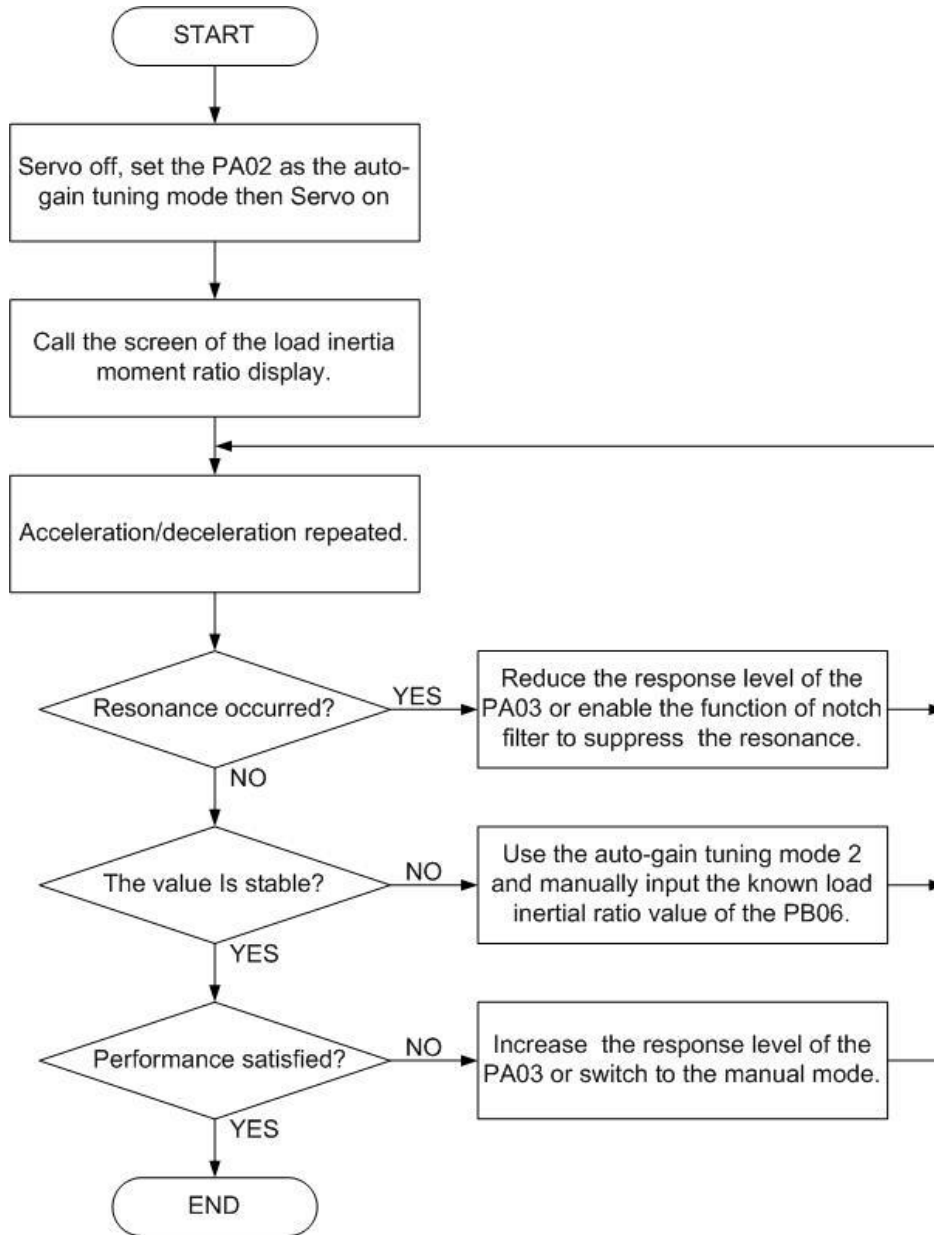

When auto-gain tuning mode is performed, the following conditions should be satisfied.

- First, execute the acceleration/deceleration cyclic stroke; load to motor inertia ratio would be approximated after 2~3 strokes. The new PB06 would be updated to EEPROM.
- Auto-gain tuning mode 2 is applied when the PB06 is known. Under this mode, the estimation of control gain would still compute.
- With the settings of inertia ratio and response level, the servo drive would tune the optimum gains during the acceleration/deceleration stroke. The result of gain tuning would be written into EEPROM every 30 minutes. After power on, the saved value of the controller gain in the EEPROM would be used as the initial value for the operation of auto-gain tuning mode.

(4) Auto tuning response level

The PA03 is related to the response of the whole servo system. As the response level setting is increased, the traceability and settling time for a command decreases, but a too high response level setting would generate vibration. Therefore, keep setting until the optimum response is obtained within the range without vibration.

If the response level setting which user desired would cause machine resonance, the machine resonance suppression filter (PB01, PB02, PB21, PB22) and the resonance suppression low-pass filter (PB03) could be employed to suppress machine resonance. Suppressing machine resonance may allow the response level setting to be higher.

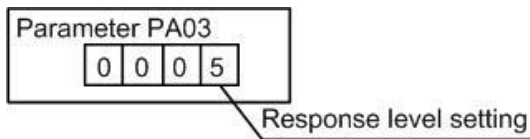

Response level setting	Machine rigidity	Speed response frequency (Hz)	
1	Low	10.0	
2		11.3	
3		12.7	
4		14.3	
5		16.1	
6		18.1	
7		20.4	
8		23.0	
9		25.9	
10		29.2	
11		32.9	
12		37.0	
13		41.7	
14		47.0	
15	Middle	52.9	
16		59.6	
17		High	67.1
18			75.6
19			85.2
20			95.9
21			108.0
22			121.7
23	137.1		
24	154.4		
25	173.9		
26	195.9		
27	220.6		
28	248.5		
29	279.9		
30	315.3		
31	355.1		
32	400.0		

For the response level setting, it is recommended to use the level value from low response to high response gradually. It is probable to make resonance if the initial value is too high.

The applicable ratio of load inertia to motor shaft is a reference. The actual range would vary with the different mechanical systems.

### 6.3. Manual gain tuning mode

The manual gain tuning mode is executed when the result of auto-gain tuning is not suitable for the user's demand.

For the applications of position control or speed control, the bandwidth is highly related with the machinery rigidity. For machine tools which the high precision required, a high bandwidth system response is necessary. However, a high response level setting could cause the machine resonance easily. Therefore, a high rigidity machine should be used for occasions that require a high response to avoid machine resonance.

If users have no idea about the permissible response of the machine, they should adopt a smaller gain value at first and then gradually increase the gain values until machine resonance occurred. Then users could reduce the gain values accordingly. Reference parameter values for users to adjust are listed in the following table:

Name	Name Abbr.	Sign	Setting range	Unit	Default	Control mode
Resonance suppression low-pass filter	NLP	PB03	0~10000	0.1mS	0	ALL
Position feed-forward gain	FFC	PB05	0~200	%	0	Pt, Pr,
Load to motor inertia ratio	GD1	PB06	0~1200	0.1time	70	ALL
Position loop gain	PG1	PB07	4~1024	rad/s	45	Pt, Pr
Speed loop gain	VG1	PB08	40~9000	rad/s	183	Pt, Pr, S
Speed integral gain	VIC	PB09	1~1000	ms	34	Pt, Pr, S
Speed feed-forward gain	VFG	PB10	0~200	%	0	Pt, Pr, S

➤ Position loop gain (PG1)

This parameter determines the response level of the position loop. Increasing PG1 improves traceability, settling time and position error but a too high value will make overshooting or vibration.

$$PG1 \text{ setting value} \leq \frac{VG1 \text{ setting value}}{1 + \text{ratio of load inertial to motor shaft}} \times \frac{1}{4}$$

$$PG1 \text{ setting value} \approx \text{speed loop bandwidth} \times \frac{1}{4}$$

➤ Speed loop gain (VG1)

This parameter determines the response level of the speed loop. Increasing VG1 improves traceability to a speed command but a too high value will make machine resonance. The Speed loop gain is usually 4~6 times bigger than the position loop gain. As the position loop gain is greater than the speed loop gain, machine resonance or overshoot would be occurred easily.

$$\text{Speed loop response frequency(Hz)} = \frac{VG1 \text{ setting value}}{(1 + \text{ratio of load inertial to motor shaft}) \times 2\pi}$$

➤ Speed integral gain (VIC)

This parameter is to eliminate stationary deviation against a command. The smaller it is, the better capability for the drive to eliminate stationary deviation. However, the machine with a large load inertia ratio or any vibration causing, the small value would cause vibration easily.

$$VIC \text{ setting value}(ms) \geq \frac{3000 \sim 5000}{VG1 \text{ setting value} / (1 + GD1 \text{ setting value} \times 0.1)}$$

➤ Resonance suppression low-pass filter (NLP)

The larger the load inertia ratio is, the lower the system bandwidth is. To keep a relatively high bandwidth, a higher gain value may be required. Also the probability of resonance for the same machine would be increased. Thus the resonance suppression low-pass filter could be applied to eliminate the resonance. The higher setting value affords a better improvement about high frequency noises. Also a too large value could probably cause the entire system to be instable. It is because the higher setting value cause a larger phase lags of the servo drive.

$$VIC \text{ setting value}(ms) \geq \frac{3000 \sim 5000}{VG1 \text{ setting value} / (1 + GD1 \text{ setting value} \times 0.1)}$$

➤ Position feed-forward gain (FFC)

To reduce the position error and position settling time, but if the value is set too large, a sudden acceleration or deceleration may cause overshoots. Also, a too large electronic gear ratio would cause noises.

➤ Speed feed-forward gain (VFG)

To set the proper gain value would reduce the tracking time of speed command. Also, a too big value would cause overshoots during the sudden acceleration/deceleration command.

## 6.4. Interpolation mode

This mode is suitable for the occasion where 2 or more axes are controlled synchronously. Only PB07 (PG1) needs to be input manually, other gain parameters are estimated automatically. Increasing the PB07 will reduce the tracking time or settling time. Also, a too big value would cause overshoots or vibration. Please refer to the previous section to calculate the PB07.

## 6.5. Torque control mode

Torque mode is often applied for such occasions: winding machines, printing press, injection molding machines, etc. The torque command is an analog voltage signals to control the generated torque. The basic torque control blocks are shown as below.

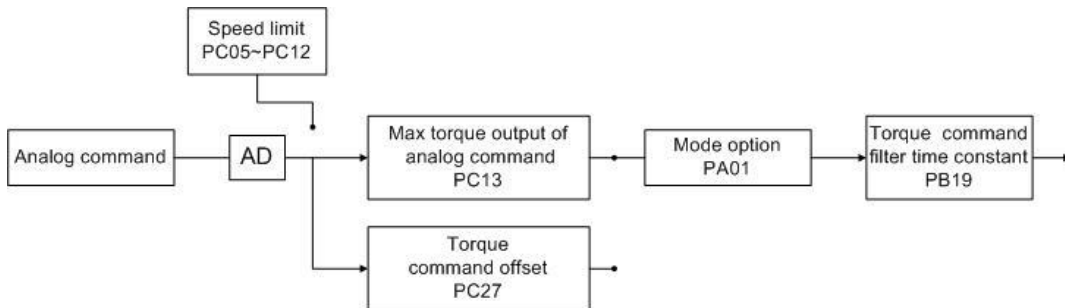

### 6.5.1. Output proportion of maximum torque analog command

Output proportion is the relationship between the applied voltage of the torque analog command and the torque generated by the servo motor.

Name	Sign	Setting range	Unit	Default	Control mode
Torque generated of maximum analog command	PC13	0~2000	%	100	ALL

If the setting value of PC13 is 100%, the 100% rated torque of servo motor would be generated when the applied voltage of torque command is 10V. If the applied voltage of torque command is 5V, the generated torque would be the 50% rated torque. The conversion is listed as follows.

$$\text{The generated torque(\%)} = \frac{\text{applied voltage of torque command}}{10} \times \text{the setting value of PC13}$$

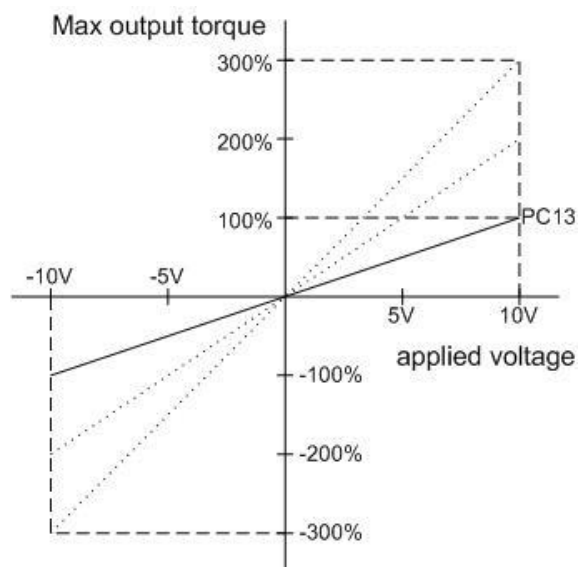

### 6.5.2. Torque analog command offset

When the torque analog command is 0V, there may be still a offset voltage which will cause a slow motor rotation. In such case, the user could use the parameter PC27 to correct the bias voltage.

The parameter description is as follows.

Name	Sign	Setting range	Unit	Default	Control mode
Torque analog command offset	PC27	-8000 ~ 8000	mV	0	S,T

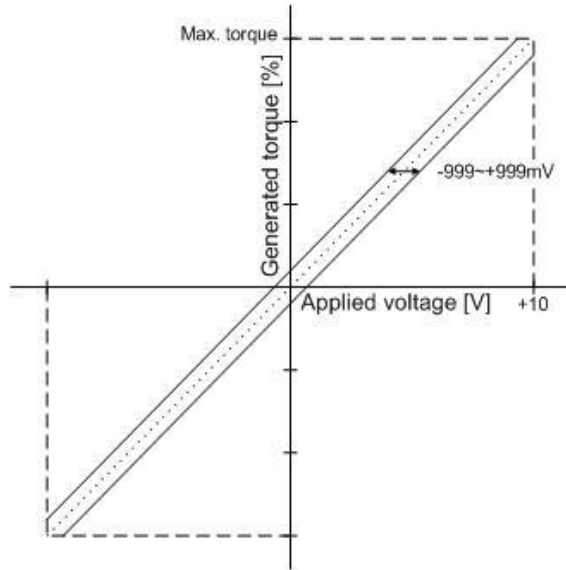

### 6.5.3. Torque analog command smoothing

By setting the filter time constant of torque analog command, the user could run the servo motor smoothly in response to a sudden torque command. The parameter description is as follows.

Name	Sign	Setting range	Unit	Default	Control mode
Torque command filter time constant	PB19	0~5000	ms	0	T

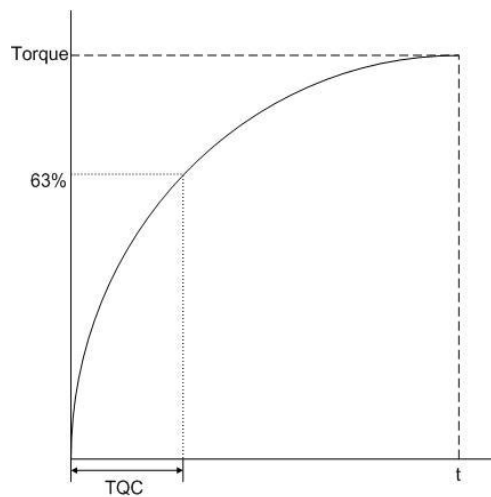

#### 6.5.4. Torque limit of torque control mode

The PA05 and PC25 are used to limit the generated torque of servo motor when the torque control mode is performed. The description is as follows.

Name	Name Abbr.	Sign	Setting range	Unit	Default	Control mode
Inner torque limit 1 [%]	TL1	PA05	0~100	%	100	ALL
Inner torque limit 2 [%]	TL2	PC25	0~100	%	100	ALL

The TL1 signal function of CN1 is also described again as follows.

Name	Name Abbr.	Description	Control mode
Inner torque limit option	TL1	When this signal is applied, make the PD02 to PD09 usable at first. Open TL1-SG to make inner torque limit 2 valid (PC25).	ALL

There are two different results which are chosen by the switch status of DI.

DI signal status(*)	The valid value of torque limit
TL1	
0	The setting value of PA05
1	If the PC25 is greater than the PA05, the PA05 is valid. If the PC25 is less than the PA05, the PC25 is valid.

(\*) 0: OFF(TL1-SG is open-circuit) 1: ON (TL1-SG is short-circuit)

### 6.5.5. Speed limit of torque control mode

Under the torque control mode, the various speed limits could be applied by the SP1, SP2, SP3 and the external analog signal. There are 8 combinations which are listed below for user to choose.

DI status	Valid option	DI signal status(*)			Speed limit	Limit range	Related parameter
		SP2	SP1				
SP3 is invalid (default value)	VCM	0	0		Speed analog limit(VC)	±10V	PC12
	SC1	0	1		Inner speed limit 1	-6000 ~ 6000	PC05
	SC2	1	0		Inner speed limit 2		PC06
	SC3	1	1		Inner speed limit 3		PC07
SP3 is valid	Valid option	SP3	SP2	SP1	Speed limit	Limit range	Related parameter
	VCM	0	0	0	Speed analog limit(VC)	±10V	PC12
	SC1	0	0	1	Inner speed limit 1	-6000 ~ 6000	PC05
	SC2	0	1	0	Inner speed limit 2		PC06
	SC3	0	1	1	Inner speed limit 3		PC07
	SC4	1	0	0	Inner speed limit 4		PC08
	SC5	1	0	1	Inner speed limit 5		PC09
	SC6	1	1	0	Inner speed limit 6		PC10
SC7	1	1	1	Inner speed limit 7	PC11		

(\*) 0: OFF (SPx-SG is open-circuit) 1: ON (SPx-SG is short-circuit) x=1,2,3

- ◆ When the external speed analog limit is applied, check the initial 0 voltage and PC12 value which are not permissible to exceed the motor's rated speed otherwise damages would be caused.
- ◆ To make the SP3 of DI valid by setting PD02 to PD09 if the option SC4 to SC7 are used.

The parameters related to the function of inner speed limit are described below.

Name	Sign	Setting range	Default	Control mode
Inner speed limit 1 [rpm]	PC05	0 ~ instant permissible speed	100	T
Inner speed limit 2 [rpm]	PC06		500	
Inner speed limit 3 [rpm]	PC07		1000	
Inner speed limit 4 [rpm]	PC08		200	
Inner speed limit 5 [rpm]	PC09		300	
Inner speed limit 6 [rpm]	PC10		500	
Inner speed limit 7 [rpm]	PC11		800	



## 6.6. Speed control mode

Speed control is often applied for occasions where is CNC machine, drilling machine, etc. The command source is analog signal or inner register. The analog signal is the external voltage. The inner command is performed by the following 2 ways: (1) Use the inner registers (PC05 to PC11) to set the various commands then switch SP1, SP2, and SP3 to change the demand speed. (2) Use the communication software to modify the value of speed command register.

To avoid the discontinuity, the drives afford users the smooth S-pattern running. There are 2 control modes (manual and automatic) available. The manual mode enables users to set all related parameters while the automatic functions were off. The automatic mode provides an estimation of load inertia ratio and parameters adjusted. In addition, an simple mode is designed to provide users a robust control which could instantaneously suppress external load interference. The basic speed control blocks are shown as below.

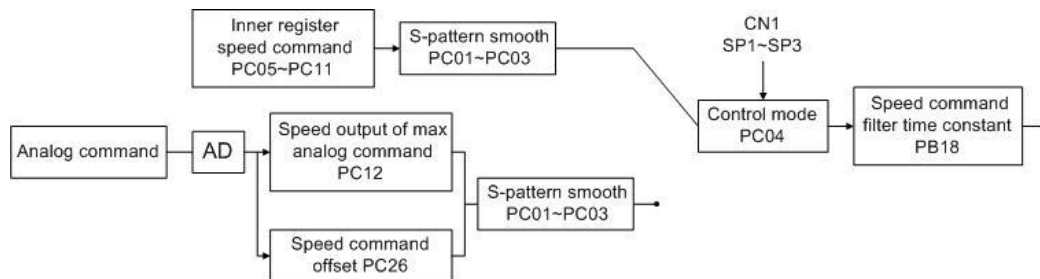

The S-pattern smooth process and speed filter are recommended to suppress the discontinuity.

### 6.6.1. Selection of speed command

There are 8 combinations which are listed below for user to choose.

DI status	Valid option	DI signal status(*)			Speed command	Setting range	Related parameter
		SP2	SP1				
SP3 is invalid (default value)	VCM	0	0		Analog Command(VC)	±10V	PC12
	SC1	0	1		Inner speed command 1	-6000 ~ 6000	PC05
	SC2	1	0		Inner speed command 2		PC06
	SC3	1	1		Inner speed command 3		PC07
SP3 is valid	Valid option	SP3	SP2	SP1	Speed command	Setting range	Related parameter
	VCM	0	0	0	Analog Command(VC)	±10V	PC12
	SC1	0	0	1	Inner speed command 1	-6000 ~ 6000	PC05
	SC2	0	1	0	Inner speed command 2		PC06
	SC3	0	1	1	Inner speed command 3		PC07
	SC4	1	0	0	Inner speed command 4		PC08
	SC5	1	0	1	Inner speed command 5		PC09
	SC6	1	1	0	Inner speed command 6		PC10
SC7	1	1	1	Inner speed command 7	PC11		

(\*) 0: OFF (SCx-SG is open-circuit) 1: ON (SCx-SG is short-circuit), x=1~7

### 6.6.2. Output speed of maximum speed analog command

The relationship between the applied voltage of the speed analog command and the output speed is described below.

Name	Sign	Setting range	Unit	Default	Control mode
Output speed of maximum analog voltage command	PC12	0~30000	rpm	3000	S,T

This value decides the output speed while the maximum permissible voltage is applied. If the PC12 is 3000, the motor would rotate at 3000rpm when the applied voltage of speed command is 10V. If the applied voltage of speed command is 5V, the rotary speed would be 1500rpm. The conversion is listed as follows.

$$\text{The output speed[rpm]} = \frac{\text{applied voltage of speed command}}{10} \times \text{the setting value of PC12}$$

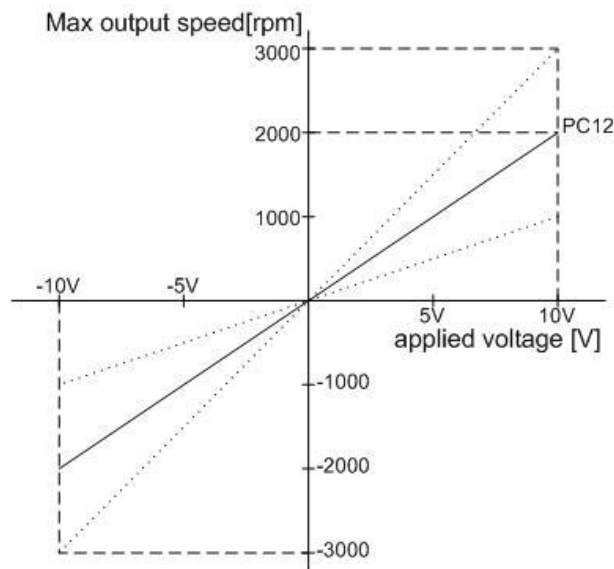

### 6.6.3. Speed analog command smoothing

If the speed command changed violently, vibration or noise or even overshoot may be occurred by the motor. Users could use related parameters for smoothing process to suppress those impacts. The acceleration time constant could be used to adjust the slope of speed pattern from static state to the speed command set by the user. The deceleration time constant could be used to adjust the slope from the rotary state to the static state. The S-pattern acceleration/deceleration time constant could be used to adjust the stability when starting or stopping the motor.

Name	Name Abbr.	Sign	Setting range	Unit	Default	Control mode
Acceleration time constant [ms]	STA	PC01	0~20000	ms	200	Pr, S, T
Deceleration time constant [ms]	STB	PC02	0~20000	ms	200	Pr, S, T
S-pattern acc./dec. time constant [ms]	STC	PC03	0~20000	ms	0	Pr, S, T

### Acceleration time constant

This parameter is the time spent for the motor from 0 rpm to the rated speed and it is defined as “acceleration time constant”. For example, if the rated speed of the servo motor is 3000 rpm and this parameter is set as 3000 (3s). In such case, the motor accelerating from 0 rpm to 3000 rpm would take 3 seconds. When the speed command is set as 1000 rpm, the motor take 1 second to accelerate from 0 rpm to 1000 rpm.

### Deceleration time constant

The time spent for the motor to decelerate from the rated speed to 0 rpm is called “deceleration time constant”. For example, if the current speed of the servo motor is 2000 rpm and this parameter is set as 4000 (4s). In such case, the motor decelerating from 2000 rpm to 0 rpm would take 2 second. When the running speed is 4000 rpm, the motor take 4 second to decelerate from 4000 rpm to 0 rpm.

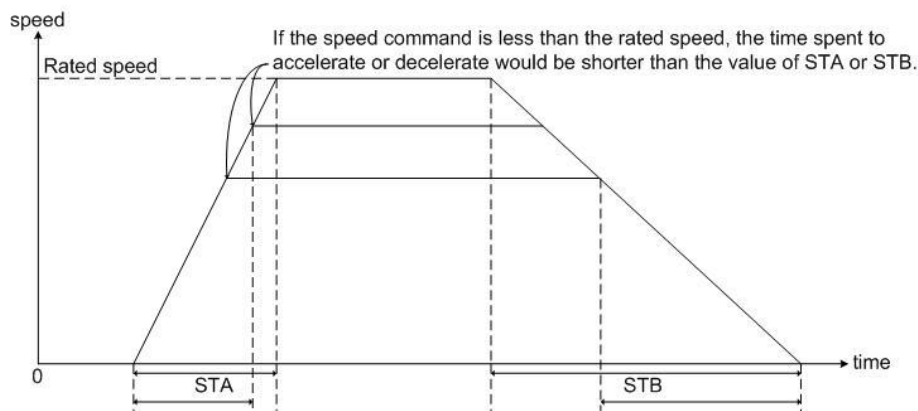

### S-pattern acc./dec. time constant

The method of S-pattern acceleration/deceleration time constants is to employ a three-step curve during the acceleration or deceleration process in order to soothe the vibration during starting or stopping the motor. Setting an appropriate STC could improve the stability of the motor during startup and stop. The initial S-pattern acceleration/deceleration constants are set as 0 second. Users are recommended to enable this function when the speed control mode is performed.

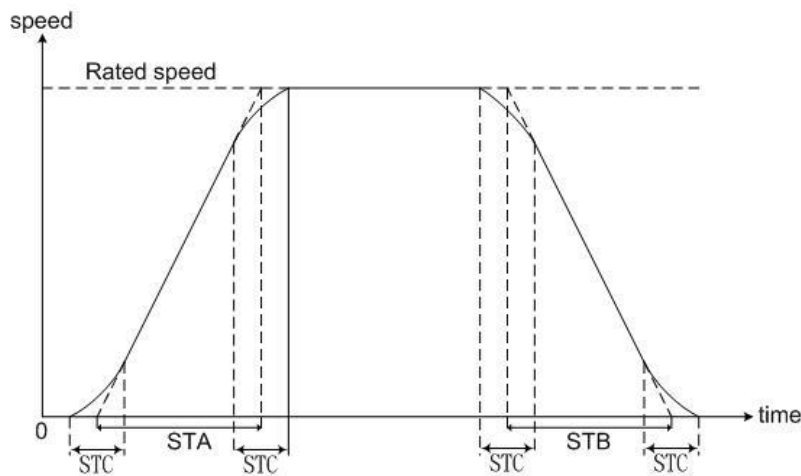

- ◆ Protection during acceleration/deceleration is occupied in the speed control mode.
- ◆ STA, STB, STC could be set independently. Even if STC is “0”, a trapezoidal-pattern is provided.

### Low-pass filter smooth time constant

Name	Name Abbr.	Sign	Setting range	Unit	Default	Control mode
Speed low-pass filter smooth time constant [ms]	SFLT	PB18	0~1000	ms	0	S,T

A larger parameter value would soothe the speed command more obviously. However, the response would slow down as well. If it is set as zero, this function is disabled.

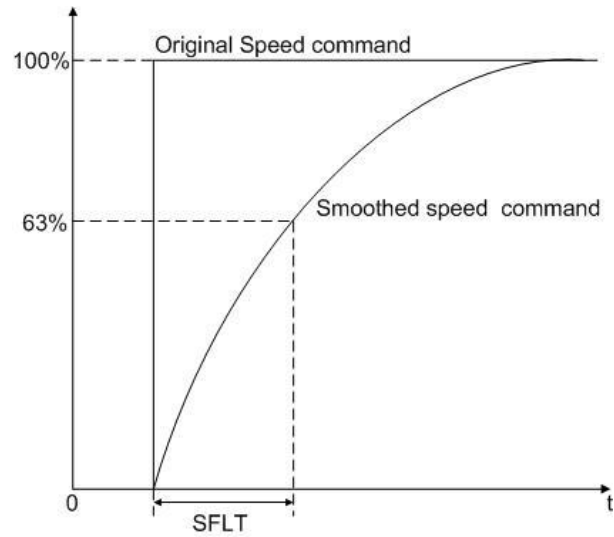

#### 6.6.4. Torque limit of speed control mode

There are 2 parameters: PA05 and PC25 which are related to the torque limit function.

Name	Name Abbr.	Sign	Setting range	Unit	Default	Control mode
Inner torque limit 1 [%]	TL1	PA05	0~100	%	100	ALL
Inner torque limit 2 [%]	TL2	PC25	0~100	%	100	ALL

Here are 3 pin functions of CN1: 1 analog voltage input and 2 DI inputs which are described below:

Name	Abbr.	Description	Control mode
Torque analog limit	TLA	This signal is valid by the setting of PD02~PD09 to make TL enable. As TLA is valid, the torque output would be limited. When TLA is connected to the positive polarity of the power source, a maximum torque will be generated at +10V.	Pt, Pr, S
Torque limit option	TL	Set the PD02~PD09 parameter to enable this signal. As TL-SG is open circuit, the inner torque limit 1(PA05) is valid. In case of short circuit, the torque analog limitation (TLA) effective.	Pt, Pr, S
Inner torque limit option	TL1	Set the PD02~PD09 parameter to enable this signal. As TL1-SG is short circuit, the Inner torque limit 2(PC25) effective.	ALL

There are 4 combinations which are decided by the signal state of TL and TL1.

DI signal status(*)		The valid value of torque limit
TL1	TL	
0	0	The setting value of PA05
0	1	If TLA is less than PA05, then TLA is valid. If TLA is greater than PA05 then PA05 is valid.
1	0	If PC25 is less than PA05, then PC25 is valid. If PC25 is greater than PA05, then PA05 is valid.
1	1	If PC25 is less than TLA, then PC25 is valid. If PC25 is greater than TLA, then TLA is valid.

(\*) 0: OFF(TL1-SG or TL-SG is open-circuit) , 1 : ON(TL1-SG or TL-SG is short-circuit)

If the generated torque suits the value of PA05 or PC25 or torque analog limit, the TLC of DO signal becomes conductive with SG.

Pin/Signal name	Name Abbr.	Description	Control mode
Torque limiting control	TLC	TLC-SG is conductive as the generated torque reaches the inner torque limit 1(PA05), or the torque analog limit (TLA).TLC-SG is isolated when SERVO ON(SON) is off.	Pt,Pr,S

### 6.6.5. Adjustment of speed loop gain

There are some parameters related to inner speed control loop for users to adjust. Set the value of the PA02 to use the auto-gain tuning function or manual-gain tuning function. If auto-gain tuning function is performed, the load inertia ratio would be approximated continuously and the control gain value would be set automatically. If manual-gain gain tuning is performed, users have to enter the proper value of the load inertia ratio and control gain value. At this time, all automatic or auxiliary functions about inner speed control loop would be disabled. The block diagram of inner speed control loop is presented as follows:

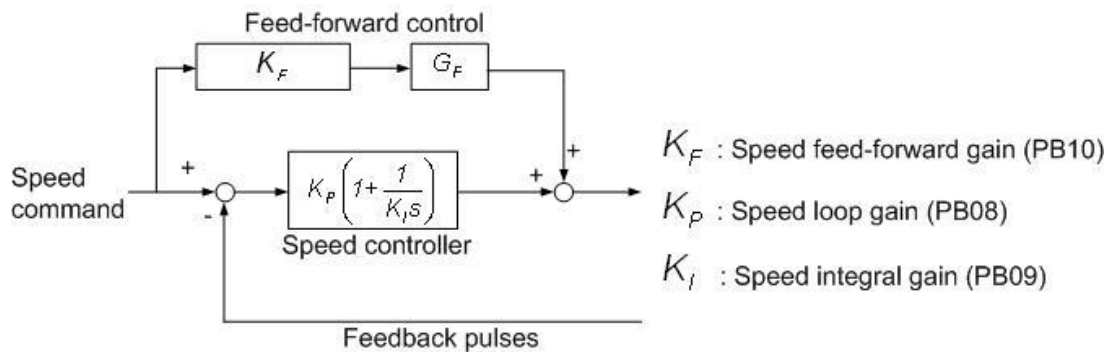

Parameters and settings related of this mode are presented below.

Name	Name Abbr.	Sign	Setting range	Unit	Default	Control mode
Gain tuning mode option	ATUM	PA02	0000h ~0003h	---	0002h	Pt, Pr, S
Auto-tuning response level setting	ATUL	PA03	0001h ~000Fh	---	0005h	Pt, Pr, S
Speed loop gain	VG1	PB08	40 ~4096	rad/s	817	Pt, Pr, S
Speed integral gain	VIC	PB09	1 ~1000	ms	48	Pt, Pr, S
Speed feed-forward gain	VFG	PB10	0 ~20000	0.0001	0	S

#### Auto-gain tuning mode

The drive would tune the optimum gains during the acceleration/deceleration route. Refer to section 5.3.2 for further details.

#### Manual-gain tuning mode

When the PA02 value is 0000h or 0001h, the effective parameters are: speed loop gain(PB08), speed integral gain(PB09) and speed feed-forward gain (PB10). When PA02 is set as 0001, the servo drive would automatically enable an interference compensator. This function could reduce torque ripple, overshoot and speed ripple. It is suitable for systems with load changed violently. Besides, users should avoid applying this compensator on the system which the ratio of load inertia to motor shaft is greater than 10 times. If necessary, the related parameters should be adjusted according to the various cases. The schematic diagram is as follows.

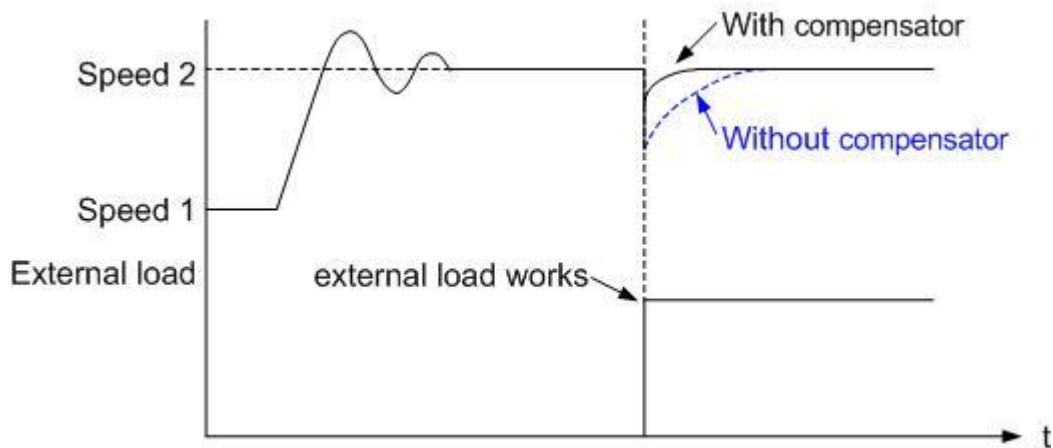

#### Parameters for manual-gain tuning mode

Speed loop gain :

Increasing this parameter would improve the bandwidth of speed control loop, but a too large value would cause the mechanism vibration. Therefore, it is recommended to operate the auto-gain tuning mode to approximate a proper value at first. If the value could not satisfy the requirement, to increase this value gradually until the mechanism vibration occurred.

Speed integral gain :

Decreasing this parameter would improve the low-frequency rigidity of speed control loop and reduce the speed stability errors. On the other hand, a too small value would cause the phase delay to make an instable system.

Speed feed-forward gain :

The speed feed-forward gain could reduce the phase lag errors, and increase the traceability. If the setting value is near 1, the dynamic tracking error would be very small and the pre-compensation will be the most completed. If the setting value is too low, the improvement would not obvious. But a too high value would cause the system vibration easily.

### 6.6.6. Resonance and vibration suppression filter

The SDE servo drive provides “auto resonance suppression function”. The relevant parameters and settings are described in the following table. 3 sets of resonance suppression filter, a low-pass filter to suppress resonance, in accordance with the needs of the user can manually or automatically suppressed suppression will be sequentially described.

Name	Abbr.	Sign	Setting range	Unit	Control mode
Machine resonance suppression filter 1	NHF1	PB01	50 ~1000	Hz	ALL
Machine resonance suppression attenuation 1	NHD1	PB02	0 ~32	dB	ALL
Resonance suppression low-pass filter	NLP	PB03	0 ~10000	0.1mS	ALL
Machine resonance suppression filter 2	NHF2	PB21	50 ~1000	Hz	ALL
Machine resonance suppression attenuation 2	NHD2	PB22	0 ~32	dB	ALL
Machine resonance suppression filter 3	NHF3	PB25	10 ~4000	Hz	ALL
Machine resonance suppression attenuation 3	NHD3	PB26	0 ~32	dB	ALL
Auto resonance suppression mode	ANCF	PB27	0 ~32	-	ALL
Resonance suppression detection level	ANCL	PB28	0 ~10000	%	ALL

#### (1) Resonance suppression

##### (a) Manual mode

The SDE servo drive provides 3 resonance suppression filters and 1 resonance suppression low-pass filter. If the resonance frequency of mechanism is known, users can set the filter frequency and attenuation degree manually. Increase these parameters gradually and observe the effect until the resonance erased. To eliminate the resonance means the reduction of mechanism system bandwidth.

##### (b) Auto mode

The SDE servo drive provides 2 resonance suppression filters for auto mode. When the resonance is occurred, user can set PB27 to enable the auto mode. (PB27=1 or PB27=2) In auto mode, the drive will detect the resonance frequency then will decide the attenuation degree. The result of auto mode will be stored into PB01/PB02 and PB21/PB22. If PB27 is set as 1 when auto mode is performed, after the resonance detection, the PB27 will automatically recover to 0. If PB27 is set as 2, the resonance detection and suppression will always keep going.

After trying auto mode once, if the resonance phenomenon still exists, check the PB02 and PB22. If one of them is 32, it means the resonance could not be compensated in current response level. It is recommended to reduce response level then try auto mode again. If one of



PB02 and PB32 is a non-zero value but less than 32, it means the attenuation degree is not sufficient to compensate the resonance magnitude. Thus, users can try a higher value of PB02 and PB22. If PB02 and PB22 are zero, it means the resonance frequency is not detected due to a too high setting value of PB28. Try to reduce the PB28 value then run auto mode again. The resonance suppression flowchart of auto mode is described below.

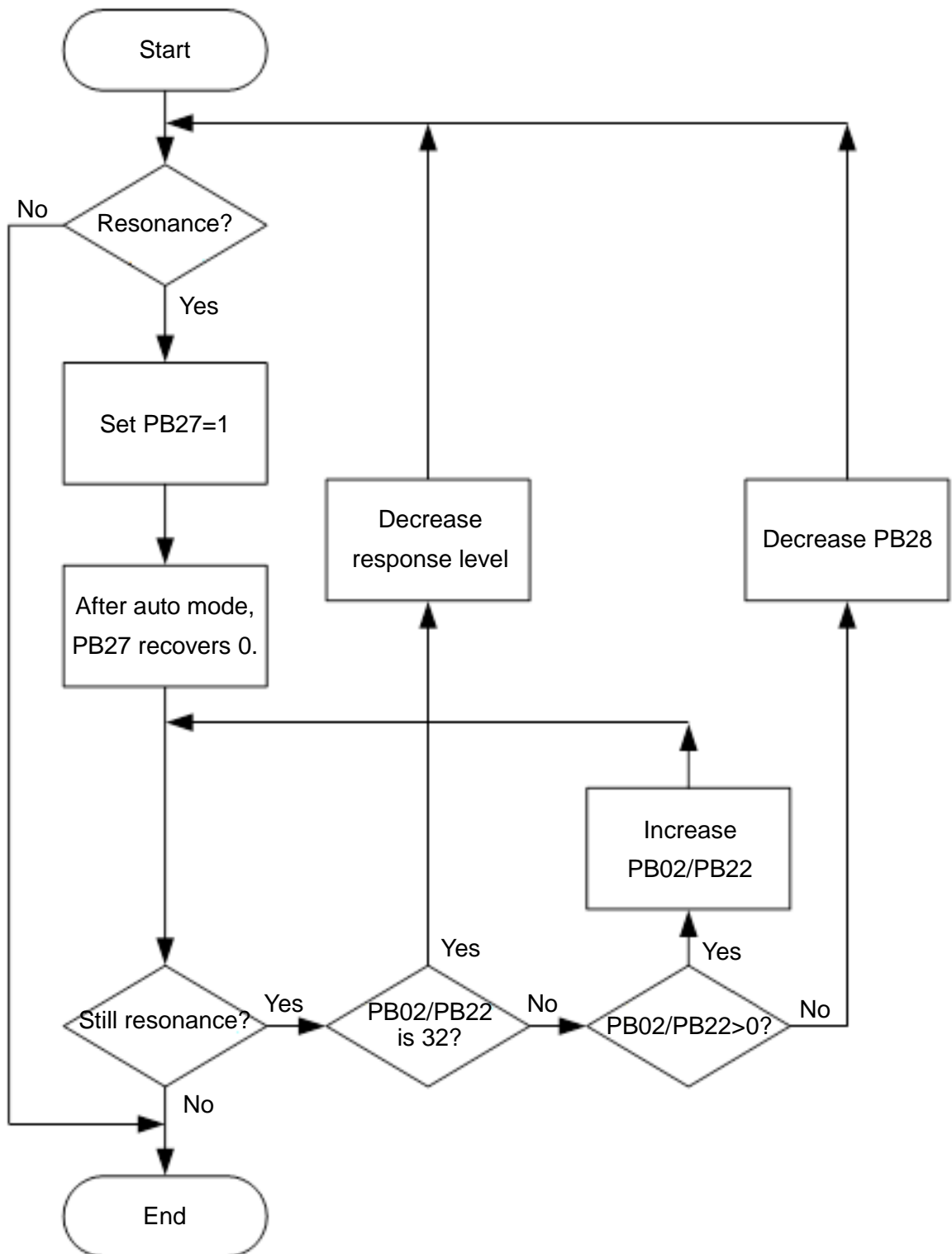

## (2) Vibration suppression

Vibration often occurs in a mechanism which the rigidity is poor. In such system, the settling time of position control becomes longer. For some application, a shorter settling time is necessary; vibration suppression function can satisfy this demand. The relevant parameters are described below.

Name	Abbr.	Sign	Setting range	Unit	Control mode
Auto vibration suppression mode	AVSM	PB29	0 ~1	-	Pt, Pr
Low-frequency vibration detection level	VCL	PB30	1 ~800	Pulse	Pt, Pr
Vibration suppression frequency 1	VSF1	PB31	1 ~3000	0.1Hz	Pt, Pr
Vibration suppression gain 1	VSG1	PB32	0 ~15	-	Pt, Pr
Vibration suppression frequency 2	VSF2	PB33	1 ~3000	0.1Hz	Pt, Pr
Vibration suppression gain 2	VSG2	PB34	0 ~15	-	Pt, Pr

### (a) Manual mode

When vibration suppression manual mode is performed, the relevant parameters PB31/PB32 and PB33/PB34 are used to suppress the vibration. For the known vibration situation, users can set the vibration frequency into PB31、PB33, then set PB32、PB34 as 1 to enable the suppression function. The 0 value of PB32 and PB34 mean the vibration suppression disabled.

### (b) Auto mode

When vibration suppression auto mode is performed, please set PB29=1 to enable the auto mode. Even though the vibration frequency of mechanical system is unknown, auto mode will find the system vibration frequency, and then record the results into PB31 and PB33, and set PB32 and PB34 as 1. After the completion of auto mode, PB29 recovers 0.

After execution of auto mode, if the vibration phenomenon still exists, check PB32 and PB34 value whether they are 0. The zero value means that auto mode did not find the vibration frequency due to a higher value setting of PB30. Users can decrease PB30 then run auto mode again to find the vibration frequency. The non-zero value means auto detection fails, the result frequency is not the exact vibration frequency, users can increase PB30 then run auto mode again to find the vibration frequency.

The vibration suppression flowchart of auto mode is described below.

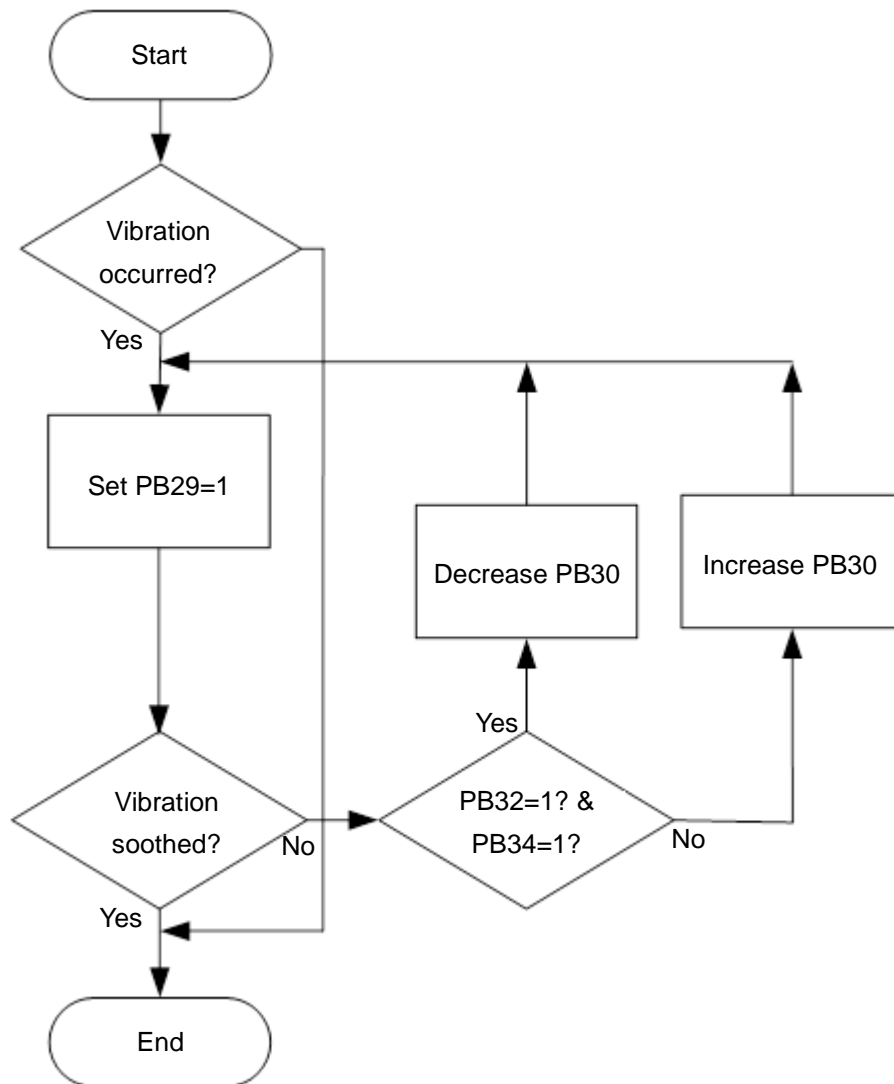

### 6.6.7. Gain switch function

SDE servo drive provides gain switch function when servo motor is running or stop. It can be performed via the DI pins which are set to make gain switch function valid. If users want to apply gain switch function, manual gain tuning mode must be chosen. (PA02 is set as 0000 or 0001) If the auto-gain tuning mode is chosen, the gain switch function cannot be performed. Some applicable occasions are described as below.

- (1) A higher gain values may cause the electromagnetic noises of servo motor. Operate gain switch function to reduce this phenomenon.
- (2) A variable inertia load is driven in the requested stroke. Perform gain switch function to soothe the vibration or resonance.
- (3) To improve the response or to shorten the settling time of the machinery system. Use gain switch function to satisfy this need.

The relevant parameters and the detail descriptions are listed below.

Name	Abbr.	Sign	Setting range	Unit	Default	Control mode
Load to motor inertia ratio	GD1	PB06	0 ~1200	0.1time	70	Pt, Pr, S
Position loop gain	PG1	PB07	4 ~1024	rad/s	45	Pt, Pr
Speed loop gain	VG1	PB08	40 ~9000	rad/s	183	Pt, Pr, S
Speed integral gain	VIC	PB09	1 ~1000	ms	34	Pt, Pr, S
Gain switch option	CDP	PB11	0000h ~0008h	-	0000h	Pt, Pr, S
Gain switch condition value	CDS	PB12	0 ~4000000	(*)	10	Pt, Pr, S
Gain switch time constant	CDT	PB13	0 ~1000	ms	1	Pt, Pr, S
Load to motor inertia ratio 2	GD2	PB14	0 ~1200	0.1time	70	Pt, Pr, S
Position loop gain change ratio	PG2	PB15	10 ~500	%	100	Pt, Pr
Speed loop gain change ratio	VG2	PB16	10 ~500	%	100	Pt, Pr, S
Speed integral gain change ratio	VIC2	PB17	10 ~500	%	100	Pt, Pr, S

Parameters related to gain switching are described below.

(1) The tuning for GD1, PG1, VG1, VIC (PB06~PB09) is the same as manual-gain tuning mode, but they are changeable in this gain switch operation.

(2) Gain switch option CDP (PB11)

It is to set the gain changing condition. Enable the trigger condition in the lowest digit. If users set "1" here, they could use the CDP signal of DI for gain changing. The CDP signal could be assigned to any DI pins by setting PD02~ PD09, PD21~PD24.

0	0	0	x
---	---	---	---

x=0: Invalid

x=1: CDP signal is ON

x=2: Position command frequency is equal to or higher than CDS (PB12) setting

x=3: Position command pulse error is equal to higher than CDS (PB12) setting

x=4: Motor speed is equal to or higher than CDS (PB12) setting

x=5: CDP signal is OFF

x=6: Position command frequency is less than CDS (PB12) setting

x=7: Position command pulse error is less than CDS (PB12) setting

x=8: Motor speed is less than parameter CDS (PB12) setting

(3) Gain switch condition value CDS (PB12)

As users selected "position command frequency", "position command pulse error" or motor speed" in gain switch option (PB11), set the corresponding gain switch condition.

(\*)The setting unit is as follows.

PB11 setting	Gain switch condition	Unit
□□□2	Position command frequency $\geq$ PB12	kpps
□□□3	Position command pulse error $\geq$ PB12	pulse
□□□4	Motor speed $\geq$ PB12	rpm
□□□6	Position command frequency $<$ PB12	kpps
□□□7	Position command pulse error $<$ PB12	pulse
□□□8	Motor speed $<$ PB12	rpm

(4) Gain switch time constant, CDT (PB13)

It is used to smooth the motor running at gain switching moment to suppress vibration due to a large gain difference.

(5) Load to motor inertia ratio 2, GD2 (PB14)

Set the demand ratio value to meet the actual load changed after switching. If the load inertia ratio does not change, set it to the same value as GD1 (PB06).

(6) PG1, VG1, VIC

The original gain values would be switched to the ratio values of PG2/VG2/VIC2 settings.

Example 1: CDP signal is the switch trigger.

①. Relevant parameters setting: GD2=20, PG2=80%, VG2=120%, VIC2=150%

Function	Initial	Switch	Before	After
Load to motor inertia ratio	GD1	GD2	10	20
Position loop gain	PG1	PG1*PG2	100	80
Speed loop gain	VG1	VG1*VG2	500	600
Speed integral gain	VIC	VIC*VIC2	100	150
Gain switch option	CDP	PB11	0001h	0001h

②. The sequence of gain switch

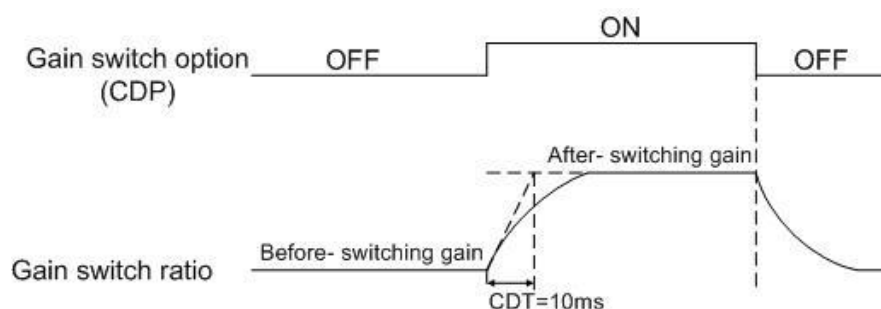

③. The states of parameters change

Name	CDP OFF		CDP ON		CDP OFF
Load to motor inertia ratio	10	→	20	→	10
Position loop gain	100	→	80	→	100
Speed loop gain	500	→	600	→	500
Speed integral gain	100	→	150	→	100

Example 2: Trigger condition of position command pulse error.

①. Relevant parameters setting: GD2=20, PG2=80%, VG2=120%, VIC2=150%

Function	Initial	Switch	Before	After
Load to motor inertia ratio	GD1	GD2	10	20
Position loop gain	PG1	PG1*PG2	100	80
Speed loop gain	VG1	VG1*VG2	500	600
Speed integral gain	VIC	VIC*VIC2	100	150
Gain switch option	CDP	PB11	0003h	0003h
Gain switch condition value	CDS	CDS	100	100

②. The sequence of gain switch

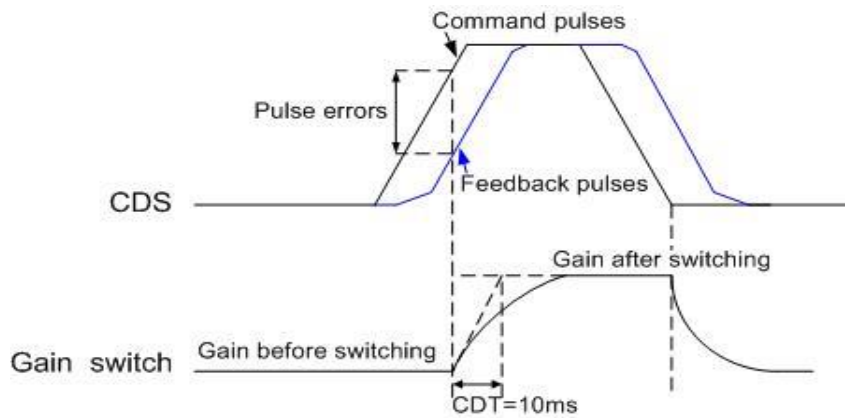

③. The states of parameters change

Name	CDP OFF		CDP ON		CDP OFF
The ratio of load inertia to motor shaft	10	→	20	→	10
Position loop gain	100	→	80	→	100
Speed loop gain	500	→	600	→	500
Speed integral gain	100	→	150	→	100

## 6.7. Position control mode

X-Y table, CNC processing, where require highly accurate positioning are suitable for position control. There are two sources for position command: one is the external pulses and the other is internal registers. The external pulses are from the superior controllers. The inner registers enable users to program 63 positions via DI function of POS1 to PO6. The following table explains the relevant settings of position command source.

Name	Name abbr.	Sign	Control mode	Description				
Control mode option	STY	PA01 (*)	ALL	Setting value: <table border="1" style="display: inline-table; vertical-align: middle;"> <tr> <td>u</td> <td>z</td> <td>y</td> <td>x</td> </tr> </table> <u>x</u> : control mode select 0: position <u>y</u> : position command select 0: external input 1: inner register	u	z	y	x
u	z	y	x					

(\*)The modification of PA01 would be valid by power off once and power on again.

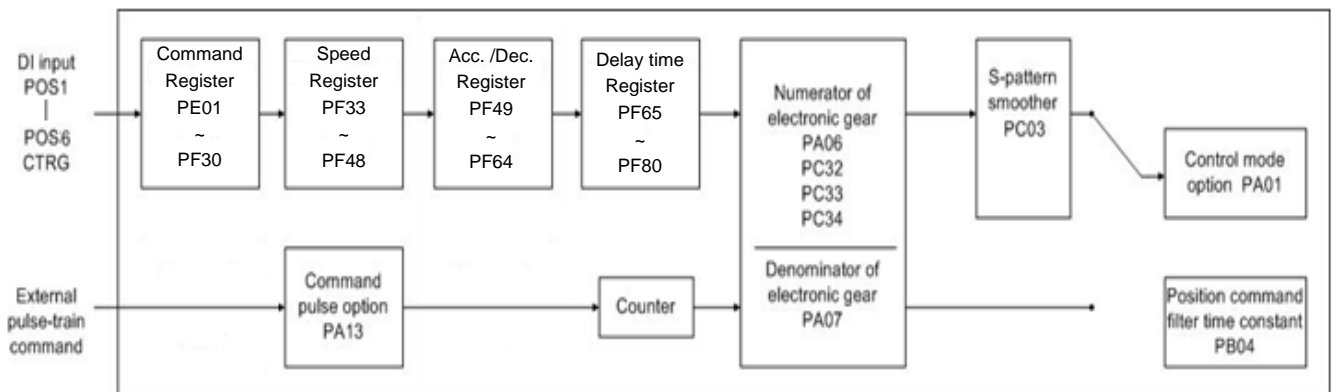

Note: The S-pattern smooth is invalid when the external pulse-train commands are applied.

### 6.7.1. External pulse-train command (Pt mode)

























The position pulses commands are from external devices. Set PA01=0x0000 to enable this mode. There are 3 formats which could be used by users. The pulse trigger could be assigned into positive or negative logic. Positive logic means that the drive recognizes the pulse valid by the rising edge. On the other hand, negative logic means the falling edge. Related parameter is listed below.

Name	Abbr.	Sign	Control mode	Description				
Command pulse option	PLSS	PA13	Pt	Setting values: <table border="1" style="display: inline-table; vertical-align: middle;"> <tr> <td>0</td> <td>z</td> <td>y</td> <td>x</td> </tr> </table> <u>x</u> : pulse-train format select 0: forward/reverse rotation pulse train 1: pulse train + sign 2: A/B phase pulse train <u>y</u> : acknowledged logic 0: positive logic 1: negative logic	0	z	y	x
0	z	y	x					

Command pulse option	PLSS	PA13	Pt	<u>z: filter option</u> 0: Max. frequency permission is 500kpps ( 200kpps< pulse frequency<=500kpps) 1: Max. frequency permission is 200kpps ( 0< pulse frequency<=200kpps) 2: Max. frequency permission is 2Mpps ( 500kpps< pulse frequency<=2Mpps) 3: Max. pulse frequency is 4Mpps ( 2Mpps< pulse frequency<=4Mpps)
----------------------	------	------	----	--

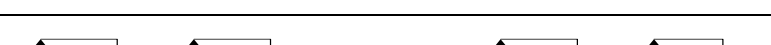
The PA13 would not be changed when SON is ON and be valid by power off once and power on again.

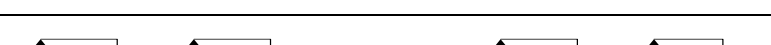
The following table is the description of the pulse format and acknowledged logic.

Pulse-train form		Forward	Reverse
Positive logic	Forward/reverse rotation pulse train	PP  NP 	PP  NP 
	Pulse train + sign	PP  NP 	PP  NP 
	A/B phase pulse	PP  NP 	PP  NP 
Negative logic	Forward/reverse rotation pulse train	PP  NP 	PP  NP 
	pulse train + sign	PP  NP 	PP  NP 
	A/B phase pulse train	PP  NP 	PP  NP 

If pulse train is line drive type, the highest permissible frequency is 4Mpps. If pulse train is open collector type, the highest permissible frequency is 200Kpps.



### 6.7.2. Inner register command (Pr mode)

The following table explains the combinations of POS~POS6, CTRG.

Command	POS6	POS5	POS4	POS3	POS2	POS1	CTRG	Relevant parameters
P0	0	0	0	0	0	0	↑	PE01
								PE02
P1	0	0	0	0	0	1	↑	PE03
								PE04
P2	0	0	0	0	1	0	↑	PE05
								PE06
~								
P50	1	1	0	0	0	1	↑	PF03
								PF04
P51	1	0	0	0	1	0	↑	PF05
								PF06
~								
P63	1	1	1	1	1	1	↑	PF29
								PF30

Note1: The state “↑” of CTRG means the transient of open-circuit to short-circuit.

Note2: 0: OFF (POSx-SG is open-circuit), 1: ON (POSx-SG is short-circuit), x=1~3

Operate the ON/OFF state of POS1 to POS6 cyclically; user can program a simple motion stroke.

#### Absolute / incremental position control

The applications of absolute/incremental command are common. Users have to make PA01 valid to enable these two types. See the table below for parameter setup.

Name	Abbr.	Sign	Control mode	Description				
Control mode option	STY	PA01	ALL	Setting value of Control mode option: <table border="1" style="display: inline-table; vertical-align: middle;"> <tr> <td>u</td> <td>z</td> <td>y</td> <td>x</td> </tr> </table> x=0: position control mode y=1: inner register(absolute type) y=2: inner register(incremental type)	u	z	y	x
u	z	y	x					

The results between absolute and incremental type are described below.

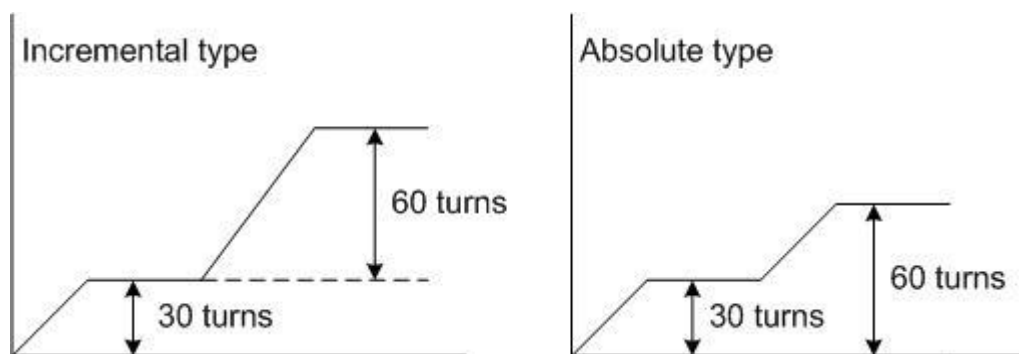

### 6.7.3. Position command smoothing

This is used to smooth motor running when an extreme position command is applied.

Name	Sign	Setting range	Unit	Default	Control mode
Position command filter time constant	PB04	0~20000	ms	3	Pt, Pr

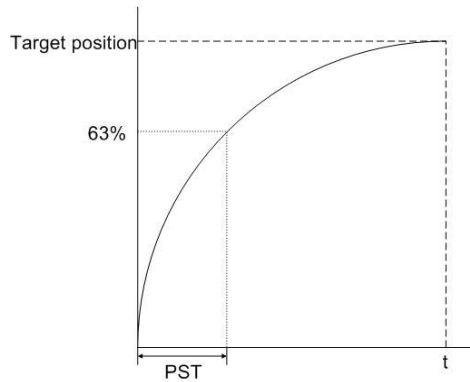

To use the S-pattern smoothing could improve the acceleration/deceleration vibration. The load inertia ratio increased or occasion with huge inertia change may cause a motor rough running. In this case, users could use the STA (PC01), STB (PC02) and STC (PC03) to improve the phenomenon.

When the external pulse-train position command is applied, the STA (PC01), STB (PC02), STC (PC03) would be invalid.

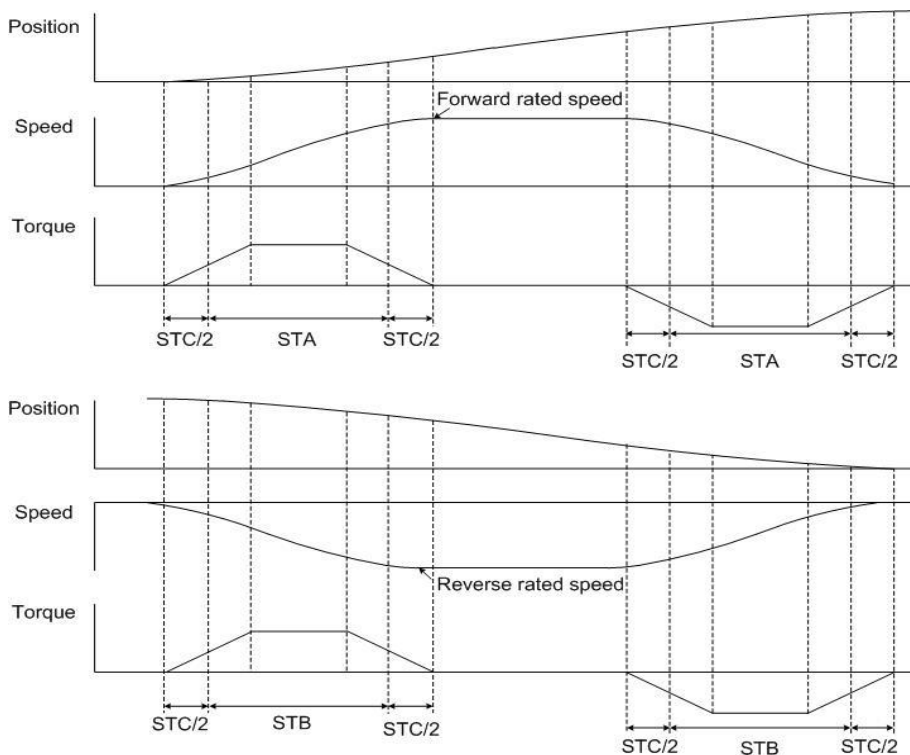

As a forward rotation due to position command is done, the acceleration/deceleration time is decided by the PC01. On the other hand, the acceleration/deceleration time of a reverse rotation due to other position command is controlled by the PC02.

As the inner register command is applied, it is recommended to use the S-pattern smoothing.

### 6.7.4. Electronic gear

Users could set different electronic gear ratios to enable the mechanism to move different distances. Relevant parameters are presented below.

Name	Name Abbr.	Sign	Setting range	Unit	Default	Control mode
Electronic gear numerator	CMX	PA06	$\sim 2^{26}$ <sup>1</sup>	-	1	Pt,Pr
Electronic gear denominator	CDV	PA07	$\sim 2^{26}$ <sup>1</sup>			
Electronic gear numerator 2	CMX2	PC32	$\sim 2^{26}$ <sup>1</sup>			
Electronic gear numerator 3	CMX3	PC33	$\sim 2^{26}$ <sup>1</sup>			
Electronic gear numerator 4	CMX4	PC34	$\sim 2^{26}$ <sup>1</sup>			

The improper setting could lead to unexpected fast rotation so make sure to set them in the state

of SERVO OFF. The range of the electronic gear ratio is  $\frac{1}{50} \leq \frac{CMX}{CDV}$  (electronic gear ratio)  $\leq 64000$ . If the setting

value is outside this range, the operation of motor may not be performed. The relationship of electronic gear numerator and electronic gear denominator is plotted below.

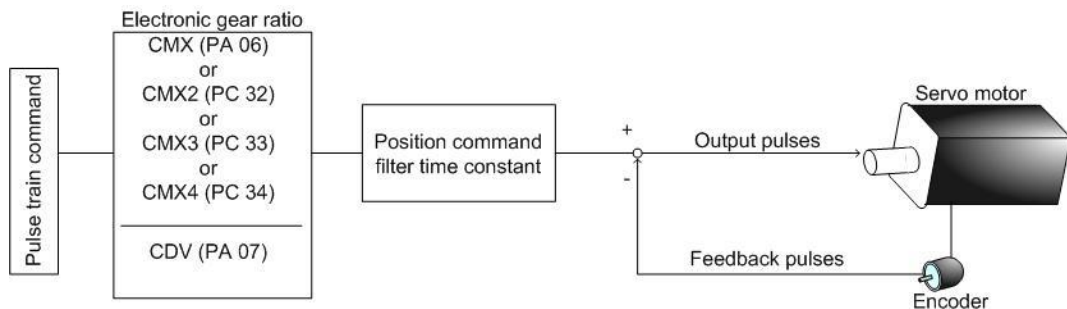

4 electronic gear numerators are available for users to select. Enable the function CM1 and CM2 of DI to switch. See the table below.

Name	CM1	CM2	Control mode
Electronic gear numerator (PA06)	0	0	Pt, Pr
Electronic gear numerator 2 (PC32)	1	0	
Electronic gear numerator 3 (PC33)	0	1	
Electronic gear numerator 4 (PC34)	1	1	

Note: 0: OFF (CMx-SG is open-circuit), 1: ON (CMx-SG is short-circuit), x=1,2

#### Calculation of electronic gear ratio

Before calculating this value, users have to know the specifications the motor encoder resolution ( $2^{22}=4194304$ ppr), the reduction rate, gear ratio of machine. Use the following equation to calculate the electronic gear ratio.

$$\text{Electronic gear ratio} = \frac{\text{Encoder resolution}}{\text{Load distance per revolutio(angle)} / \text{Distance pulses to be shifted entered by user}}$$

If a reduction between motor and loads exists, to multiply the factor:  $\frac{a \text{ turn of motor shaft}}{\text{mechanism turns}}$ .

The following example explains the method for setting the electronic gear ratio.

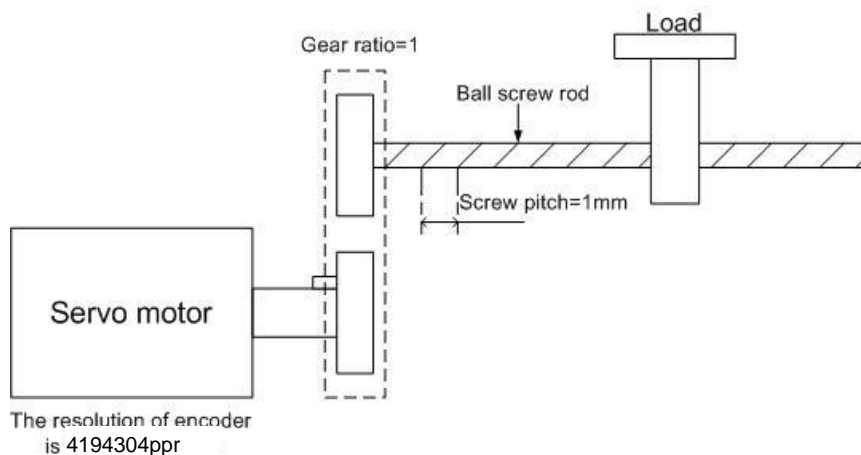

Load distance per revolution is 1mm, the resolution of motor encoder is 2500ppr, the gear ratio of load mechanism to motor shaft is 1, if the demand distance is 5 $\mu$ m, the calculation is listed below.

$$\text{Electronic gear ratio} = \frac{2500 \times 4}{1\text{mm} / 5\mu\text{m}} \times \frac{1}{1} = \frac{4194304}{200}$$

From above, it could be known that by setting the electronic gear numerator as 4194304 and set the electronic gear denominator as 200, and then the ball screw rod would be shift a 5- $\mu$ m distance after a position pulse command.

### 6.7.5. Torque limit of position control mode

See section 6.6.4 for details.

### 6.7.6. Position loop gain

If users need to use manual-gain tuning for position loop, to set parameters of speed loop (see Section 6.6.5) is priority since position loop is outside control of speed loop. Then users could set proportion gain and feed-forward gain of position loop. Usually, position gain is 1/4~1/6 value of the speed loop gain. Users could also use auto-gain tuning mode to set the gains of position and speed loop automatically. Position loop block diagram is presented below.

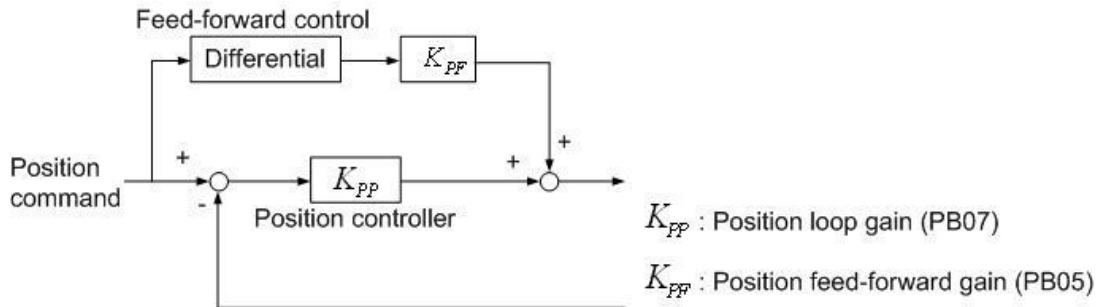

Parameters related to position gain adjustment are listed below.

Name	Name Abbr.	Sign	Setting range	Unit	Default	Control mode
Gain tuning mode option	ATUM	PA02	0000h ~0004h	-	0002h	ALL
Auto-tuning response level setting	ATUL	PA03	1 ~32	-	10	
Position feed-forward gain	FFC	PB05	0 ~200	%	0	Pt, Pr
Position loop gain	PG1	PB07	4 ~1024	rad/s	45	

If PG1 (PB07) is set too large, the motor would generate vibration even though the bandwidth and response are becoming faster. These phenomena are not permitted for occasions requiring an accurate position control. In this case, be sure to reduce PG1 value to prevent motor vibration. If the bandwidth limited due to mechanism factors causes a bad traceability, position feed-forward gain could be used to reduce the dynamic error of position tracking. On the other hand, the usage of feed-forward control also relatively increases the position settling time.

The method for adjusting position feed-forward gain is to increase the value gradually. Theoretically, 1 is the best setting value. The improper value would cause machine vibration easily. In such case, users should decrease the position feed-forward gain to meet a vibration-free situation.

## 6.8. Control mode switch

SDE servo drives provide 5 modes switch to fit users who need to change varied modes frequently. The PA01 could be changed for the control mode switch. See the table below.

Control mode		Abbr.	PA01 setting	Description
Hybrid mode	Position with external command - speed	Pt-S	1001h	Use DI signal to switch Pt and S
	Position with external command - torque	Pt-T	1005h	Use DI signal to switch Pt and T
	Position with inner register command - speed	Pr-S	1011h	Use DI signal to switch Pr and S
	Position with inner register command - torque	Pr-T	1015h	Use DI signal to switch Pr and T
	Speed - torque	S-T	1003h	Use DI signal to switch S and T

The arrangement of DI and DO is critical when the control mode switch is applied. To avoid DI/DO pins insufficient, users could apply external analog voltage signal as speed or torque command so that could reduce the demand of DI.

The LOP function should be made valid once control mode switch is applied. See the following table.

Name	Sign	I/O	CN1 No.	Description	Control mode	
Control mode switch	LOP	DI	CN1-21 (default)	Option of position/speed switched		Described by varied case
				LOP(*)	Control mode	
				0	position	
				1	speed	
				Option of speed/torque switched		
				LOP(*)	Control mode	
				0	speed	
				1	torque	
				Option of torque/position switched		
				LOP(*)	Control mode	
				0	torque	
				1	position	

(\*) 0: OFF (LOP-SG is open-circuit), 1:ON (LOP-SG is short-circuit)

Note: The pin function setting of ST1 and RS2 are the same value, as speed/torque mode switch is applied and the LOP signal activated, the ST1 function would have priority in speed control mode and the RS2 function would have priority in torque control mode. Others such as POS1/SP2, PC/ST1, RS2/PC, TL/ST2, ST2/RS1, RS1/TL, CR/SP1 are defined mutually. The drive would automatically recognize the corresponding DI pin function when 2 different modes are switched. See Section 3.3.4 for more details.

### 6.8.1. Position/speed mode switch

This mode switch is divided into 2 types: Pt/S and Pr/S. The sequence chart of mode switch is presented in the figure below.

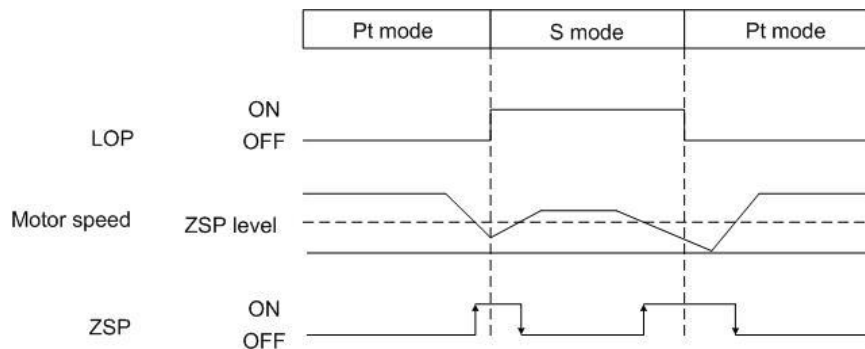

Control mode could not be switched if the motor is at a high speed rotation. It could be performed once the zero speed detection output signal is ON. Yet it is recommended for users to switch control mode when the motor is stopped completely.

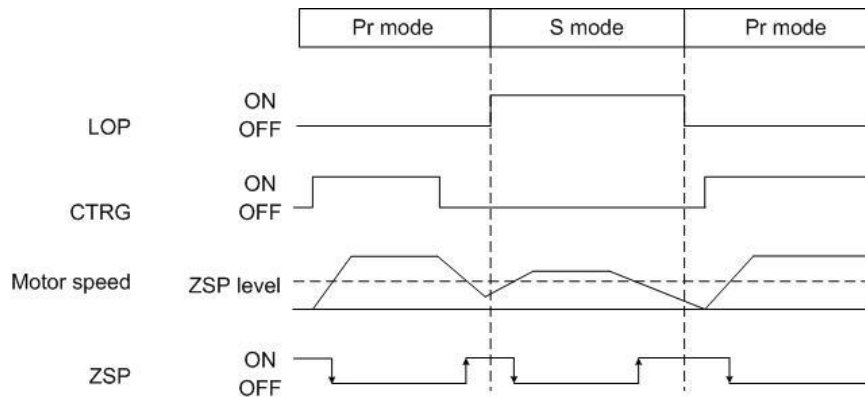

### 6.8.2. Speed/torque hybrid mode

Set the PA01 as 1003h before this control mode switch is performed. Users could use the LOP signal to switch speed mode and torque mode. Because pin function ST1 (ST2) and RS2 (RS1) are defined mutually, the rotation direction of motor would reverse while changing between the speed and torque modes. The sequence diagram of the speed / torque mode is presented below.

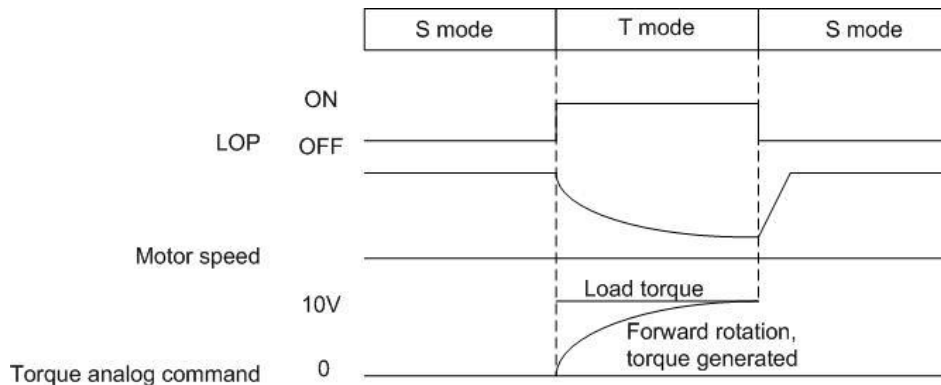

It is recommended that users switch the speed to torque mode after the motor is static.

### 6.8.3. Torque/Position control mode switch

This hybrid mode is divided into 2 types: T/Pt and T/Pr. Users could set the PA01 as 1005h (T/Pt mode) or 1015h (T/Pr mode). The switch could not be performed if the motor is at a high speed rotation. It could be switched as the zero speed detection output signal is ON. Users could use the pin function LOP of DI to switch these 2 modes. When the position mode with inner register command is wanted, the state of CTRG signal must be turned on. The sequence chart is presented in the figure below.

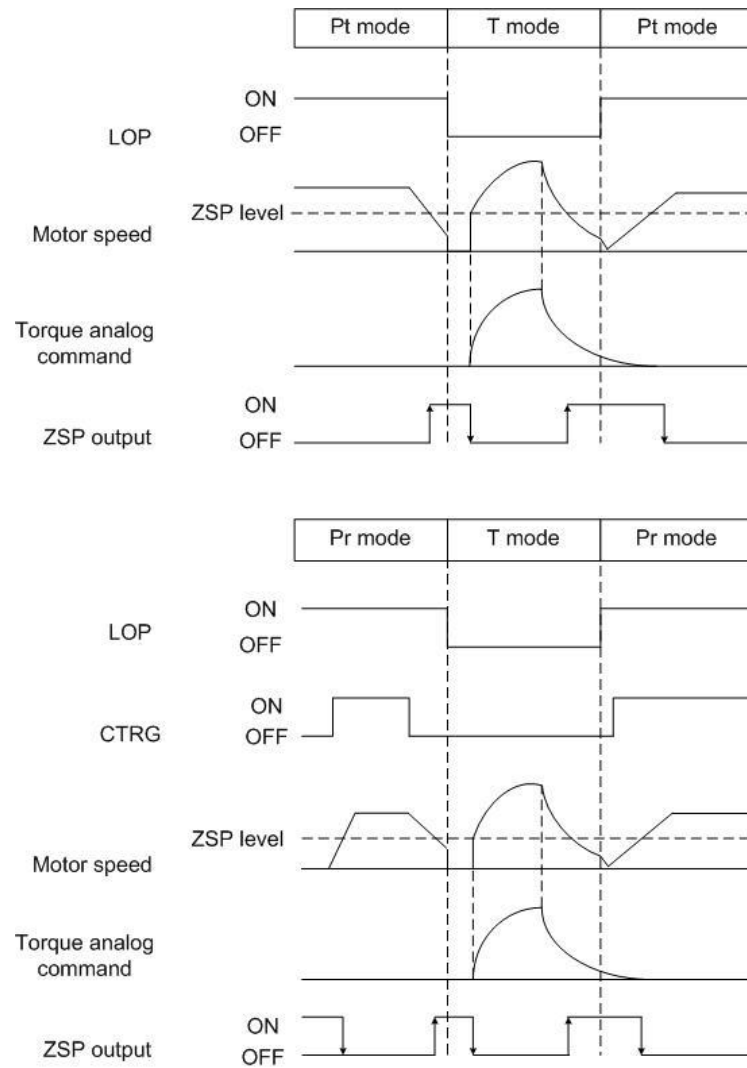

It is recommended that users switch torque to position mode after the motor is static.



## 6.9. Other functions

**⚠ DANGER** Before wiring, turn off the power and wait for 10 minutes or more until the charge LED turns off. Otherwise, an electric shock may occur.

**⚠ CAUTION** ●Use the specified auxiliary equipment and options to prevent a malfunction or a fire.

### 6.9.1. Selection of brake resistor

**⚠ CAUTION** ●Use the specified auxiliary equipment and options to prevent a malfunction or a fire.

As the direction of motor generated torque is opposite to the rotary direction of motor, it becomes a power generator. The regenerative energy would be turned back to the servo drive. To prevent from P-N voltage exceeded, a voltage stabilized protection is necessary. The IGBT switch and brake resistors constitute this protection. Regenerative energy is consumed by the brake resistor.

There is a built-in brake resistor inside the drive (below 3.5KW). If the regenerative energy is too large, it is not recommended to use. Instead, use an external one to avoid overheating. When using the built-in brake resistor, make sure that the P/D terminals is short-circuit. If the external brake resistor applied, make P/D terminals open while the external resistor is connected to the P/C terminals. Built-in brake resistor specifications for the Shihlin servo drive are described below.

Drive(W)	Built-in brake resistor specification		Minimum permissible (Ω)	Consumption power of built-in resistor (W)
	resistor (Ω)	Capacity (W)		
100	100	20	100	10
200	100	20	100	10
400	100	20	100	10
500	100	20	100	10
750	40	40	40	20
1000	40	40	40	20
1500	13	100	13	50
2000	13	100	13	50
3500	13	100	13	50

Note: The average regenerative power that could be consumed is at 50% rated power of the built-in brake resistor. So are the external brake resistors.

As external brake resistor is applied, the same resistance value mentioned above is required. If serial or parallel wiring are applied to increase resistor's power, be sure that the resistance meets the minimum permissible specification. The brake resistor with a thermal switch or a cooling fan would be helpful to tell users that the capacity of brake resistor is insufficient or to reduce the temperature of brake resistor. Please contact the manufacturer of brake resistor to know the detail load characteristic.

To let users easily calculate the power of external brake resistor, the calculations are described below.

(a) Without external load

If the motor is repeated running forward and reverse, the braking regenerative energy would return to the aluminum capacitors of servo drive. When the P-N voltage exceeds a particular value, the brake IGBT switch is turn on and the brake resistor would dissipate the regenerative energy. The following statement and table provide the calculation of regenerative power.

The Es and Ec of various drive capacity are listed below.

Drive (W)	Rotor inertia, J (x10 <sup>-4</sup> kg·m <sup>2</sup> )	Motor type	(*1)Regenerative Energy <b>Es</b> (joule)	(*2)Regenerative Energy <b>Ec</b> (joule)	Max. motor speed (rpm)
Low inertia	100	SME-M10020○□□□	0.28	16.18	3000
	200	SME-M15020○□□□	0.68	16.18	3000
	400	SME-M20020○□□□	1.33	19.78	3000
	750	SME-M30020○□□□	6.07	33.56	3000
	1K	SME-M10020○□□□	13.31	33.56	2000
	1.5K	SME-M15020○□□□	19.30	81.50	2000
	2K	SME-M20020○□□□	25.22	81.50	2000
	3K	SME-M30020○□□□	37.29	81.50	2000
Medium inertia	1K	SME-M10020○□□□	23.25	33.56	2000
	1.5K	SME-M15020○□□□	34.21	81.50	2000
	2K	SME-M20020○□□□	71.06	81.50	2000
	3K	SME-M30020○□□□	136.42	81.50	2000

Note1: Es is the regenerated energy of a motor without loading that runs a rated speed then stops.

Note2: Ec is the motor deceleration energy that charges into the DC capacitors.

The capacity of brake resistor is calculated as follows:

$$P_{BR} = 2 \times ((N+1) \times E_S - E_C) / T$$

Where:

$P_{BR}$  : Power of brake resistor

$N$  : The ratio of load inertia to motor shaft

$T$  : Duty cycle (Defined by users)

If the ratio of load inertia to motor shaft is N, deceleration from the rated speed to stop; the regenerative energy is (N + 1) × Es. The brake resistor consumption is (N + 1) × Es - Ec joules. Assuming the duty cycle is T second, then the recommend power of brake resistor is 2 × ((N + 1) × Es - Ec) / T. The calculation procedure is as follows. J is the motor inertia. (unit: kg · m<sup>2</sup>)

Step	Item	Calculation or procedure
1	Choose the duty cycle T	With user's application to decide the repeat operation cycle.
2	Set motor speed	Panel operation to read/write this value.
3	Set load to motor inertia ratio N	Panel operation to read/write this value.(PA02=0002h)
4	Compute the $E_s$	Refer to the previous table or calculation $E_s = J \times W r^2 / 182$
5	Compute the $E_c$	Refer to the previous table
6	Compute the $P_{BR}$	$2 \times ((N+1) \times E_s - E_c) / T$

### Example 1

The drive capacity is 400W, duty cycle T is 0.5 second, revolution speed is 3000 rpm, load to motor inertia ratio is 3, then the necessary power of brake resistor =  $2 \times ((7 + 1) \times 1.33 - 19.78) / 0.5 = 36.56W$ . Users need to apply an external resistor which its power should be greater than 37W.

**Note:** Due to 3000rpm is the rate speed of 400W servo drive; we could find the  $E_s$  on the previous table is 1.33.

### Example 2

The drive capacity is 2KW, duty cycle T is 1 second, revolution speed is 1000 rpm, load to motor inertia ratio is 20. Since the revolution speed 1000rpm is less than the rated speed (2000rpm), we need to compute  $E_s$ ,  $E_s = 32.48 \times 10^{-4} \times 1000^2 / 182 = 17.8$ , then the necessary power of brake resistor =  $2 \times ((20 + 1) \times 17.8 - 81.5) / 1 = 584$ . These are more than the capacity (50W) of 2KW servo drive's built-in brake resistor. So, a 1000W brake resistor is recommended.

Generally, if the load inertia ratio is small ( $N \leq 5$ ), the capacity is sufficient. If the brake resistor capacity is too small, the heat accumulated is growing easily and the temperature of brake resistor rises soon. When the temperature is higher than a certain value, the brake resistor will be burn out.

### (b) With external load

When the external load torque is greater than motor torque, it makes the servo motor output torque direction is opposite to the rotary direction of servo motor. In this case, the external energy is delivered to the servo drive through the servo motor. The following figure is an example that the motor runs in CCW rotation at constant speed when a sudden external load torque change.

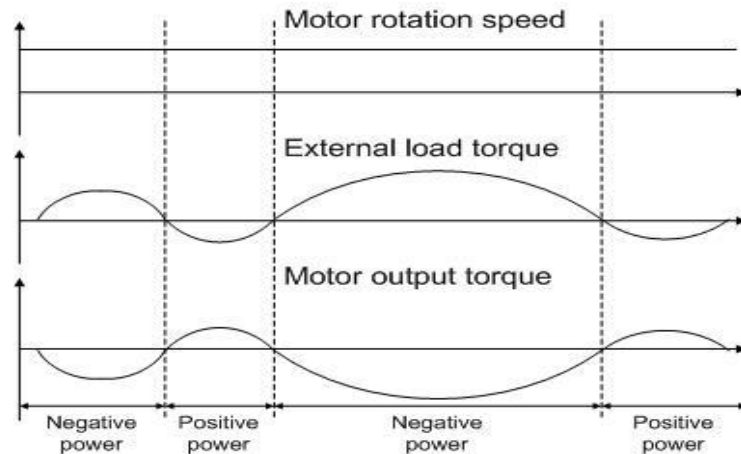

Power of the external load torque:  $P_L = T_L \times \omega$

Where:  $P_L$  is the power of external load torque

$T_L$  is the external load torque. (Unit: Nt-m)

$\omega$  is the motor rotation speed. (Unit: rad/s)

For example:

If an external load torque of +50% rated torque is applied and the servo motor speed is 3000r/min, the servo drive is 400W capacity(rated torque: 1.27Nt-m), then the users need to connect a external brake resistor which power is  $2 \times (0.5 \times 1.27) \times (3000 \times 2 \times \pi / 60) = 399W$ , 100Ω.

Note: 1rpm =  $2\pi/60$  (rad/s)

### 6.9.2. Analog monitor output

There are 2 analog monitor channels provided for users to check the required signals. The contents and settings of monitor output are described in the table below.

Name	Abbr.	Sign	Setting range	Description
Analog monitor output	MOD	PC14	0000h ~0909h	<p>There are 2 monitor outputs, ch1 and ch2.</p> <p><input type="text" value="0"/> <input type="text" value="ch2"/> <input type="text" value="0"/> <input type="text" value="ch1"/></p> <p>The setting values and their corresponding output are listed below.</p> <p>0: Motor speed (scale: <math>\pm 10V / (\text{double rated speed})</math>)</p> <p>1: Generated torque (scale: <math>\pm 10V / \text{max.torque}</math>)</p> <p>2: Speed command (scale: <math>\pm 10V / (\text{double rated speed})</math>)</p> <p>3: Effective load ratio (scale: <math>\pm 10V / \pm 300\%</math>)</p> <p>4: Pulse command frequency (scale: <math>\pm 10V / 500\text{kpps}</math>)</p> <p>5: Current command (scale: <math>\pm 10V / \text{max.current command}</math>)</p> <p>6: DC Bus voltage (scale: <math>\pm 10V / 400V</math>)</p> <p>7: Pulse command error(scale: <math>\pm 10V / 4194304</math> pulse)</p> <p>8: Pulse command error(scale: <math>\pm 10V / 10000</math> pulse)</p> <p>9: Pulse command error(scale: <math>\pm 10V / 100</math> pulse)</p>

Example :

If the PC14 is set as 0000h and the current speed of motor is forward rotation 3000 rpm, a +5V signal would be measured on CN1-30 and LG. On the other hand, a -5V signal would be detected if the speed

of motor is reverse rotation -3000 rpm. The mentioned example above is without any adjustment of PC28 to PC31.

#### Voltage offset of analog monitor

The parameter PC28 and PC29 are used to set the compensation to eliminate the bias voltages of analog monitor output MON1 and MON2.

Name	Abbr.	Sign	Setting range	Description	Unit	Initial value
Analog monitor ch1 offset	MO1	PC28	-999 ~999	Used to set the offset voltage of the analog monitor ch1 output.	mV	0
Analog monitor ch2 offset	MO2	PC29	-999 ~999	Used to set the offset voltage of the analog monitor ch2 output.	mV	0

Here is an example.

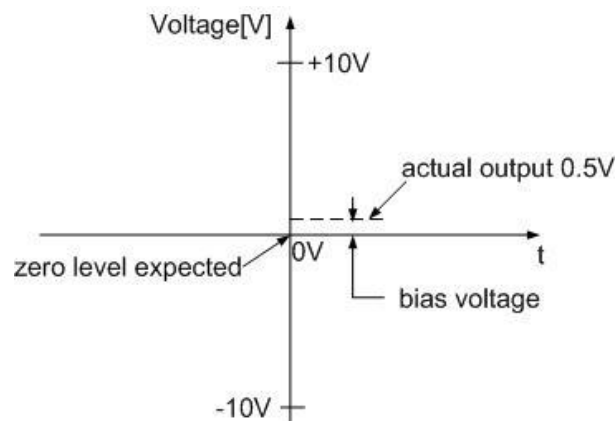

It assumes that the motor speed is 0 rpm, and then the analog monitor voltage output should be 0 V. This difference above is 0.5 V, which could be compensated by setting PC28 or PC29 as -500mV so the MOD analog voltage would be corrected.

#### Output proportion of analog monitor

The output proportion of analog monitor enables users to set the ratio of the analog voltage output to be viewed. Relevant parameters are presented in the table below.

Name	Abbr.	Sign	Setting range	Description	Unit	Initial value
Analog monitor ch1 output proportion	MOG1	PC30	0 ~100	Set the output proportion of analog monitor ch1.	%	100
Analog monitor ch2 output proportion	MOG2	PC31	0 ~100	Set the output proportion of analog monitor ch2.	%	100

If the current rotation speed is +3000 rpm and monitor scale is  $\pm 10V/$  (double rated speed), the analog output should be +5V if MOG1 or MOG2 is set as initial value (100%). So, the analog monitor output voltage by MON should be +10V in case of 50% setting value applied.

The equation is:

$$\text{Monitor output} = \text{monitoring value} \times \langle \text{monitor scale} \rangle \div \text{MOG}$$

### 6.9.3. Operation of electromagnetic brake interlock

MBR is described: (1) MBR OFF, the brake locks the motor shaft. (2) MBR ON, the brake releases the motor shaft. PC16 decides SON delay time to make MBR activated.

- ◆ MBR enables/disables electromagnetic contactor to release/lock the motor shaft.
- ◆ The coil of electromagnetic brake is without polarity.
- ◆ Do not use the inner +24V power (VDD) to drive the electromagnetic brake.
- ◆ If users control the electromagnetic brake without MBR, refer to the operation sequence below.
- ◆ If DO MBR function is applied, make it valid by PA01=01□□ setting.

The operation sequence of electromagnetic brake is plotted below.

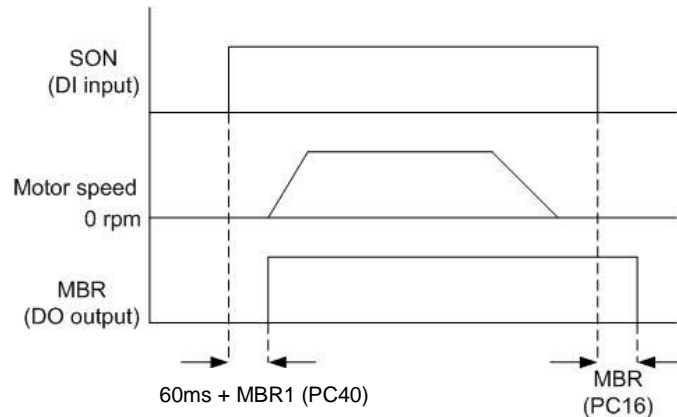

Wiring diagram of electromagnetic brake (MBR DO applied)

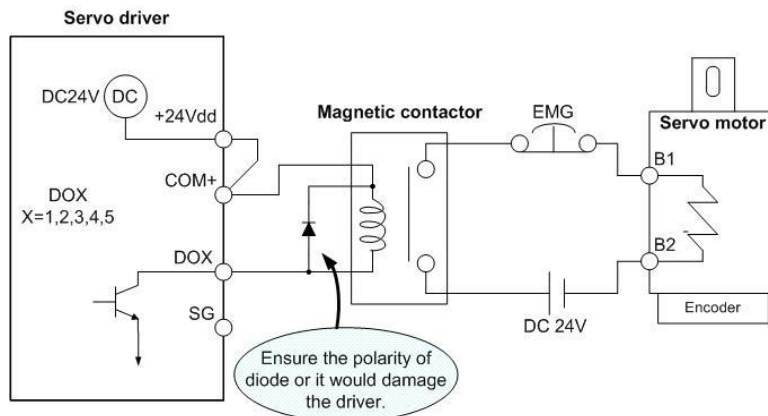

### Specification of electromagnetic brake

Motor type	SMA series								
	L010B	L020B	L040B	L075B	M050B	M100B	M150B	M200B	M350B
Brake type	Spring brake (Normal locked)								
Rated voltage (V)	DC 24V								
Rated power (W)	6.3	7.9	8.6	19.3			34		
Rated current (A)	0.24	0.32	0.35	0.8			1.41		
Friction Tq (N · m)	0.3	1.3	2.4	8.5			45		

**⚠ CAUTION** • Not attempt to use electromagnetic brake to decelerate a running motor.

## 7. PR (procedure) sequence control introductions

### 7.1. PR introduction

When Pr control mode is applied, the motion stroke is composed of one position command or multiple position commands. SDE servo drives provide 64 motion strokes, hereinafter referred to as PR, which are programmable by users. One is home return PR and others are 63 PRs. There are 3 ways to trigger these PRs.

1. STANDARD:

POS1 ~ POS6 decide the PR, the CTRG is used to trigger.

2. EVENT:

Rising edge or falling edge of EV1 to EV4 to trigger. Refer to PF83 and PF84 setting.

3. SOFTWARE:

PF82 receives the PR NO. then trigger.

### 7.2. PR differences in SDA and SDE

	PR in SDA servo drive	PR in SDE servo drive
Command amount	8 individual positions	1 home return PR 63 PRs (PATH#01~PATH#63)
Command type	Position	Positioning/speed/JUMP/WRITE/index
Position command	absolute or incremental	Absolute/incremental/relative (switchable)
Acc./Dec. time	1 set	16 sets
Speed option	8 sets	16 sets
Trigger source	DI: POSx + CTRG x=1,2,3,4,5,6	DI: POSx + CTRG, x=1,2,3,4,5,6 EVENT : EV1~EV4 SOFTWARE : PF82
Command format	revolutions, pulses	32 bits data ( Units are depended on varied modes)
Home function	Auto-execution after Power ON SHOM DI activated	Auto-execution after Power ON SHOM DI activated PR0 (PATHR#0) is home return stroke. Program PR1~PR60 to execute home function.
Software limit	without	with

### 7.3. DI/DO and sequences

DI signals:

CTRG, SHOM, STOP, POS1~POS6, ORGP, LSP, LSN, EV1~EV4

DO signals:

CMDOK, MC\_OK, INP, ALM, OVF, SWPL, SWNL

The sequence relation between INP, CMDOK and MC\_OK is plotted below.

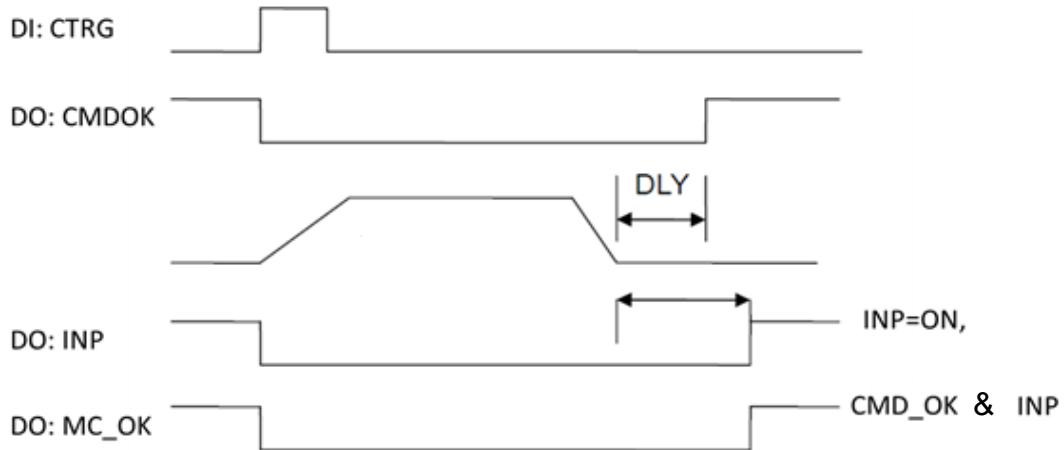

Explanation of PR trigger:

	Command source	Description
STANDARD	POSx + CTRG, x=1~6	Use POS1~ POS6 to assign a specific PR. Then apply CTRG to trigger the PR execution. Applicable occasion: PC or PLC controls the servo drive via DI signals.
PRIORITY	STOP, SHOM	When STOP is activated, the stroke would be held. When SHOM is activated, home return would be executed.
EVENT	EV1~EV4	With 4 events' rising or falling edge to trigger the specific PR. PF83 setting recognizes the event rising edge trigger. PF84 setting recognizes the event falling edge trigger. Applicable occasion: sensors, preset sequences
SOFTWARE	PF82	Set PF82 as the demand PR number and it will trigger the specific stroke. P5-07 can be set through the keypad / communication (Panel/communication software could operate this PR trigger.) Applicable occasion: PC controls the servo drive via communication.



## 7.4. Relevant parameter settings of PR

Speed command: PF33~PF48, total 16 sets.

Bit	15~0
PF33~PF48	1~3000rpm

Acceleration/Deceleration time: PF49~PF64, total 16 sets.

Bit	15~0
PF49~PF64	1~65500ms

Delay time: PF65~PF80, total 16 sets.

Bit	15~0
PF65~PF80	1~32767ms

### Relevant parameter settings

	Description
PA04	Home moving option
PA08	Home moving high speed option 1
PA09	Home moving high speed option 2
PE01	Origin return definition
PE02	Origin offset value definition
PF81	Protection trigger deceleration time
PF82	PR trigger register
PF86	Software forward stroke limit
PF87	Software reverse stroke limit
PE03~PE98	PATH#01~ PATH#48 stroke settings
PF01~PF30	PATH#49~ PATH#63 stroke settings

## PR motion stroke definition

Home return, PATH#01~PATH#63; there are total 64 PRs which are composed of 128 parameters. (PE01~PE98, PF01~PF30) Each PR occupies two parameters, which the lower number parameter is function option and the higher number parameter is PR data. Others PRs are introduced as follows. PATH#01 setting is used as an example to describe the application instruction.

Parameter \ Bit	31~28	27~24	23~20	19~16	15~12	11~8	7~4	3~0
PE03 (lower)								<b>TYPE</b>
PE04 (higher)	Data (32bit)							

TYPE:

- 1: Constant speed application
- 2: Position application
- 3: Auto position application
- 7: JUMP
- 8: WRITE
- A: INDEXING

The only difference between TYPE2 and TYPE3 is that TYPE3 is able to execute the following PR automatically when the preceding PR is done.

### Constant speed application

The relevant parameter settings are listed below.

Parameter \ Bit	31~28	27~24	23~20	19~16	15~12	11~8	7~4	3~0
PE03	X	X	<b>DLY</b>	X	<b>DEC</b>	<b>ACC</b>	<b>OPT</b>	<b>1</b>
PE04	Data (32bit): Target speed (Speed unit is determined with the OPT setting.)							

※When this constant speed application is performed, servo motor accelerates or decelerate from current speed to reach the target speed then keeps running.

**OPT** setting:

OPT						
Bit 7	Bit 6		Bit 5		Bit 4	
X	UNIT		AUTO		INS	
	1	0	1	0	1	0

※ When the TYPE is set to 1 ~ 3, it can accept STOP signal.

INS=1: It indicates that the current PR would immediately replace the previous PR.

AUTO=1: When the target speed is reached, the next PR would be executed automatically.

UNIT=0: The unit is 0.1 rpm.

UNIT=1: The unit is PPS. (Pulse per second)

**ACC / DEC setting:**

Acc. /Dec. value	F	E	D	C	~	3	2	1	0
Corresponding Parameter	PF64	PF65	PF64	PF63	~	PF52	PF51	PF50	PF49

**DLY setting:**

DLY value	F	E	D	C	~	3	2	1	0
Corresponding Parameter	PF80	PF79	PF78	PF77	~	PF68	PF67	PF66	PF65

**Position application**

The relevant parameter settings are listed below.

Parameter \ Bit	31~28	27~24	23~20	19~16	15~12	11~8	7~4	3~0
PE03	X	X	DLY	<b>SPD</b>	Acc. / Dec.		<b>OPT</b>	2 or 3
PE04	Target position 32bit data, unit: pulse							

**OPT setting:**

OPT							
Bit 7		Bit 6		Bit 5		Bit 4	
CMD			OVLP		INS		
00, 01, 10			1	0	1	0	

CMD		
Bit 7	Bit 6	Explanation
0	0	Absolute: Command = Data
0	1	Relative: Command = current feedback + Data
1	0	Incremental: Command = Previous position + Data

※ When the TYPE is set to 1 ~ 3, it can accept STOP signal.

INS=1: It indicates that the current PR would immediately replace the previous PR.

OVLP=1: The overlap of next PR is allowance. When this is applied, DLY should be set as 0.

CMD: Refer to the previous table.

**SPD setting:**

SPD value	F	E	D	C	~	3	2	1	0
Corresponding Parameter	PF48	PF47	PF46	PF45	~	PF36	PF35	PF34	PF33

**JUMP** : TYPE=7, it is used to jump to the assigned PR.

Parameter \ Bit	31~28	27~24	23~20	19~16	15~12	11~8	7~4	3~0
PE03	X	X	DLY	X	Acc. / Dec.		<b>OPT</b>	7
PE04	PATH#: The assigned PRx, x=0~63							

**OPT** setting:

OPT			
Bit 7	Bit 6	Bit 5	Bit 4
X	X	X	INS
			1    0

INS=1: It indicates that the current PR would immediately replace the previous PR.

**WRITE** : TYPE=8, write the assigned PR to the specific parameter

Parameter \ Bit	31~28	27~24	23~20	19~16	15~12	11~8	7~4	3~0
PE03	X	<b>SOUR</b>	DLY	<b>Destination parameters</b>		<b>OPT</b>	7	
PE04	<b>Source</b> (constant or parameter number)							

**OPT** setting:

OPT			
Bit 7	Bit 6	Bit 5	Bit 4
X	ROM	AUTO	INS
	1    0	1    0	1    0

INS=1: It indicates that the current PR would immediately replace the previous PR.

AUTO=1: When the current PR is done, the next PR would be executed automatically.

ROM=0: The relevant parameter modification is not saved into EEPROM.

ROM=1: The relevant parameter modification will be saved into EEPROM.

**Destination parameters** setting: Parameter group and number could be assigned.

OPT		
Bit 19~16	Bit 15~12	Bit 11~8
Group	Parameter No.	
A→1	P□05→05	
B→2	P□45→45	
C→3	P□98→98	
D→4	P□77→77	
E→5		
F→6		

**SOUR** setting: The following table explains the data source and write destination

SOUR				Explanation	
Bit 27	Bit 26	Bit 25	Bit 24	Data source	Write destination
X	0	X	X	Constant	P□XX
	1			P□XX	P□XX

□=A~G, Parameter group, XX=parameter number

**Source** setting: Source definition depends on SOUR setting.

Setting	Bit	Source							
		31~28	27~24	23~20	19~16	15~12	11~8	7~4	3~0
SOUR=0		Constant							
SOUR=1		Reserve bit (0x00000)				P_grp		P_idx	

P\_grp, P\_idx: The specified parameter group and number.

When the value of P\_grp exceeds the setting range, the fault AL61 will occur.

When the value of P\_idx exceeds the setting range, the fault AL62 will occur.

**INDEXING**: TYPE=A, it is used to perform turret or rotation table application

Parameter	Bit	31~28	27~24	23~20	19~16	15~12	11~8	7~4	3~0
		PE03	X	<b>OPT2</b>	DLY	SPD	Acc. / Dec.		<b>OPT</b>
PE04		<b>Data:</b> 0~4194303, unit: pulse							

**OPT** setting:

OPT			
Bit 7	Bit 6	Bit 5	Bit 4
00: always forward (CCW)		OVLP	
01: always reverse (CW)		S_LOW	
10: the shortest path		1	0
		1	0

INS=1: It indicates that the current PR would immediately replace the previous PR.

OVLP=1: The overlap of next PR is allowance. When this is applied, DLY should be set as 0.

**OPT2** setting:

OPT			
Bit 27	Bit 26	Bit 25	Bit 24
X	AUTO	S_LOW	

S\_LOW=0: It indicates that the speed unit is 0.1 rpm.

S\_LOW=1: It indicates that the speed unit is 0.01 rpm.

S\_LOW=2: It indicates that the speed unit is 1 rpm.

AUTO=1: When the current PR is done, the next PR would be executed automatically.

**Data setting:**

Data
Pulse: 0~1048575

**Home return** : This is composed of PE01 and PE02.

Parameter \ Bit	31~28	27~24	23~20	19~16	15~12	11~8	7~4	3~0
PE01	<b>BOOT</b>	X	DLY	X	Acc. / Dec.		<b>PATH</b>	
PE02	<b>ORG_DEF: 32bit</b>							

**OPT setting:**

OPT		
Bit 7~4	Bit 3~0	Explanation
0	0	After home return, then the servo motor stops.
0	1	After home return, then the servo motor starts to run PATH#01.
0	2	After home return, then the servo motor starts to run PATH#02.
0	3	After home return, then the servo motor starts to run PATH#03.
~	~	~
3	D	After home return, then the servo motor starts to run PATH#61.
3	E	After home return, then the servo motor starts to run PATH#62.
3	F	After home return, then the servo motor starts to run PATH#63.

**BOOT** setting: Enable or disable home return when the servo drive is power on.

BOOT	
Bit 31~28	Explanation
0	Not to execute home return.
1	Execute home return.

**ORG\_DEF** setting: To define the origin coordinate in pulse counts, it may not be 0.

ORG_DEF
Pulse: $-2^{31} \sim 2^{31}-1$

SDE series does not provide the SDA home return functions which the motor return to Z pulse position. After home sensor or Z pulse is found, the motor must accelerate to stop. Commonly, the motor stop position will be a little ahead over the Z pulse position.

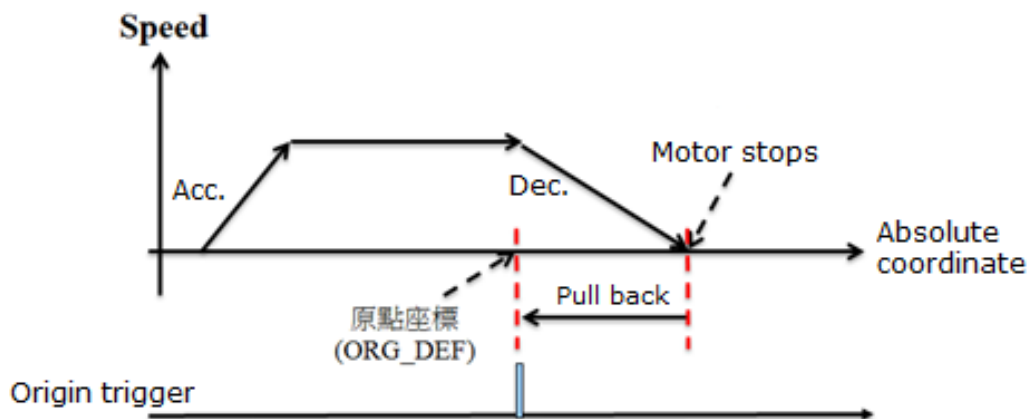

Do not return to Z pulse: Only execute home return.

Return to Z pulse: Set PATH= a non-zero value and set absolute position command= ORG\_DEF.

Position offset values are not defined when performing homing operation. After homing operation, the position offset values can be set as a dedicated PR.

## 8. Communication functions

### 8.1. Communication interface and wiring

The SDE servo drive equips RS-485 and plug-play USB serial communication functions. These functions could be used to perform servo operation, parameter changing, monitor function, etc. However, the RS-485 communication and USB could not be used in synchronization. The wirings are demonstrated below.

#### RS-485

##### (1) Outline:

Up to 32 devices of servo drives from stations 1 to 32 could be operated on the same bus.

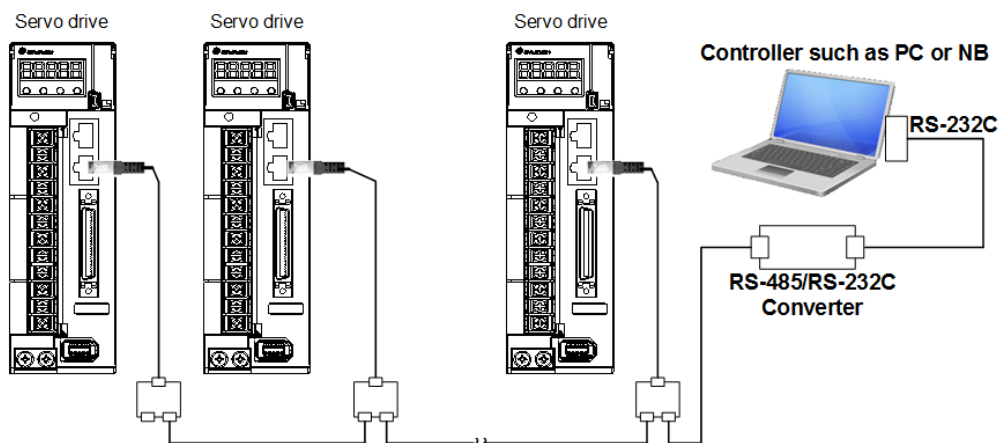

##### (2) Wiring diagram:

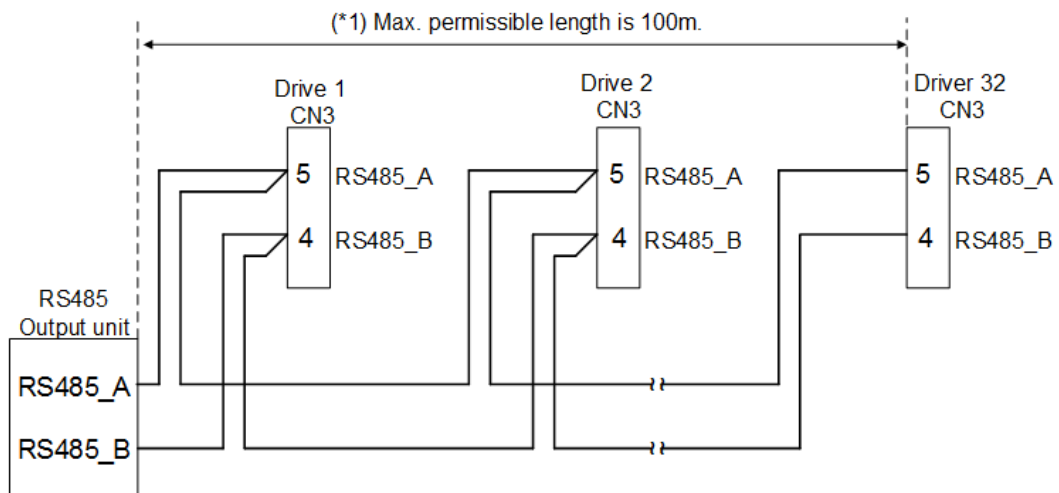

(\*1) Suitable for the environment with less noise interference. If communication transmission speed is higher than 38400bps, use the wires shorter than 15m.

Recommendation: To connect ground terminal of RS-485/RS-232C converter and GND (pin1,pin2) of CN3 could reduce communication failure if necessary.



## USB

### (1) Outline:

Use the standard Mini-USB cable to perform.

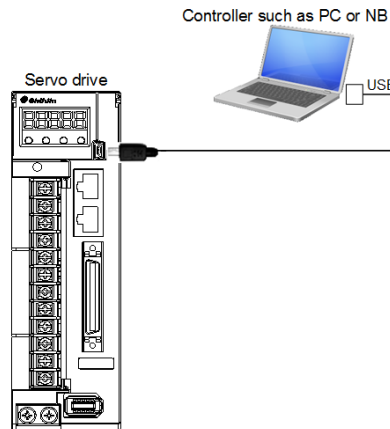

## 8.2. Relevant parameters of communication

When RS-485 communication is performed, the related settings are described below.

### (1) Communication device number (PC20)

Name	Abbr.	Sign	Setting range	Description
Communication device number	SNO	PC20	1 ~32	If two drives occupy the same device number, the communication could not be performed.

### (2) Mode option (PC21)

0	0	0	x
---	---	---	---

0: reply within 1 ms

1: reply after 1 ms

### (3) Communication protocol option (PC22)

0	0	0	x
---	---	---	---

0: 7 data bit, <b>No</b> parity, 2 stop bit	(Modbus, ASCII Mode)
1: 7 data bit, <b>Even</b> parity, 1 stop bit	(Modbus, ASCII Mode)
2: 7 data bit, <b>Odd</b> parity, 1 stop bit	(Modbus, ASCII Mode)
3: 8 data bit, <b>No</b> parity, 2 stop bit	(Modbus, ASCII Mode)
4: 8 data bit, <b>Even</b> parity, 1 stop bit	(Modbus, ASCII Mode)
5: 8 data bit, <b>Odd</b> parity, 1 stop bit	(Modbus, ASCII Mode)
6: 8 data bit, <b>No</b> parity, 2 stop bit	(Modbus, RTU Mode)
7: 8 data bit, <b>Even</b> parity, 1 stop bit	(Modbus, RTU Mode)
8: 8 data bit, <b>Odd</b> parity, 1 stop bit	(Modbus, RTU Mode)

### (4) Baud rate (PC22)

0	0	y	0
---	---	---	---

0: 4800 bps	4: 57600 bps
1: 9600 bps	5: 115200 bps
2: 19200 bps	
3: 38400 bps	

### 8.3. Modbus protocol

When communication between a computer and several drives is going to be performed, every drive should be set its device number. Then the computer could control individual drive according to its device number. The protocol of Shihlin drive is standard Modbus protocol. There are two modes : ASCII(American Standard Code for information interchange) mode and RTU (Remote Terminal Unit) mode, users could change the mode by setting the PC22 value.

#### A. ASCII mode

##### (a) Coding signification

A 8-bit data(a byte) is expressed with 2 ASCII character. For example, 75h is expressed with ASCII code “37h” and ASCII code “35h”.The ASCII codes ‘0’ to ‘9’ and ‘A’ to ‘F’ are listed below.

Character	‘0’	‘1’	‘2’	‘3’	‘4’	‘5’	‘6’	‘7’
ASCII code	30h	31h	32h	33h	34h	35h	36h	37h
Character	‘8’	‘9’	‘A’	‘B’	‘C’	‘D’	‘E’	‘F’
ASCII code	38h	39h	41h	42h	43h	44h	45h	46h

##### (b) Frame signification

11-bit frame (suitable for 8-bit data length)

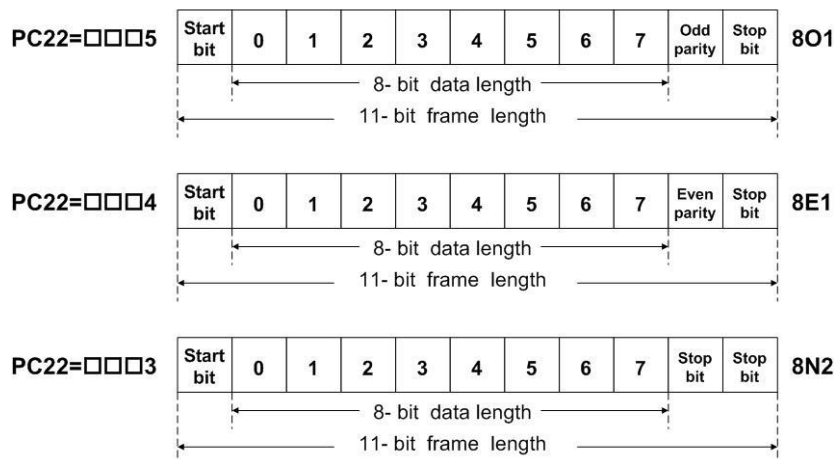

10-bit frame (suitable for 7-bit data length)

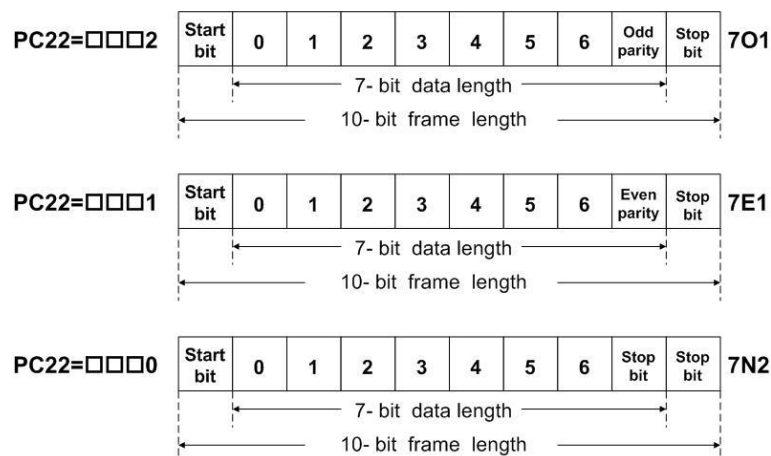

**(c) Data packet structure**

Byte sign	Name	Description
STX	Start code	“:”(ASCII code 3Ah)
ADR	Device number	1 byte is composed of 2 ASCII code bytes.
CMD	Command code	1 byte is composed of 2 ASCII code bytes.
DATA(n-1)	Data code	The length of n words is equal to the one of 2n bytes.(n<=29) So, there are 4n ASCII code bytes.
.....		
DATA(0)		
LRC	LRC check value	1 byte is composed of 2 ASCII code bytes.
End1	End code 1	“CR”(ASCII code 0Dh)
End0	End code 0	“LF”( ASCII code 0Ah)

Communication data formats are described below.

**STX**

“:” character

**ADR**

The address code is from 1 to 32. For example, the expression of number 18(hexadecimal 12h) is divided into “1” and “2” in ASCII code. The address code 18 is expressed as 31h and 32h.

**CMD and DATA**

The DATA are varied according to different Command codes. To read 2 words which start address is 0100h from device number 1 as an example is described below.

Command code: 03h, read data

Command(host):

STX		:
ADR		'0'
		'1'
CMD		'0'
		'3'
DATA	start address	'0'
		'1'
		'0'
		'0'
	word length	'0'
		'0'
		'2'
		'0'
LRC		'F'
		'9'
End1		0Dh
End0		0Ah

Response(slave):

STX		:
ADR		'0'
		'1'
CMD		'0'
		'3'
DATA	byte length	'0'
		'4'
	content of address 0100h	'0'
		'1'
		'0'
		'2'
	content of address 0101h	'1'
		'2'
		'2'
		'1'
LRC		'C'
		'2'
End1		0Dh
End0		0Ah

Command code: 06h, write data

To write "325"(0145h) into the drive which device number is 1 and start address is 0100h.

Command(host):

STX		:
ADR		'0'
		'1'
CMD		'0'
		'6'
DATA	start address	'0'
		'1'
		'0'
		'0'
	written data (word)	'0'
		'1'
		'4'
		'5'
LRC		'B'
		'2'
End1	0Dh	
End0	0Ah	

Response(slave):

STX		:
ADR		'0'
		'1'
CMD		'0'
		'6'
DATA	start address	'0'
		'1'
		'0'
		'0'
	written data (word)	'0'
		'1'
		'4'
		'5'
LRC		'B'
		'2'
End1	0Dh	
End0	0Ah	

**LRC calculation :**

ASCII mode uses LRC (Longitudinal Redundancy Check) to detect errors. LRC method computes the 2's complement of the sum from ADR code to the last data code. The 2's complement is a byte value which the overflow part neglected. Here is a case to describe the rule.

ADR		'0'	<p>Calculation of LRC detection value:</p> <ol style="list-style-type: none"> <li>To compute the sum of ADR code to last data code. <math>01h+03h+01h+04h+00h+02h=0Bh</math></li> <li>If the sum is byte-overflow, neglect the overflow part.</li> <li>Compute the 2's complement. <math>100h-0Bh=F5h</math></li> <li>"F5h" is the LRC detection value.</li> </ol>
		'1'	
CMD		'0'	
		'3'	
DATA	start address	'0'	
		'1'	
		'0'	
		'4'	
	data written (word)	'0'	
		'0'	
		'0'	
		'2'	
LRC		'F'	
		'5'	

End1, End0 (data packet ended):

Use "0Dh" and "0Ah" to denote the end of communication data packet.

## B. RTU mode

### (a) Coding signification

Data are expressed in hexadecimal characters. For example, “168” is expressed as A8h, “99” is expressed as 63h.

### (b) Data packet structure

Byte sign	Name	Description
STX	-	To keep an idle more than 6mS
ADR	Device number	1 byte
CMD	Command code	1 byte
DATA(n-1)	Data code	n words is equal to 2n bytes.(n<=29)
.....		
DATA(0)		
CRC_L	CRC value low byte	Low byte of CRC check code
CRC_H	CRC value high byte	High byte of CRC check code
End	-	To keep an idle more than 6mS

#### STX

Keep an idle more than 6mS.

#### ADR

The address code is from 1 to 32. For example, number “18” is expressed as 12h.

#### CMD and DATA

The DATA are varied according to different Command codes.

#### **Command code: 03h, read data**

For example, to read 2 words which start address is 0200h from device number 1 is described below.

Command(host):

ADR	01h	
CMD	03h	
DATA	start address	02h
		00h
	word length	00h
		02h
CRC_L	C5h	
CRC_H	B3h	

Response(slave):

ADR	01h	
CMD	03h	
DATA	byte length	04h
	content of address 0200h	00h
		B1h
	content of address 0201h	1Fh
40h		
CRC_L	A3h	
CRC_H	D4h	

**Command code: 06h, write data**

For example, to write “100” (0064h) into the drive which device number 1 and start address 0200h.

Command(host):

ADR		01h
CMD		06h
DATA	start address	02h
		00h
	written data	00h
		64h
CRC_L		89h
CRC_H		99h

Response(slave):

ADR		01h
CMD		06h
DATA	start address	02h
		00h
	written data	00h
		64h
CRC_L		89h
CRC_H		99h

**CRC calculation:**

RTU mode uses CRC (Cyclical Redundancy Check) to detect errors.

CRC method to decide the check value is described below.

Step 1: Load a 16-bit register (called CRC register) with FFFFh.

Step 2: Exclusive OR the first 8-bit byte of the command message with the lower byte of CRC register, putting the result in the CRC registers.

Step 3: Check the LSB of CRC register. If it is 0, shift the CRC register one bit to the right. If it is 1, shift the CRC register one bit to the right then Exclusive OR the CRC register with A001h.

Step 4: Repeat step 3 until eight shifts have been performed. When this is done, a complete 8-bit byte will have been processed, then perform step 5.

Step 5: Repeat step 2 to step 4 for the next 8-bit byte of the command message.

Continue doing this until all bytes have been processed. The final contents of the CRC register are the CRC value. It should be noticed that the low-byte should be transmitted before high-byte.

For example, reading 2 words from address 0101h of the drive with address 01H. The final content of the CRC register from ADR to last data character is 3794H, and then the command message is shown as follows. What should be noticed is that 94H have to be transmitted before 37H.

ADR		01h
CMD		03h
DATA	start address	01h
		01h
	written data	00h
		02h
CRC_L		<b>94h</b>
CRC_H		<b>37h</b>

**End:**

To keep an idle more than 6ms as an end.

CRC calculation example:

The following is an example of CRC generation using C language. The function takes two variables.

unsigned char\* data;

unsigned char length

This function returns the CRC value as unsigned integer type.

```
unsigned int crc_chk(unsigned char* data, unsigned char length)
{
    int j;
    unsigned int reg_crc=0xFFFF;
    while( length-- )
    {
        reg_crc^= *data++;
        for (j=0; j<8; j++ )
        {
            if( reg_crc & 0x01 )          /*LSB(bit 0 ) = 1 */
                reg_crc = (reg_crc >> 1)^0xA001;
            else
                reg_crc = (reg_crc>>1);
        }
    }
    return reg_crc;
}
```

### (c) Command code and exception code

The Command code and exception code of Shihlin servo drive are described below.

Command code	Description
03h	read data
06h	write data
08h	diagnostic mode
10h	write data (multiple)

Command code 03h denotes data reading, the maximum permissible length is 29 words.

Command code 06h denotes data writing, a word writing.

Command code 08h denotes the diagnostic mode which could check if communication normal or not.

Command code 10h denotes data writing, multiple words writing.

When the communication is performed between a host and the servo drives, wrong commands or wrong address or over-range would cause the exception response with particular format.

Exception code (ECP)	Description
01h	Command code error
02h	Parameter address error
03h	Parameter range error

Exception code 01h denotes wrong command code transmitted from the host computer.

Exception code 02h denotes wrong parameter address transmitted from the host computer.

Exception code 03h denotes the over-range parameter setting request.

If the received data are wrong, the drive would send back the command code which is the original one added to 80h.

#### (a) ASCII mode

STX	‘:’
ADR	‘0’
	‘1’
CMD	‘8’
	‘6’
ECP	‘0’
	‘2’
LRC	‘7’
	‘7’
End1	CR
End0	LF

#### (b) RTU mode

ADR	01h
CMD	86h
ECP	02h
CRC_L	C3h
CRC_H	A1h



## 8.4. Communication parameter write-in and read-out

### (1) Status monitor (read only)

Address	Content	Data length
0x0000	Motor feedback pulse [pulse]	2 word
0x0002	Command pulses [rev]	2 word
0x0004	Accumulative pulses error [pulse]	2 word
0x0006	Command pulse frequency [Hz]	2 word
0x0008	Motor speed [rpm]	2 word
0x000A	Analog speed command/limit voltage [V]	2 word
0x000C	Speed input command/limit [rpm]	2 word
0x001E	Analog Torque command/limit voltage [V]	2 word
0x0010	Torque input command/limit [%]	2 word
0x0012	Effective load ratio [%]	2 word
0x0014	Peak load ratio [%]	2 word
0x0016	DC bus voltage [V]	2 word
0x0018	Load to motor inertia ratio [times]	2 word
0x001A	Instantaneous torque [%]	2 word
0x001C	Regeneration load ratio [%]	2 word
0x0020	Pulses of Z phase reference acknowledged [pulse]	2 word
0x0022	Translated command pulses [pulse]	2 word
0x0024	Translated motor feedback pulses [pulse]	2 word
0x0026	Translated accumulative pulses error [pulse]	2 word

## (2) Digital IO monitor (read only)

### (a) DI I/O status

Address	Content	Data length
0204h	To show the on/off status of DI.	1 word

bit	b15	b14	b13	b12	b11	b10	b9	b8
CN1 pin No.	-	-	-	-	CN1_42	CN1_41	CN1_23	CN1_22
Signal name	-	-	-	-	DI12	DI11	DI10	DI9

bit	b7	b6	b5	b4	b3	b2	b1	b0
CN1 pin No.	CN1_21	CN1_20	CN1_19	CN1_18	CN1_17	CN1_16	CN1_15	CN1_14
Signal name	DI8	DI7	DI6	DI5	DI4	DI3	DI2	DI1

This DI 0/1 status is the conclusion of PD16 (DI on/off control source option) and PD25 (Communication control DI on/off). See the function description of PD25 for a detail.

Address	Content	Data length
0205h	To show the on/off status of DO.	1 word

bit	b7	b6	b5	b4	b3	b2	b1	b0
CN1 pin No.	-	-	CN1_46	CN1_45	CN1_44	CN1_43	CN1_42	CN1_41
Signal name	-	-	DO6	DO5	DO4	DO3	DO2	DO1

### (b) IO pin function

Address	Content	Data length
0206h ~020Dh	To display the pin function programmed of DI.	1 word

#### Address: 0x0206

bit No.	b15	b14	b13	b12	b11	b10	b9	b8	b7	b6	b5	b4	b3	b2	b1	b0
DI	DI1							DI2								
Function	0x00 to 0x2F							0x00 to 0x2F								

#### Address: 0x0207

bit No.	b15	b14	b13	b12	b11	b10	b9	b8	b7	b6	b5	b4	b3	b2	b1	b0
DI	DI3							DI4								
Function	0x00 to 0x2F							0x00 to 0x2F								

Address: 0x0208

bit No.	b15	b14	b13	b12	b11	b10	b9	b8	b7	b6	b5	b4	b3	b2	b1	b0
DI	DI5							DI6								
Function	0x00 to 0x2F							0x00 to 0x2F								

Address: 0x0209

bit No.	b15	b14	b13	b12	b11	b10	b9	b8	b7	b6	b5	b4	b3	b2	b1	b0
DI	DI7							DI8								
Function	0x00 to 0x2F							0x00 to 0x2F								

Address: 0x020A

bit No.	b15	b14	b13	b12	b11	b10	b9	b8	b7	b6	b5	b4	b3	b2	b1	b0
DI	DI9							DI10								
Function	0x00 to 0x2F							0x00 to 0x2F								

Address: 0x020B

bit No.	b15	b14	b13	b12	b11	b10	b9	b8	b7	b6	b5	b4	b3	b2	b1	b0
DI	DI11							DI12								
Function	0x00 to 0x2F							0x00 to 0x2F								

Address : 0x020C

bit No.	b15	b14	b13	b12	b11	b10	b9	b8	b7	b6	b5	b4	b3	b2	b1	b0
DI	-	DO3					DO2					DO1				
Function	-	0x00 to 0x1F					0x00 to 0x1F					0x00 to 0x1F				

Address : 0x020D

bit No.	b15	b14	b13	b12	b11	b10	b9	b8	b7	b6	b5	b4	b3	b2	b1	b0
DI	-	DO6					DO5					DO4				
Function	-	0x00 to 0x1F					0x00 to 0x1F					0x00 to 0x1F				

**(c) Control mode**

Address	Content	Data length
0x0200	bit0: Servo ready status (0: Servo OFF, 1: Servo ON)	1 word
0x0201	Use bit0~bit3 to display current control mode of servo drive. 0: <b>Pt</b> mode (external pulse-train command) 1: <b>Pr</b> mode (inner register command in <i>absolute</i> type) 2: <b>Pr</b> mode (inner register command in <i>incremental</i> type) 3: <b>S</b> mode (speed mode) 4: <b>T</b> mode (torque mode) 6 : Turret mode	1 word

**(3) Alarm information (read only)**

Address	Content	Data length
0x0100	Current alarm.	1 word
0x0101	The last alarm.	1 word
0x0102	The 2nd alarm in the past.	1 word
0x0103	The 3rd alarm in the past.	1 word
0x0104	The 4th alarm in the past.	1 word
0x0105	The 5th alarm in the past.	1 word
0x0106	The 6th alarm in the past.	1 word
0x0107	The 7th alarm in the past.	1 word
0x0108	The 8th alarm in the past.	1 word
0x0109	The 9th alarm in the past.	1 word
0x010A	The 10th alarm in the past.	1 word

**(4) Alarm clear (readable and writable)**

Address	Content	Data length
0x0130	Clear current alarm if "0x1EA5" is written into this address. Transmit current alarm code back if this address is read.	1 word
0x0131	Clear all alarm histories if "0x1EA5" is written into this address. Transmit last alarm back if this address is read.	1 word

**(5) Parameter write-in and read-out (readable and writable)**

Address	Content	Data length
0x0300 ~0x0363	PA□□: 50 parameters	2 words
0x0400 ~0x0463	PB□□: 50 parameters	2 words
0x0500 ~0x0577	PC□□: 60 parameters	2 words
0x0600 ~0x064F	PD□□: 40 parameters	2 words
0x0700 ~0x07C5	PE□□: 99 parameters	2 words
0x0800 ~0x08C5	PF□□: 99 parameters	2 words

**(6) Factory-set recovery (readable and writable)**

Address	Content	Data length
0x0140	All parameters would be recovered factory-set 1 second later once “1EA5h” being written. To read this address, the result of “1” means the recovery is processing. “0” means the completion of recovery.	1 word

**(7) DI contact control (readable and writable)**

Step 1: Select DI on/off control source option

Address	Content	Data length
0x061E	DI on/off control source option (PD16) Each bit is to decide the on/off control source of corresponding DI. Bit0 is corresponding to DI1, bit1 is corresponding to DI2, bit2 is corresponding to DI3, and so on. 0: The specified DI is controlled by the actual wirings. 1: The specified DI is controlled by communication software. (PD25)	2 word

Step 2: Write command to control on/off state of each DI pin

Address	Content	Data length
0x0630	Use bit value to control the corresponding Di on/off state. 0: denotes “off” state. 1: denotes “on” state.	2 words

bit No.	b12~b31	b11	b10	b9	b8	b7	B6	b5	b4	b3	b2	b1	b0
DI	<b>0</b>	DI12	DI11	DI10	DI9	DI8	DI7	DI6	DI5	DI4	DI3	DI2	DI1

**(8) DO forced output (readable and writable)**

Step 1: Check the drive without any alarm occurrence or Servo ON activated.

Address	Content	Data length				
0x0900	<table border="1" style="display: inline-table; vertical-align: middle;"> <tr> <td>0</td> <td>z</td> <td>y</td> <td>x</td> </tr> </table> x=0 Servo OFF, x=1 Servo ON;    zy: Alarm code	0	z	y	x	1 word
0	z	y	x			

Step 2: To write 0x0002

Address	Content	Data length
0x0901	0x0000: To quit this test mode 0x0001: Reserved 0x0002: DO forced output 0003h: JOG test 0004h: Positioning test	1 word

Step 3: To write the specific data to control corresponding DI on/off

Address	Content	Data length
0x0203	To control DO status by the written data.	1 word

bit No.	b6~b15	b5	b4	b3	b2	b1	b0
DI	<b>0</b>	DO6	DO5	DO4	DO3	DO2	DO1

Step 4: To quit this mode by 0x0000 written at “0x0901” address.

**(9) JOG test (readable and writable)**

Step 1: Check the drive without any alarm occurrence or Servo ON activated.

Address	Content	Data length				
0x0900	<table border="1" style="display: inline-table; vertical-align: middle;"> <tr> <td>0</td> <td>z</td> <td>y</td> <td>x</td> </tr> </table> x=0 Servo OFF, x=1 Servo ON;    zy: Alarm code	0	z	y	x	1 word
0	z	y	x			

Step 2: Write 0x0003 to perform this mode.

Step 3: To set acceleration/deceleration time constant of JOG test(suitable for positioning test).

Address	Content	Data length
0x0902	Acceleration/deceleration time constant [ms] Setting range: 0~20000	1 word

Step 4: JOG speed command

Address	Content	Data length
0x0903	JOG speed command [rpm] Setting range: 0~3000	1 word

Step 5: JOG operation

Address	Content	Data length
0x0904	0: to stop motor running. 1: run the motor at forward rotation.(CCW) 2: run the motor at reverse rotation.(CW)	1 word

Step 6: To quit this mode by 0000h written at address "0901h".

**(10) Positioning test (readable and writable)**

Step 1: Check the drive without any alarm occurrence or Servo ON activated.

Address	Content	Data length				
0x0900	<table border="1" style="display: inline-table; vertical-align: middle;"> <tr> <td>0</td> <td>z</td> <td>y</td> <td>x</td> </tr> </table> x=0 Servo OFF, x=1 Servo ON;    zy: Alarm code	0	z	y	x	1 word
0	z	y	x			

Step 2: Write 0x0004 at address "0x0901" to perform this positioning test.

Step 3: To set the acceleration/deceleration time constant of positioning test.

Address	Content	Data length
0x0902	Acceleration/deceleration time constant [ms] Setting range: 0~20000	1 word

Step 4: To set speed command of positioning test.(Refer to JOG test mentioned above)

Address	Content	Data length
0x0903	JOG speed command [rpm] Setting range: 0~3000	1 word

Step 5: To set the command pulses

Address	Content	Data length
0x0905 ~ 0x0906	Command pulses are composed of these two registers. [pulse] Setting range: 0~ (2 <sup>31</sup> -1)	1 word

Step 6: Positioning test operation

Address	Content	Data length
0x0907	0: Written 0 to pause/stop motor running.(twice pause command to stop motor running) 1: Written 1 to make motor run forward rotation.(CCW) 2: Written 2 to make motor run reverse rotation.(CW)	1 word

Step 8: To quit this mode by 0x0000 written at address "0x0901".

## 9. Troubleshooting

 **CAUTION** ●When any alarm has occurred, eliminate its cause, ensure safety, then reset the alarm, and restart operation. Otherwise, injury may occur.

### 9.1. Alarm list

The drive would display alarm or warning if some faults occurred during operation. Once an alarm or a warning occurred, please remedy the fault according to the instruction mentioned in section 7.2. When the PD19 is set as □□□1, alarm codes could be represented by the ON/OFF states of DO1(CN1\_41), DO2(CN1\_42), and DO5(CN1\_45)

Alarm code	CN1			Name	Clear			
	41	42	45		Power OFF→ON	Press "SET"	RES signal	
Alarm	AL01	0	1	0	Over voltage	○		
	AL02	0	0	1	Low voltage	○	○	○
	AL03	0	1	1	Over current	○		
	AL04	0	1	0	Regenerative alarm	○	○	○
	AL05	1	0	0	Overload 1	○	○	○
	AL06	1	0	1	Over speed	○	○	○
	AL07	1	0	1	Pulse command abnormal	○	○	○
	AL08	1	0	1	Position error excessive	○	○	○
	AL09	0	0	0	Communication abnormal	○	○	○
	AL0A	0	0	0	Communication time-out	○	○	○
	AL0B	1	1	0	Encoder error 1	○		
	AL0C	1	1	0	Encoder error 2	○		
	AL0D	1	1	0	Fan error	○		
	AL0E	0	0	0	IGBT overheat	○		
	AL0F	0	0	0	Memory error	○		
	AL10	0	0	0	Overload 2	○		
	AL11	1	1	1	Motor mismatched	○		
AL20	1	1	1	Motor crash error	○			
AL21	1	1	1	Motor U,V,W lines disconnected	○			
AL22	1	1	0	Encoder communication error	○			
AL24	0	0	0	Encoder type error	○			
AL26	1	1	0	Encoder error 3	○			
AL27	1	1	0	Encoder error 4	○			



Alarm code	CN1			Name	Recovery			
	41	42	45		Power OFF→ON	Press "SET"	RES signal	
Alarm	AL28	1	1	0	Encoder overheat	○		
	AL29	1	1	0	Encoder error 5	○		
	AL2A	1	1	0	ABS encoder abnormal 1	○		
	AL2B	1	1	0	ABS encoder abnormal 2	○		
	AL2E	0	1	1	Control circuit abnormal	○		
	AL2F	0	1	1	Regenerative energy abnormal	○		
	AL30	0	1	1	Pulse output frequency excess	○	○	○
	AL31	0	1	1	Over current 2	○		
	AL32	0	1	1	Control circuit abnormal 2	○		
	AL33	0	1	1	Memory error 2	○		
Warning	AL12	-			Emergency stop	Remedy the fault		
	AL13				LSP/LSN activated			
	AL14				Software positive limit			
	AL15				Software negative limit			
	AL16				Overload early warning			
	AL17				ABS time out warning			
	AL18				Reserved			
	AL19				Pr command abnormal	Origin return		
	AL1A				Index coordinate undefined	Remedy the fault		
	AL1B				Position shifting error			
	AL61				Parameter group range excess	○	○	○
	AL2C				ABS encoder abnormal 3	Remedy the fault		
	AL2D				Encoder battery voltage low	Remedy the fault		
	AL62				Parameter number range excess	○	○	○
	AL63				Pr mode parameter range excess	○	○	○
	AL64				Pr mode parameter write error	○	○	○

Note 1: To clear the alarm, power off the servo drive and check the LED display is off, and then power on it again.

Note 2: When the alarm has occurred, ALM of DO would activate.

Note 3: When the warning has occurred, WNG of DO would activate.

## 9.2. Alarm cause and remedy

### **AL01 Over voltage**

Cause	Inspection	Remedy
Power supply voltage excess	Review the power voltage.	Use the proper power source.
Input power error (incorrect power).	Review the power supply.	Use proper power source.
Drive hardware damaged.	Use voltmeter to check if the power voltage is within rated voltage while error still occurred.	Contact agent for proper service.
Lead of built-in regenerative brake resistor or regenerative brake option is disconnected.	Check the P,D terminals connected well or not. Check built-in regenerative brake resistor or regenerative brake option is disconnected well.	Connect correctly.
Built-in regenerative brake resistor or regenerative brake option is damaged.	Check if it is burn out or damaged.	Change the built-in resistor or option.
Capacity of built-in regenerative brake resistor or regenerative brake option is insufficient.	Check if the capacity insufficient.	Add regenerative brake option or increase capacity.

### **AL02 Low voltage**

Cause	Inspection	Remedy
Input voltage of main circuit is lower than permissible value.	Review the power supply.	Use proper power source.
Capacity of power supply is insufficient.	Check if it occurred as motor torque regenerated huge.	Increase power supply capacity.
Input power error (incorrect power).	Review the power supply.	Use proper power source.

### **AL03 Over current**

Cause	Inspection	Remedy
Improper motor wirings.	Check the wirings.	Correct the wirings.
Short occurred in drive output phases U, V and W.	Check if the connection between drive and motor is short.	Correct the wirings to prevent from short-circuit or cable naked.
IGBT of servo drive faulty.	AL03 occurs if power is switched on after U,V and W are disconnected.	Contact agent for proper service.
Improper parameters setting.	Check relevant parameters which have modified.	Recover factory-set then re-define user's demand.

### **AL04 Regenerative alarm**

Cause	Inspection	Remedy
Brake transistor fault.	Set PC36 to be 0 and re-power on, if AL04 is occurred soon, it means the brake transistor broken.	Contact agent for proper service.
Built-in brake resistor or brake option is disconnected.	Check the wirings.	Correct the wirings.

### **AL05 Overload 1**

Cause	Inspection	Remedy
Operate the servo drive in heavy duty continually.	Check if mechanism load is huge.	Upgrade the capability of servo or reduce the duty.
Improper gain values setting.	Check if vibration of mechanism is occurred.	Re-operate the auto-gain tuning job to obtain the proper gain value.
Servo system is instable.	Check if acceleration/deceleration time constant is proper.	Extend these setting values.
Encoder faulty.	As motor shaft is rotated slowly with Servo OFF, the pulses feedback should vary in proportion to rotary angle. If the indication skips or returns midway, it is faulty.	Contact agent for proper service.

### **AL06 Over speed**

Cause	Inspection	Remedy
Command pulses frequency exceeded the permissible instantaneous speed frequency.	Check the frequency of command pulses whether exceeds the permissible range.	Set the command pulses frequency correctly.
Improper acceleration/deceleration time constant settings.	Check if these values are too small.	Increase acceleration/deceleration time constant.
Servo system is instable to cause overshoot.	Observe if the mechanism is with vibration.	1. Re-set proper servo gain value. 2. If gain could not be set to proper: 1) Reduce load inertia ratio; or 2) Set acceleration/deceleration time constant to proper value.

**AL07 Pulse command abnormal**

Cause	Inspection	Remedy
Pulse frequency of the command pulse is too high.	Check the frequency of command pulses whether exceeds the permissible range.	1. Set the command pulses frequency correctly. 2. After RD output signal activated, the host starts to send command.
Command device failure.	Check if the command device is normal or not.	Change the command device.

**AL08 Position error excessive**

Cause	Inspection	Remedy
Improper acceleration/deceleration time constant settings.	Check if these values are too small.	Increase acceleration/deceleration time constant.
Improper torque limit setting.	Check if PA05 setting is too small.	Increase the torque limit value.
Position loop gain value is small.	Check if PB07 setting is too small.	Increase the gain value and adjust to ensure proper operation.
Mechanism load is huge.	Check if mechanism load is huge.	Reduce load, or to use servo drive and motor provide larger output.

**AL09 Communication abnormal**

Cause	Inspection	Remedy
Improper protocol setting.	Check if the protocol is matched.	Set the protocol correctly.
Improper address setting.	Check the communication address.	Set the address correctly.
Improper data content transmitted.	Check the value accessed.	Correct the data content accessed.

**AL0A Communication time-out**

Cause	Inspection	Remedy
Cable broken or loosen.	Check if cable broken or loosen.	Replace or re-connect the cable.
Communication cycle is longer than parameter PC23 setting.	Check if PC23 setting is proper.	Set the PC23 correctly.

**AL0B Encoder error 1**

Cause	Inspection	Remedy
Wirings are in wrong sequence.	Check if wirings sequence is correct or not.	Correct the wirings.
CN2 connector is loosened or disconnected.	Check if CN2 connector is loosen or disconnected.	Re-connect CN2 connector.
Encoder faulty	Check the encoder feedback pulses continuity of motor while Servo OFF	Contact agent for proper service.

**AL0D Fan error**

Cause	Inspection	Remedy
Cooling fan stops working.	Change the fan by user or contact agent for proper service.	

**AL0E IGBT overheat**

Cause	Inspection	Remedy
Operate the drive in over-rate duty continuously.	Check if mechanism is overload or motor current is huge.	Reduce load, or to use servo drive and motor provide larger output.

**AL0F Memory error**

Cause	Inspection	Remedy
Data read-out/write-in abnormally.	To execute the parameter recovery or power on reset and check if it still null.	Contact agent for proper service.

**AL10 Overload 2**

Cause	Inspection	Remedy
Mechanical impact	Check if the moving route is proper.	1. Correct the moving route. 2. Install limit switches.
Wrong connection of servo motor.	Check the wirings.	Correct the wirings.
Mechanism vibration.	Check if mechanism is instable and humming.	1. Change response level setting. 2. Make gain adjustment manually.
Encoder faulty.	To rotate motor shaft and check the continuity of encoder feedback pulses while Servo OFF.	Contact agent for proper service.

**AL11 Motor mismatch**

Cause	Inspection	Remedy
The capacity of drive and motor are not compatible.	Check if they match for each other in capacity.	Use the proper combination.

**AL12 Emergency stop**

Cause	Inspection	Remedy
EMG signal is activated.	Check if EMG signal is applied and triggered.	Release the trigger after removal of some emergency conditions.

**AL13 LSP/LSN activated**

Cause	Inspection	Remedy
LSP activated.	Check if the limit switch is activated.	Release the activated cause of limit switch.
LSN activated.		

**AL14 Software positive limit**

Cause	Inspection	Remedy
Command pulses exceeds PF86	Check whether the PF86 is proper.	Set the proper PF86 value.

**AL15 Software negative limit**

Cause	Inspection	Remedy
Command pulses exceeds PF86	Check whether the PF86 is proper.	Set the proper PF86 value.

**AL16 Overload early warning**

Cause	Inspection	Remedy
The actual load exceeds the software protection of servo drive.	<ol style="list-style-type: none"> <li>1. Check whether overload has occurred.</li> <li>2. Check whether the PA17 setting is low.</li> </ol>	<ol style="list-style-type: none"> <li>1. Refer the AL05 remedy.</li> <li>2. Set the PA17 value higher or set a value which excess 100 to disable this early warning.</li> </ol>

**AL17 ABS time out warning**

Cause	Inspection	Remedy
Absolute position communication waiting time out.	<ol style="list-style-type: none"> <li>1. Check whether overload has occurred.</li> <li>2. Check whether the PA17 setting is low.</li> </ol>	<ol style="list-style-type: none"> <li>1. Refer the AL05 remedy.</li> <li>2. Set the PA17 value higher or set a value which excess 100 to disable this early warning.</li> </ol>

**AL19 ABS time out warning**

Cause	Inspection	Remedy
Position command counter overflow	<p>Incremental system When the motor keeps rotating in the same direction, the feedback pulse register would overflow.</p> <p>Absolute system  <ol style="list-style-type: none"> <li>1. Feedback pulse register overflow.</li> <li>2. Change electronic gear ratio without executing origin return.</li> <li>3. Execute the absolute position command when the HOME is off.</li> </ol> </p>	Execute the origin return.

**AL20 Motor crash error**

Cause	Inspection	Remedy
Motor current exceeds the PA15 setting and the duration is over PA16.	<ol style="list-style-type: none"> <li>1. Check the PA15 is valid or not.</li> <li>2. Check the PA15 whether is too low or PA16 is too soon.</li> </ol>	<ol style="list-style-type: none"> <li>1. Disable the PA15.</li> <li>2. To set the proper level of these 2 parameters according to the actual load condition.</li> </ol>

**AL21 Motor U, V, W lines disconnected**

Cause	Inspection	Remedy
Drive detects the disconnection of motor power lines.	Check the power lines of motor whether are loosen or not.	Re-connect the power lines well.

**AL22 Encoder communication error**

Cause	Inspection	Remedy
The encoder send 3 times CRC message to the servo drive.	<ol style="list-style-type: none"> <li>1. Check the grounding of motor.</li> <li>2. Check the encoder cable whether are wired together with the motor power lines.</li> </ol>	<ol style="list-style-type: none"> <li>1. Ground the motor to obtain a good immunity of noise.</li> <li>2. Separate the encoder cable from motor power lines.</li> </ol>

**AL24 Encoder type error**

Cause	Inspection	Remedy
Try to enable the absolute encoder function with an incremental type of encoder.	<ol style="list-style-type: none"> <li>1. Check the encoder whether it is absolute type or not.</li> <li>2. Check the PA28 setting.</li> </ol>	<ol style="list-style-type: none"> <li>1. Choose the proper type of encoder.</li> <li>2. If the absolute position function is not performed, set "0" value into PA28.</li> </ol>

**AL26 Encoder error 3**

Cause	Inspection	Remedy
The LED attenuation of encoder or encoder feedback pulses abnormal.	Power off the drive and power on again to check this phenomenon.	If there is still a recurrence, please contact your agent for repair service.

**AL27 Encoder error 4**

Cause	Inspection	Remedy
Encoder memory abnormal	<ol style="list-style-type: none"> <li>1. Check the grounding of motor.</li> <li>2. Check the encoder cable whether are wired together with the motor power lines.</li> <li>3. Check the shield of encoder.</li> </ol>	<ol style="list-style-type: none"> <li>1. Link the drive ground and motor ground together.</li> <li>2. Separate the encoder cable from the motor power lines.</li> <li>3. Use the encoder cable with shield cover to obtain a better noise immunity.</li> </ol>

**AL28 Encoder overheat**

Cause	Inspection	Remedy
The surrounding air temperature of encoder operation environment is higher than 95°C .	Check surrounding air temperature of encoder operation environment.	<ol style="list-style-type: none"> <li>1. To prevent the heat source nearby.</li> <li>2. To reduce the output torque.</li> <li>3. If the remedies do not work, contact your agent for service.</li> </ol>

**AL29 Encoder error 5**

Cause	Inspection	Remedy
The stroke revolutions are excess than the encoder specification.	1. Check the stroke revolutions. The revolutions limit is within -32768 ~+32767 turns.	Execute the origin return.



**AL2A ABS encoder abnormal 1**

Cause	Inspection	Remedy
The voltage of encoder battery is low.	1. Check the voltage of encoder battery whether is less than 2.45 volt.	After replacing battery, execute the origin return.
The bad contact between encoder and battery, or the battery power lines disconnected.	1. Check the encoder wirings. 2. Check the contacts between the encoder power lines and battery box.	After the wirings repairing, execute the origin return.

**AL2B ABS encoder abnormal 2**

Cause	Inspection	Remedy
The counter of encoder revolutions is abnormal.	Power off the servo drive, and then run the servo motor, check whether it is a recurrence.	If there is still a recurrence, please contact your agent for service.

**AL2C ABS encoder abnormal 3**

Cause	Inspection	Remedy
Replace the encoder batter when the power of servo drive has turned off.	Not to replace the encoder battery unless the power of servo drive is on.	Execute the origin return.
The absolute coordinate initialization has not executed when the absolute coordinate system operated.	---	Execute the origin return.

**AL2D Encoder battery voltage low**

Cause	Inspection	Remedy
The voltage of encoder battery is low.	1. Check the LED display whether AL2D message is shown. 2. Measure the battery voltage.	Please keep the power of servo drive and then replace the battery of encoder.

**AL2E Control circuit abnormal**

Cause	Inspection	Remedy
The SON signal is malfunction.	Check the SON signal whether is disturbed.	Prevent the noise interference.
Current feedback circuit is abnormal.	Power reset the servo drive, if it is a recurrence; please contact your agent for service.	

**AL2F Regenerative energy abnormal**

Cause	Inspection	Remedy
The regenerative load ratio is more than 100%.	<ol style="list-style-type: none"> <li>1. Check whether the deceleration time setting is too short.</li> <li>2. To prevent the occasion where forward rotation and reverse rotation are performed frequently.</li> </ol>	<ol style="list-style-type: none"> <li>1. Set the proper deceleration time to reduce voltage regenerated.</li> <li>2. Consult your agent to check whether the drive capacity is sufficient or not.</li> </ol>

**AL30 Pulse output frequency excess**

Cause	Inspection	Remedy
The encoder is breakdown.	Check the alarm histories whether these AL0B, AL0C, AL22, AL26, AL27 had occurred.	Follow the remedy AL0B, AL0C, AL22, AL26, and AL27.
Pulse output frequency exceeds the hardware ability.	Confirm whether the conditions occurred: <ol style="list-style-type: none"> <li>1. Motor speed is excess than PA41.</li> <li>2. <math>(\text{Motor speed}/60) * \text{PA14} &gt; 20 \times 10^6</math></li> </ol>	Set the PA41 and PA14 properly.

**AL31 Over current 2**

Cause	Inspection	Remedy
The current feedback circuit of servo drive is abnormal.	Power reset the servo drive, if it is a recurrence; please contact your agent for service.	

**AL32 Control circuit abnormal 2**

Cause	Inspection	Remedy
FPGA hardware abnormal	Power reset the servo drive, if it is a recurrence; please contact your agent for service.	

**AL33 Memory error 2**

Cause	Inspection	Remedy
The flash memory abnormal	Power reset the servo drive, if it is a recurrence; please contact your agent for service.	

**AL34 Overload 4**

Cause	Inspection	Remedy
The external load exceeds the rate of drive capacity in continuous used	Check if the reciprocating stroke is too fast	Upgrade the motor capacity or reduce the reciprocating stroke frequency
The mechanical system is unstable	Check whether the acc./dec. time setting is too fast	Increase the acc./dec. time setting

**AL1A Index coordinate undefined**

Cause	Inspection	Remedy
The origin initialization has not executed when the index coordinate operated.	1. To execute the origin return before the index coordinate is operated. 2. To activate RES to release the alarm status. 3. SON: off→on	

**AL1B Position shifting error**

Cause	Inspection	Remedy
MC_OK signal ON/OFF state changes.	After positioning completion, check whether any external force causes the final position to be shifted.	1. Activate the RES signal. 2. Press "SET" key at the alarm message screen. 3.SON: off→on

**AL1C Overload 4 early warning**

Cause	Inspection	Remedy
Overload duration exceeds the pre-warning of protection curve.	Check if the external load exceeds the rated capacity of motor.	Refer to the remedy of AL.34.

**AL61 Parameter group range excess**

Cause	Inspection	Remedy
Parameter group request exceeds A~F range.	Check the communication command whether is correct or not.	Execute any one instruction below 1. Power off the drive. 2. Press "SET" key at the alarm message screen. 3. Activate the RES signal.

**AL62 Parameter number range excess**

Cause	Inspection	Remedy
Parameter group number request exceeds the specific range.	Check the communication command whether is correct or not.	Execute any one instruction below 1. Power off the drive. 2. Press "SET" key at the alarm message screen. 3. Activate the RES signal.

**AL63 Pr mode parameter range excess**

Cause	Inspection	Remedy
Parameter command request exceeds the specific range.	Check the communication command whether is correct or not.	Execute any one instruction below 1. Power off the drive. 2. Press "SET" key at the alarm message screen. 3. Activate the RES signal.

**AL64 Pr mode parameters write error**

Cause	Inspection	Remedy
To write parameter modification when SON is activated.	Check the SON status when Pr command is going to be changed.	

## 10. Specifications

### 10.1. Drive specifications

SDE-□□□A2U		010	010	020	040	075	100	150	200	300	
SME-□□□□ (matched motor)		L005	L010	L020	L040	L075	L100	L150	L200	L300	
Motor power		50W	100W	200W	400W	750W	1KW	1.5KW	2KW	3KW	
Main circuit power	Input	Voltage/Frequency	3φ or 1φ 200~240Vac, 50/60Hz (3kW drive is suitable for only 3φ power)								
		Allowable voltage Range	3φ or 1φ 170~264Vac (3kW drive is suitable for only 3φ power)								
		Allowable frequency Range	Within ±5%								
	Output	Voltage	110V				140V				
		Current [A]	1.0	1.0	1.8	3.2	5.8	6.4	9.4	12.1	17.6
		Voltage/Frequency	0~250Hz				0~167Hz				
Control circuit power	Input	Voltage/Frequency	1φ AC200~240V 50/60Hz								
		Allowable voltage Range	1φ 170~264Vac								
		Allowable frequency Range	Within ±5%								
	Power consumption	30W									
Control mode		3φ full-wave rectification, IGBT-PWM control (SVPWM)									
Dynamic brake		Built-in(software)									
Protection		Over current, over voltage, overload, fan failure protection, output short-circuit protection, abnormal encoder protection, abnormal regeneration protection, low voltage/power interruption protection, over speed protection, error excessive									
Encoder type		2 <sup>22</sup> (4,194,304) pulses/rev, maximum 65536 revolutions									
Communication interface		RS485(ModBus protocol) ; USB									
Position control mode	Input pulse frequency		Line driver : 500Kpps(low)/4Mpps(high) ; Open collector : 200Kpps								
	Command pulse type		CCW pulse + CW pulse ; Pulse + Direction ; A phase + B phase								
	Command source		External pulse train input/Inner register								
	Command smoothing		Low-pass filter/Linear acceleration and deceleration pattern/S-pattern smoothing								
	Electronic gear ratio		Electronic gear ratio A/B-time, A: 1~4194304; B:1~4194304 1/50 < A/B < 64000								
	Position error excessive		±3 revolutions								
	Torque limit		Parameter limit or torque analog limit (0~+10Vdc/Maximum torque)								
	Feed-forward function		Parameter setting: 0~200%								

SDE-□□□A2U		010	010	020	040	075	100	150	200	300
SME-□□□□ (matched motor)		L005	L010	L020	L040	L075	L100 M100	L150 M150	L200 M200	L300 M300
Motor power		50W	100W	200W	400W	750W	1KW	1.5KW	2KW	3KW
Speed control mode	Speed control range	Speed analog command 1:2000; Parameter command 1:5000								
	Command source	Speed analog voltage input/ Parameter command								
	Command smoothing	Low-pass filter/Linear acceleration and deceleration pattern/S-pattern smoothing								
	Speed analog input	0~±10Vdc/Rated speed (Input impedance: 10~12kΩ)								
	Speed change rate (note1)	Load change: 0~100% ; maximum ±0.01%, Power source change ±10%; maximum 0.01%, Surrounding temperature 0°C~55°C; Maximum ± 0.5% (Speed analog command)								
	Torque limit	Inner limit or torque analog limit (0~+10Vdc/Maximum torque)								
	Bandwidth	Maximum 1kHz								
Torque mode	Command source	Torque analog voltage input								
	Command smoothing	Low-pass filter								
	Torque analog input	0~±10Vdc/Max torque generated(Input impedance: 10~12kΩ)								
	Speed limit	Parameter limit or speed analog limit (0~+10Vdc/Maximum speed)								
Digital input/output signal	Digital input(DI)	Servo ON, forward and reverse rotation limit switch, pulse error clearing, torque direction option, speed command option, position command option, forward and reverse rotation command, proportional control switched, torque limit switched, abnormal alarm reset, emergency stop, control mode switching, electric gear ratio options, gain switching								
	Digital output(DO)	Torque limit attain, speed limit attain, ready signal, zero speed attained, position attained, speed attained, alarm signal, home moving completed								
	Analog input	Speed analog command/limit, Torque analog command/limit,								
	Analog output	Command pulse frequency, pulse error, current command, DC bus voltage, motor speed, generated torque								
Environment	Temperature	operating	0°C~ 55°C(If it is above 45°C forced cooling would be required)							
		storage	-20~65°C(non-freezing)							
	Humidity	operating	90%RH or less (non-condensing)							
		storage	90%RH or less (non-condensing)							
	Installation site	Indoor(no direct sunlight), no corrosive gas, no oil mist or dust, no flammable gas								
	Altitude	Max.1000m (3280ft) or lower above sea level								
	Vibration	Maximum 59m/s <sup>2</sup>								
Pollution degree	2									
Cooling method(structure)		Nature cooling, (IP20)				Force cooling, (IP20)				
Weight(kg)		1.4	1.4	1.4	1.4	1.7	1.7	2.6	2.6	2.6
Approval		CE, UL								

Note 1: Speed command is the rated speed of servo motor, Speed change rate is:  
(speed without load – speed with full load)/rated speed

## 10.2. Drive dimensions

SDE-010A2U, SDE-020A2U, SDE-040A2U (100W, 200W, 400W)

unit[mm]

單位[mm]

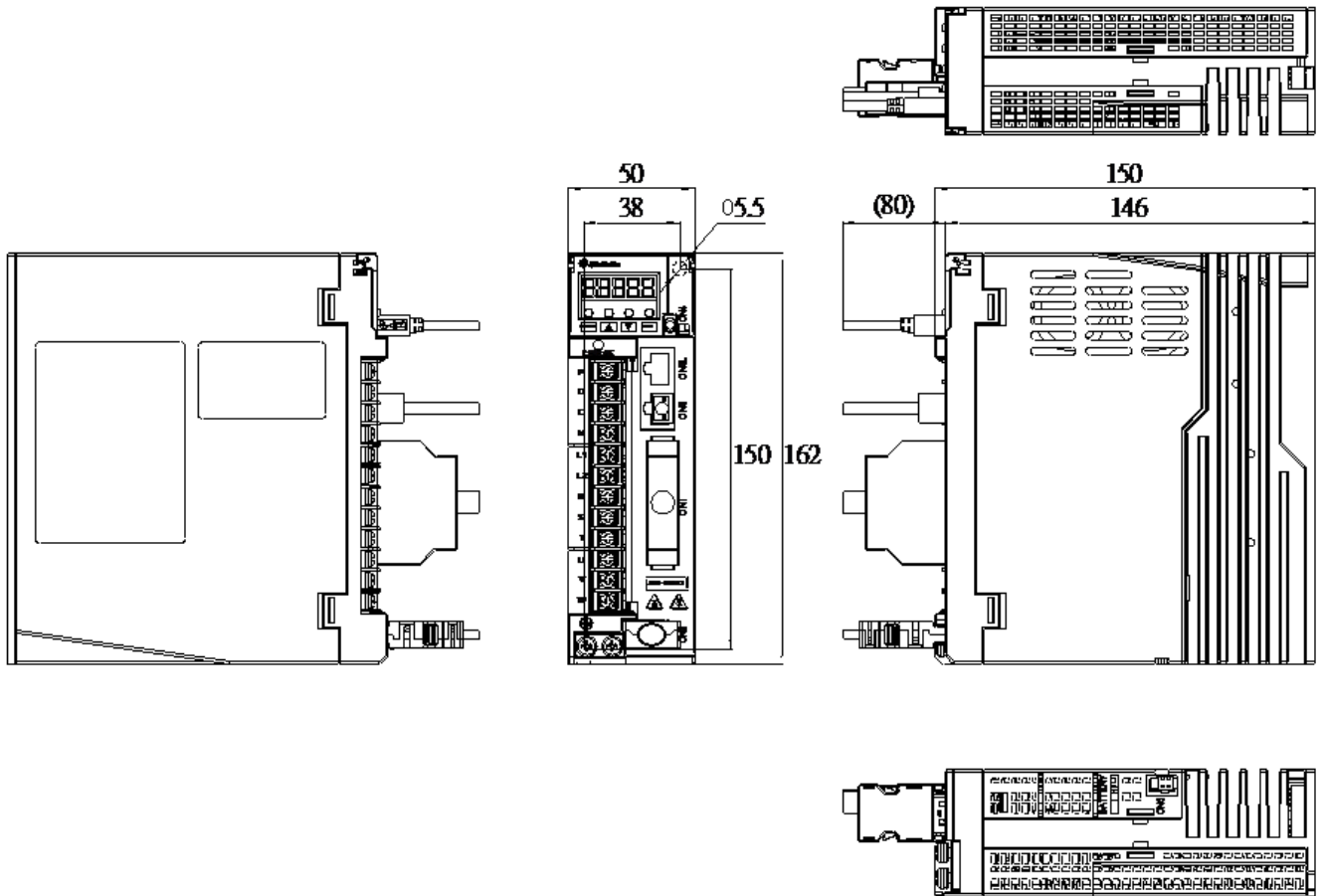

\*Dimensions of the servo drive may be revised without prior notice.

SDE-075A2U, SDE-100A2U (750W, 1KW)

unit[mm]

單位[mm]

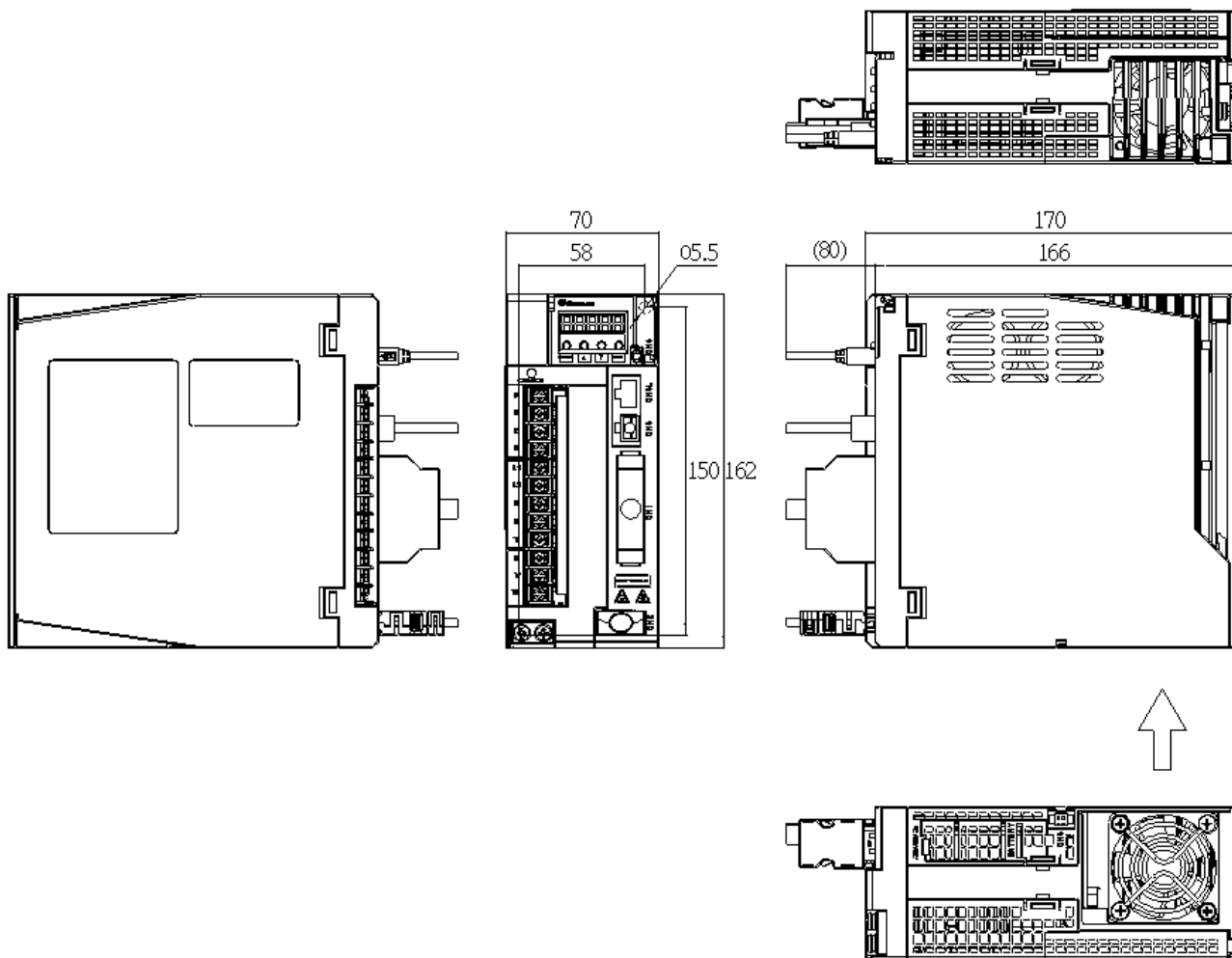

\*Dimensions of the servo drive may be revised without prior notice.



SDE-150A2U, SDE-200A2U, SDE-300A2U (1.5KW, 2KW, 3KW)

unit[mm]

單位[mm]

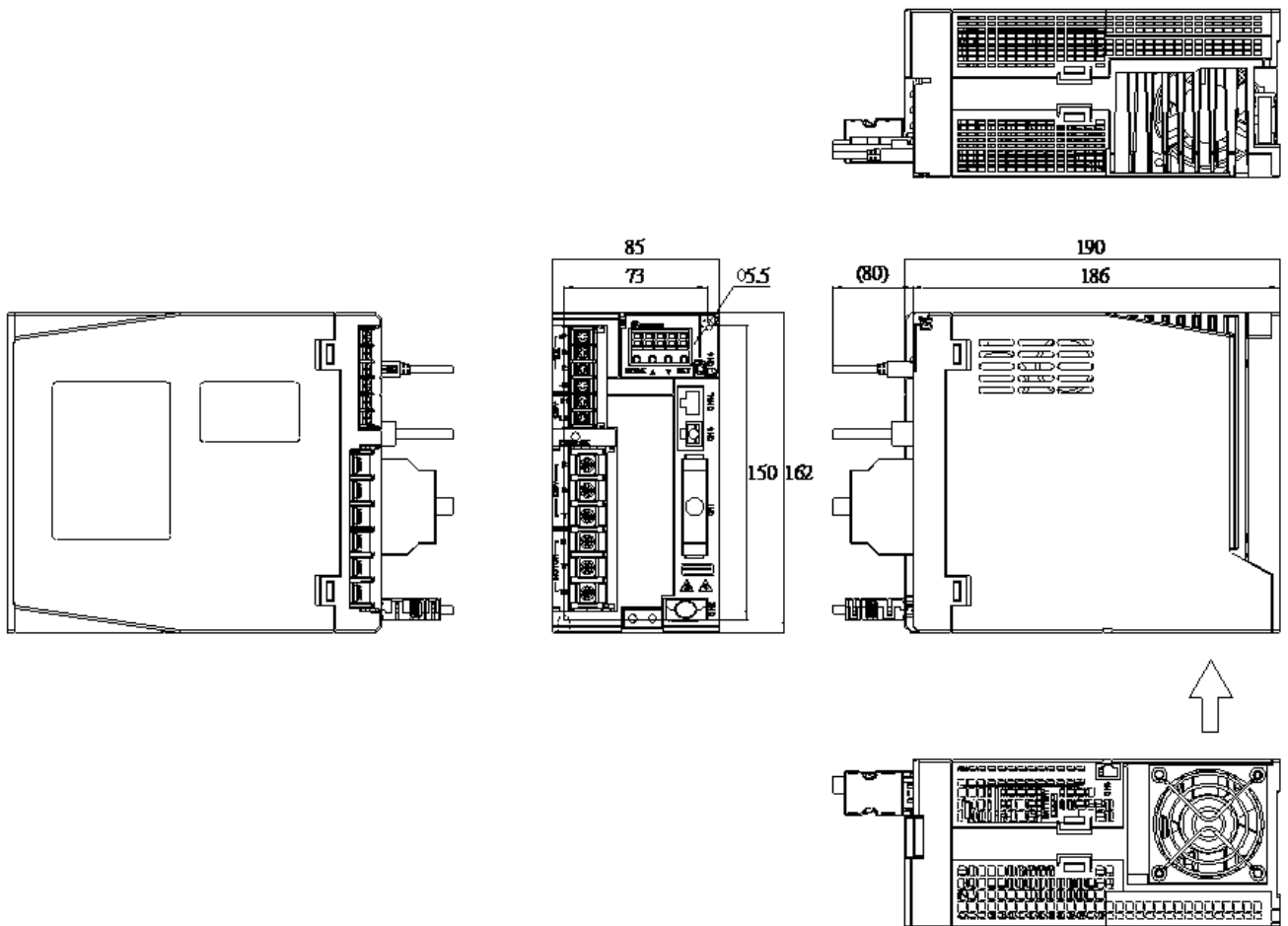

Dimensions of the servo drive may be revised without prior notice.

## 10.3. Motor specifications

### 10.3.1. Low inertia, small capacity motor specifications

SME-□□□□30XYZU	--	L005	L010	L020	L040	L075
Flange	mm	40		60		80
Rated output capacity	W	50	100	200	400	750
Rated torque (*1)	Nm	0.16	0.32	0.64	1.27	2.4
Maximum torque	Nm	0.48	0.96	1.92	3.81	7.2
Rated speed	rpm	3000				
Maximum speed	rpm	6000				
Rated current	A	0.85	0.85	1.7	2.8	5.8
Maximum current	A	2.7	2.7	5.2	9.0	18.5
Rotor inertia $J$ ( $\times 10^{-4}$ ) (*2)	kg-m <sup>2</sup>	0.0295 (0.0299)	0.0518 (0.0523)	0.161 (0.178)	0.277 (0.294)	1.07 (1.11)
Continuous running power	kw/s	8.6	19.6	25.2	58.5	53.3
Installation mental plate size	mm	250 x 250 x 6				
Isolation class	-	CE(B) & UL(A)				
Isolation impedance	-	100M $\Omega$ @ DC500V				
Isolation withstand voltage	-	60sec @ AC1500V				
Encoder resolution	-	Single turn 22bit (4,194,304 Pulse); multi turn 16bit (65,536 turns)				
Structure (*3)	-	Totally enclosed, natural cooling (IP rating: IP65)				
Vibration rank	-	V-15				
Environment	Surrounding temperature	0 °C to 40 °C (non-freezing) / storage: -15 °C to 70 °C (non-freezing)				
	Surrounding humidity	80 %RH maximum (non-condensing) / storage: 90 %RH maximum (non-condensing)				
	Altitude	1000 m or less above sea level				
	Environment condition	Indoors (no direct sunlight); no corrosive gas, inflammable gas, oil mist or dust				
	Vibration resistance	X/Y: 5G				
Shaft (*5)	Fd	mm	20	25	35	
	Radial Fr	N	68.6	245	392	
	Axial Fa	N	39.2	98	147	
Electromagnetic brake (*4)	Input voltage	V	DC 24V $\pm$ 10%			
	Brake torque	Nm	0.3	1.3	2.4	
	Power consumption	W	6.3	7.9	8.6	
	Current consumption	A	0.24	0.32	0.35	
	Impedance at 20°C	$\Omega$	92.4	75.4	67	
	Release time	ms	20	30	50	
	Bind time	ms	20	20	20	
Weight (*2)	Kg	0.33 (0.55)	0.45 (0.67)	0.85 (1.23)	1.23 (1.59)	2.24 (2.87)

Note1: In a vertical lift or cyclic to and fro application, it is recommended that the load torque of machine be kept under 70% of servo motor rated torque.

Note2: ( ) inside value indicates the inertia or weight of servo with electromagnetic brake.

Note3: The shaft-through portion and cable connectors are excluded.

Note4: The electromagnetic brake of motor cannot be used as a brake that stops a running machinery.

Note5: Refer to the diagram below for the permissible load for the shaft.

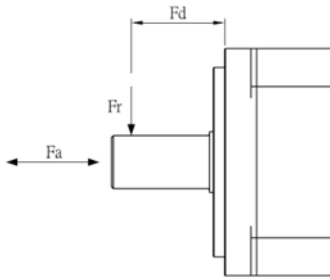

### 10.3.2. Medium capacity, low inertia motor specifications

SME-L□□□20XYZU		--	100	150	200	300
Flange	mm	130				
Rated output capacity	W	1000	1500	2000	3000	
Rated torque (*1)	Nm	4.78	7.16	9.55	14.3	
Maximum torque	Nm	14.4	21.6	28.5	43.0	
Rated speed	rpm	2000				
Maximum speed	rpm	3500				
Rated current	A	5.8	8.5	11	16	
Maximum current	A	17.4	25.5	33	48	
Rotor inertia $J$ ( $\times 10^{-4}$ ) (*2)	kg-m <sup>2</sup>	6.1 (8.0)	8.8 (10.7)	11.5 (13.5)	16.7 (18.7)	
Continuous running power	kw/s	37.6	58.3	79.3	122.9	
Installation mental plate size	mm	300 x 300 x 12				
Isolation class	-	CE(F)/ CE(B) + UL(A)				
Isolation impedance	-	100M $\Omega$ @ DC500V				
Isolation withstand voltage	-	60sec @ AC1500V				
Encoder resolution	-	Single turn: 2 <sup>22</sup> (4,194,304) pulses/rev; multi turn 2 <sup>16</sup> (65,536) turns				
Structure (*3)	-	Totally enclosed, natural cooling (IP rating: IP65)				
Vibration rank	-	V-15				
Environment	Surrounding temperature	-	0 °C to 40 °C / storage: -15 °C to 70 °C, non-freezing			
	Surrounding humidity	-	80 %RH maximum / storage: 90 %RH maximum, non-condensing			
	Altitude	-	1000 m or less above sea level			
	Environment condition	-	Indoors no direct sunlight; no corrosive gas, inflammable gas, oil mist or dust			
	Vibration resistance	-	X/Y: 2.5G			
Permissible load for the shaft (*5)	Fd	mm	50			
	Radial Fr	N	490			
	Axial Fa	N	196			
Electromagnetic brake (*4)	Input voltage	V	DC 24V $\pm$ 10%			
	Brake torque	Nm	8.5	8.5	8.5	15
	Power consumption	W	19.3	19.3	19.3	19.3
	Current consumption	A	0.8	0.8	0.8	0.8
	Impedance at 20°C	$\Omega$	29.8	29.8	29.8	29.8
	Release time	ms	40	40	40	40
	Bind time	ms	25	25	25	25
Weight (*6)	Kg	5.2/5.6 (7.0/7.4)	6.5/6.9 (8.3/8.7)	7.7/8.1 (9.5/9.9)	10.2/10.6 (12.0/12.4)	

### 10.3.3. Medium capacity, medium inertia motor specifications

SME-M□□□20XYZU		--	100	150	200	300
Flange	mm		130		176	
Rated output capacity	W		1000	1500	2000	3000
Rated torque (*1)	Nm		4.78	7.16	9.55	14.3
Maximum torque	Nm		14.4	21.6	28.5	43.0
Rated speed	rpm		2000			
Maximum speed	rpm		3500			
Rated current	A		5.8	8.5	11	16
Maximum current	A		17.4	25.5	33	48
Rotor inertia $J$ ( $\times 10^{-4}$ ) (*2)	kg-m <sup>2</sup>		10.3 (12.2)	15.0 (17.0)	32.1 (42.4)	61.2 (71.6)
Continuous running power	kw/s		22.1	34.2	28.4	33.5
Installation mental plate size	mm		300 x 300 x 12		400 x 400 x 20	
Isolation class	-		CE(F)/ CE(B) + UL(A)			
Isolation impedance	-		100M $\Omega$ @ DC500V			
Isolation withstand voltage	-		60sec @ AC1500V			
Encoder resolution	-		Single turn: 2 <sup>22</sup> (4,194,304) pulses/rev; multi turn 2 <sup>16</sup> (65,536) turns			
Structure (*3)	-		Totally enclosed, natural cooling (IP rating: IP65)			
Vibration rank	-		V-15			
Environment	Surrounding temperature	-	0 °C to 40 °C / storage: -15 °C to 70 °C, non-freezing			
	Surrounding humidity	-	80 %RH maximum / storage: 90 %RH maximum, non-condensing			
	Altitude	-	1000 m or less above sea level			
	Environment condition	-	Indoors no direct sunlight; no corrosive gas, inflammable gas, oil mist or dust			
	Vibration resistance	-	X/Y: 2.5G			
Permissible load for the shaft (*5)	Fd	mm	50	50	70	70
	Radial Fr	N	490	490	980	980
	Axial Fa	N	196	196	392	392
Electromagnetic brake (*4)	Input voltage	V	DC 24V $\pm$ 10%			
	Brake torque	Nm	8.5	8.5	45	45
	Power consumption	W	19.3	19.3	34	34
	Current consumption	A	0.8	0.8	1.41	1.41
	Impedance at 20°C	$\Omega$	29.8	29.8	17	17
	Release time	ms	40	40	110	110
	Bind time	ms	25	25	30	30
Weight (*6)	Kg		5.6/5.8 (7.4/7.6)	6.9/7.2 (8.7/9.0)	10.5/11.0 (15.8/16.3)	15.3/15.8 (20.6/21.1)

Note1: In a vertical lift or cyclic to and fro application, it is recommended that the load torque of machine be kept under 70% of servo motor rated torque.

Note2: ( ) inside value indicates the inertia of servo with electromagnetic brake.

Note3: The shaft-through portion and cable connectors are excluded.

Note4: The electromagnetic brake of motor cannot be used as a brake that stops a running machinery.

Note5: Refer to the diagram below for the permissible load for the shaft.

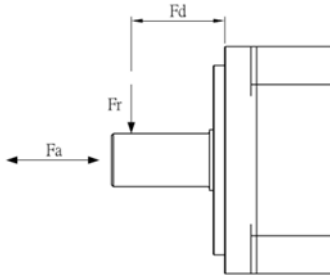

Note6: A/B: A is the motor weight of CE approval. B is the motor weight of (CE+UL) approval.

(C/D) : C is the (motor+ electromagnetic brake) weight of CE approval.

D is the (motor+ electromagnetic brake) weight of (CE+UL) approval.

## 10.4. Motor dimensions

### 10.4.1. Dimensions of motors (3000rpm rated speed)

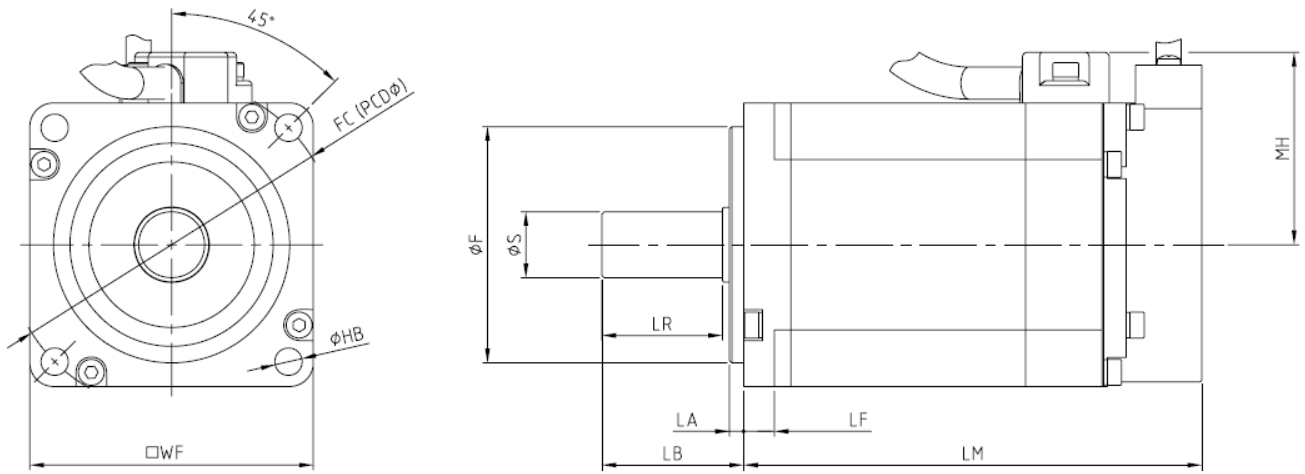

SME- L□□□30XYZU	Items dimension (mm)										
	WF	$\phi S$	$\phi F$	LA	LB	LF	LR	MH	LM(*)	FC	HB
005	40	$\phi 8 \begin{smallmatrix} 0 \\ -0.009 \end{smallmatrix}$	$\phi 30 \begin{smallmatrix} 0 \\ -0.03 \end{smallmatrix}$	2.5	25	5	21.5	31	64.5 (99.2)	46	2- $\phi 4.5$
010									80.0 (114.7)		
020	60	$\phi 14 \begin{smallmatrix} 0 \\ -0.011 \end{smallmatrix}$	$\phi 50 \begin{smallmatrix} 0 \\ -0.03 \end{smallmatrix}$	3	30	7	26	41	77.0 (112)	70	4- $\phi 5.8$
040									97.0 (132)		
L075	80	$\phi 19 \begin{smallmatrix} 0 \\ -0.013 \end{smallmatrix}$	$\phi 70 \begin{smallmatrix} 0 \\ -0.03 \end{smallmatrix}$	3	40	8	35.5	51	102.0 (149)	90	4- $\phi 6.6$

Note: ( ) inside value indicates the length of servo with electromagnetic brake.

10.4.2. Dimensions of motors (2000rpm rated speed)

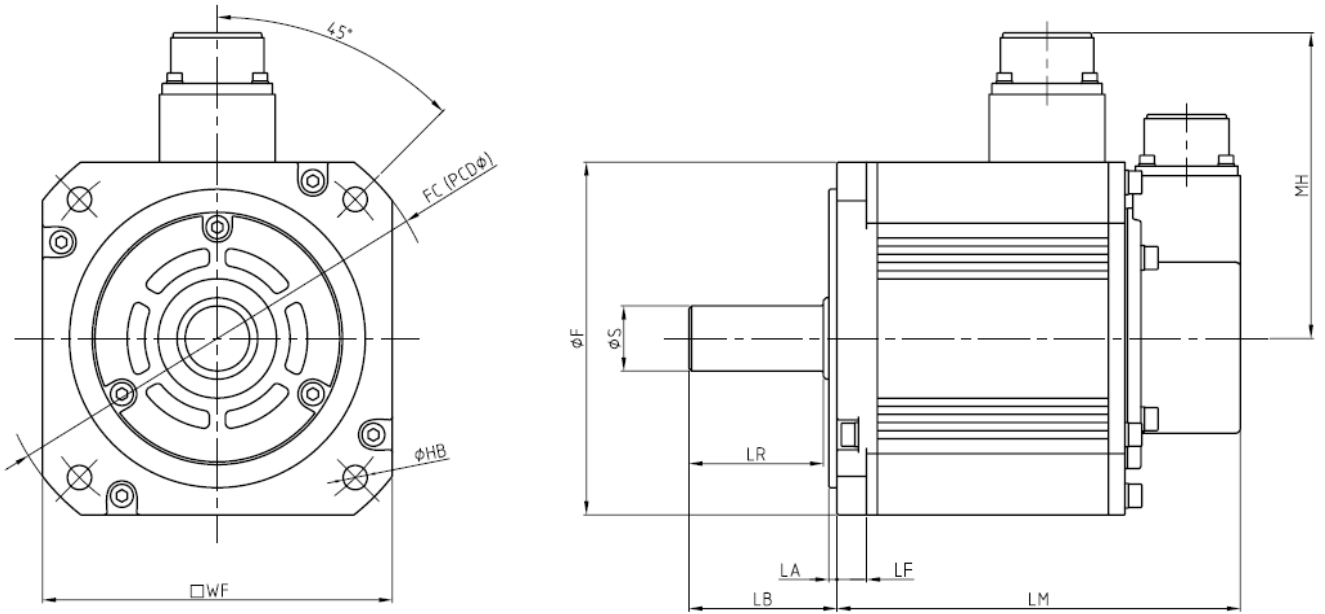

SME- □□□□20XYZU	Items dimension (mm)										
	WF	φS	φF	LA	LB	LF	LR	MH	LM(*)	FC	HB
L100	130	$\varphi 24 \begin{smallmatrix} 0 \\ -0.013 \end{smallmatrix}$	$\varphi 110 \begin{smallmatrix} 0 \\ -0.035 \end{smallmatrix}$	3	55	11	50	113	127 (161)	145	4-φ9.0
L150									141.5 (175.5)		
L200									156 (190)		
L300									185 (219)		
M100	130	$\varphi 24 \begin{smallmatrix} 0 \\ -0.013 \end{smallmatrix}$	$\varphi 110 \begin{smallmatrix} 0 \\ -0.035 \end{smallmatrix}$	3	55	11	50	113	127 (161)	145	4-φ9.0
M150									141.5 (175.5)		
M200	176	$\varphi 35 \begin{smallmatrix} 0 \\ -0.016 \end{smallmatrix}$	$\varphi 114.3 \begin{smallmatrix} 0 \\ -0.025 \end{smallmatrix}$	3	78	18.5	74	139	139 (189)	200	4-φ13.5
M300									169 (219)		

Note: ( ) inside value indicates the length of servo with electromagnetic brake.



### 10.4.3. Motor shaft end specification

(1) D-cut shaft (\*1): SME-L010, SME-L020

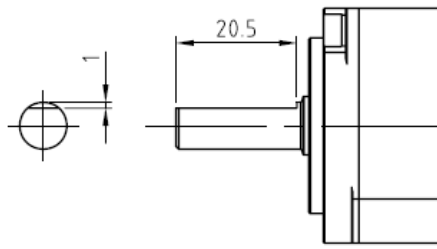

Notes1: These special shaft end motors are not suitable for frequent start/stop applications.

(2) Key shaft (\*2): SME-L020, SME-L040, and SME-L075

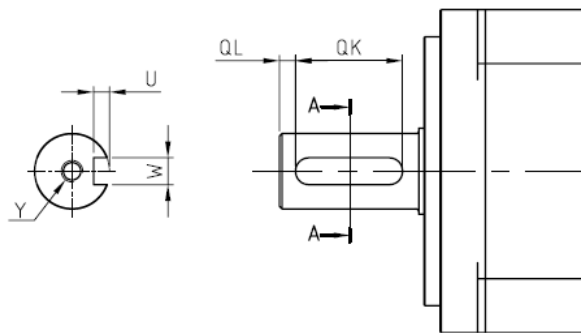

SME- □□□□ABXYZU (*3)	Items dimension (mm)				
	QL	QK	W	U	Y
L020, L040	3	20	$5 \begin{smallmatrix} 0 \\ -0.03 \end{smallmatrix}$	3	Screw: M4 Depth: 15
L075	5	25	$6 \begin{smallmatrix} 0 \\ -0.03 \end{smallmatrix}$	3.5	Screw: M5 Depth: 20
L100, L150, L200, L300 M100, M150	5	35	$8 \begin{smallmatrix} 0 \\ -0.036 \end{smallmatrix}$	4	Screw: M8 Depth: 20
M200, M300	5	55	$10 \begin{smallmatrix} 0 \\ -0.036 \end{smallmatrix}$	5	Screw: M8 Depth: 20

Notes2: A key with 2 round ends is attached.

Notes3: AB code means the rated speed of servo motor. AB is “20” or “30”.

## 10.5. Motor characteristic

### T-N curve / S-T curve

Once the applied voltage of motor is insufficient, the torque generated will reduce.

#### 【SME-L005】

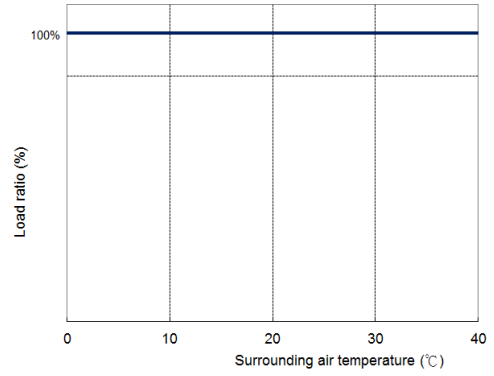

#### 【SME-L010】

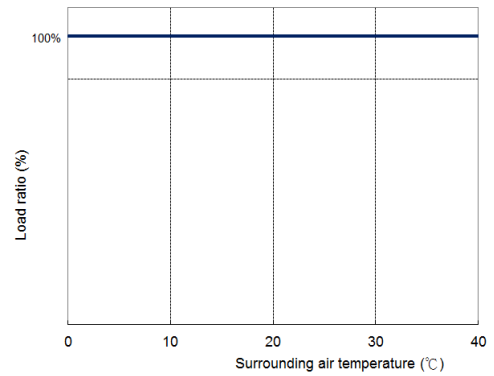

#### 【SME-L020】

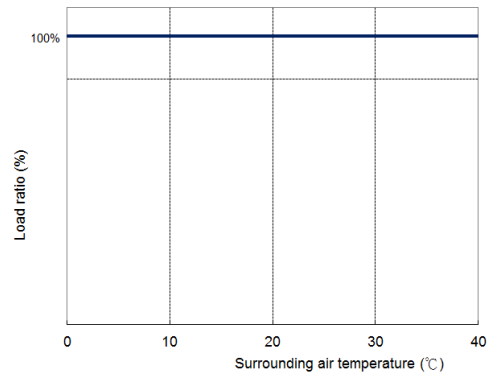
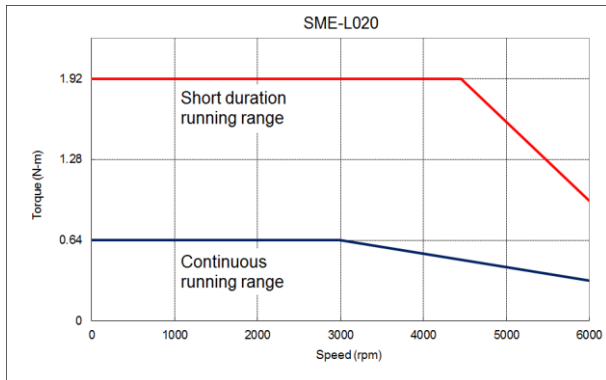

**【SME-L040】**

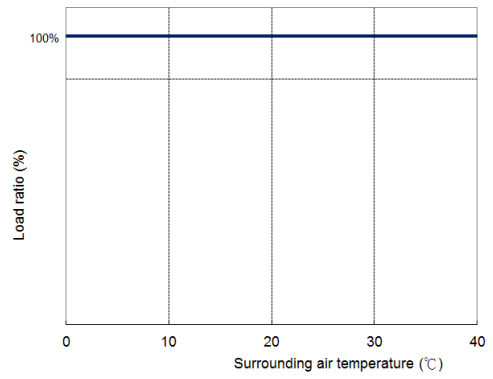
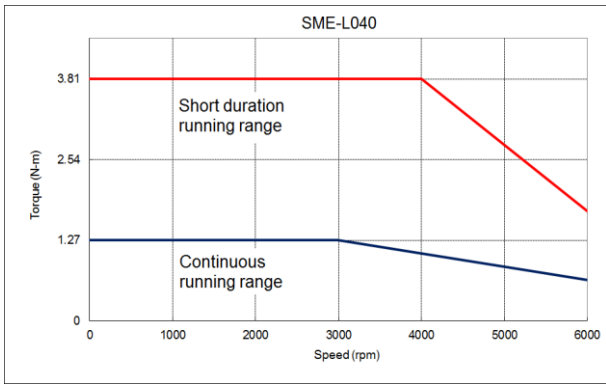

**【SME-L075】**

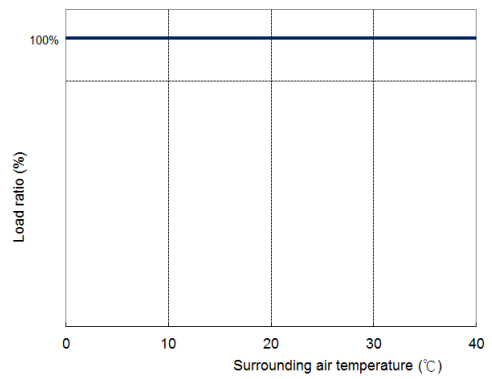
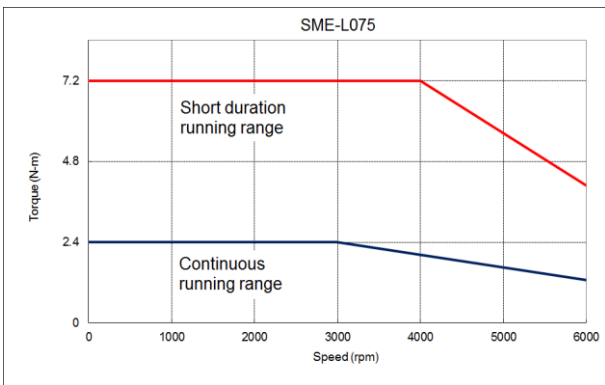

**【SME-L100】**

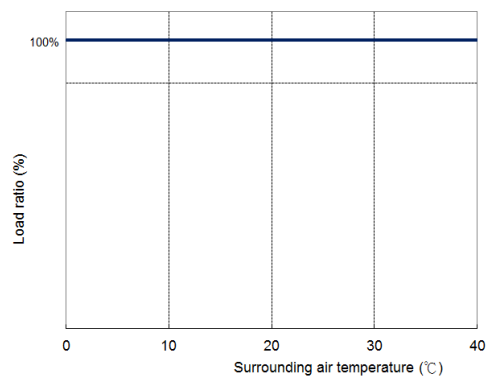
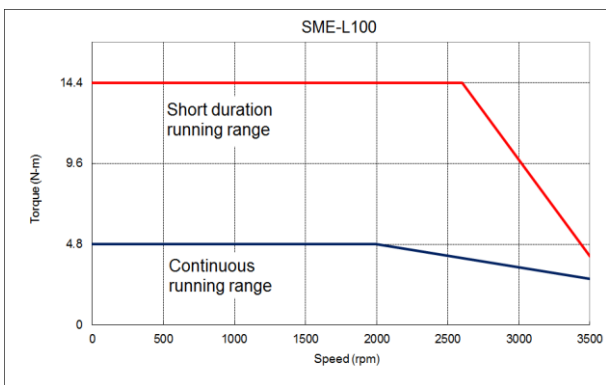

**【SME-L150】**

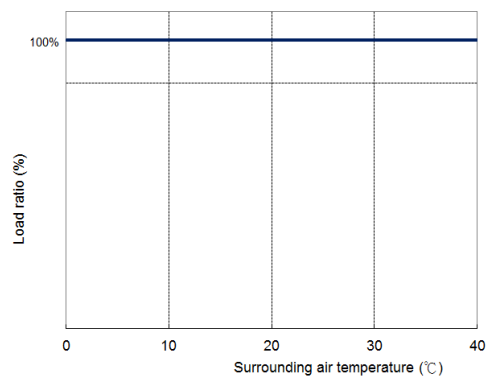
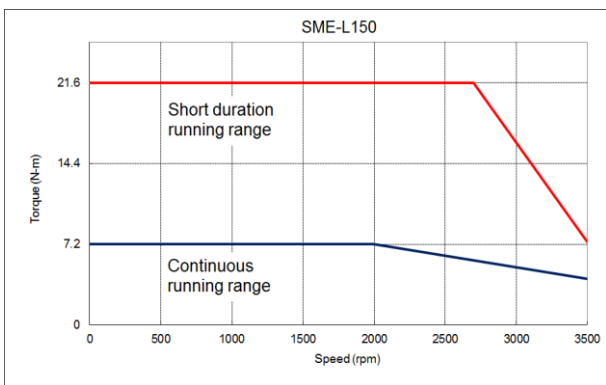

**【SME-L200】**

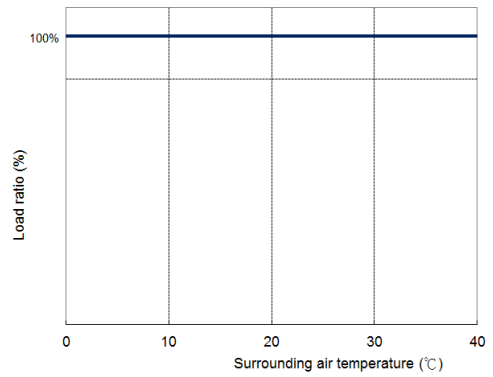
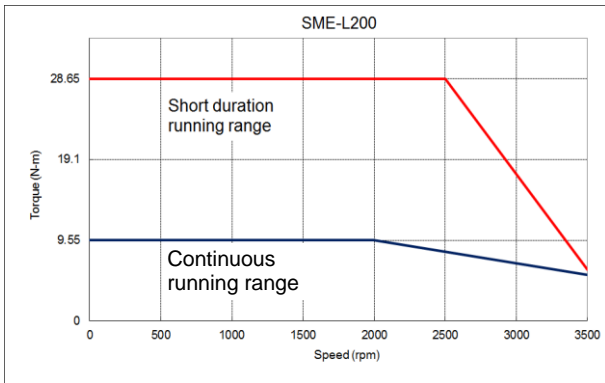

**【SME-L300】**

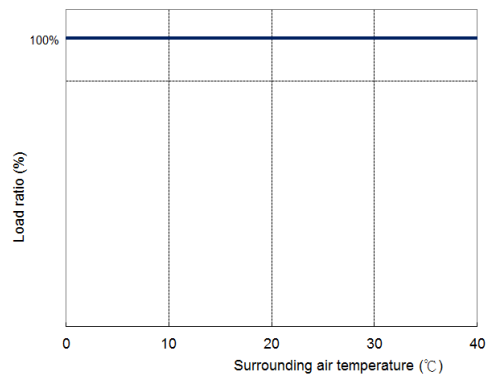
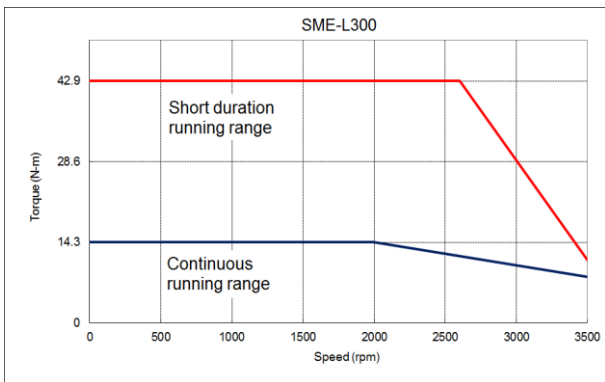

**【SME-M100】**

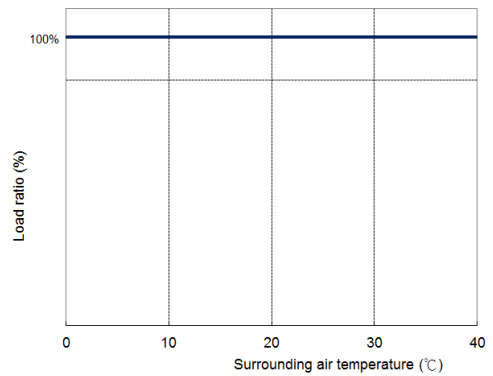
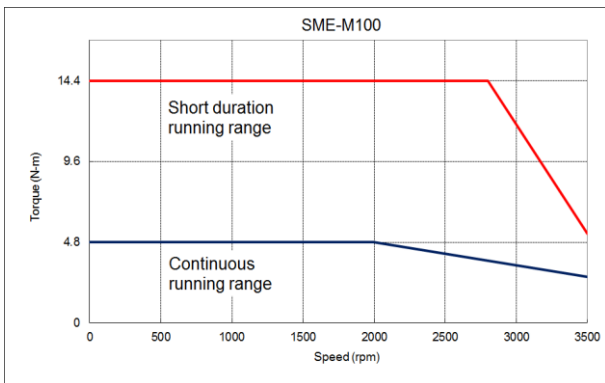

**【SME-M150】**

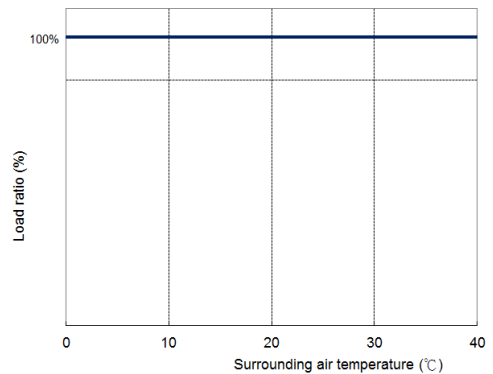
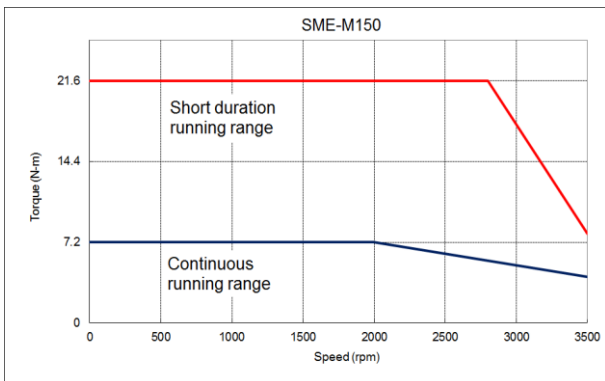

**【SME-M200】**

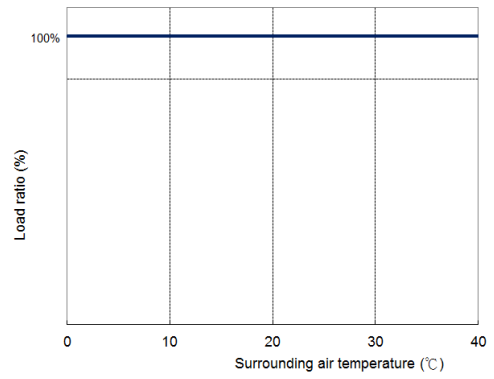
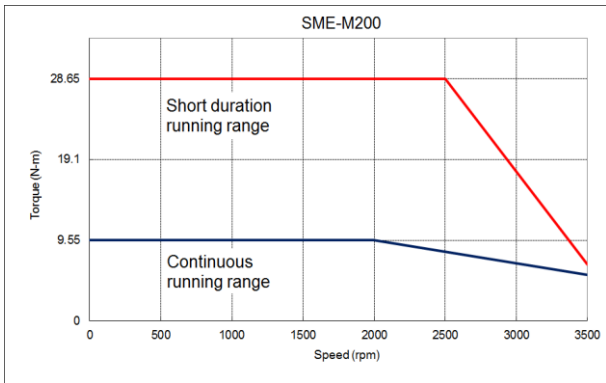

**【SME-M300】**

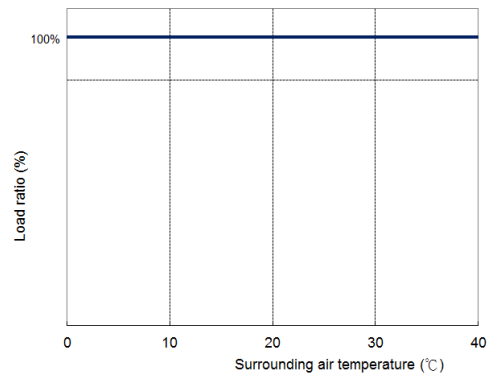
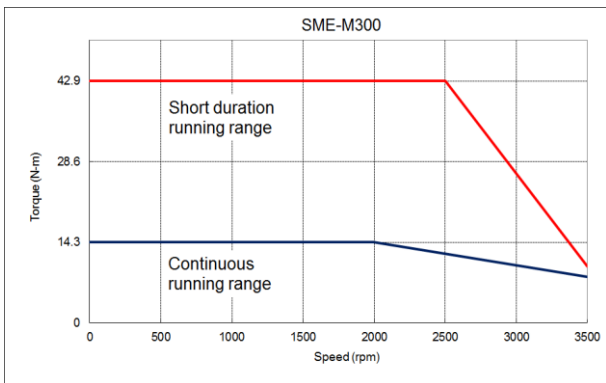

NOTE: These characteristic plots above are measured in case of 3φ 200~240V power supplied.

## 10.6. Overload protection

Overload protection is to prevent motor from damage during instantaneous over rated operation. Some cases are described as follows.

- (1) Load to motor inertia ratio is too large.
- (2) During acceleration or deceleration process, the time constant is set too small.
- (3) The time of high torque operation than rated torque is too long.
- (4) Mechanism vibration occurred due to improper gain is ignored but the motor is still performed.
- (5) Wrong connection between drive and motor, or the encoder is faulty.

If case mentioned above met, the permissible operating time is plotted below.

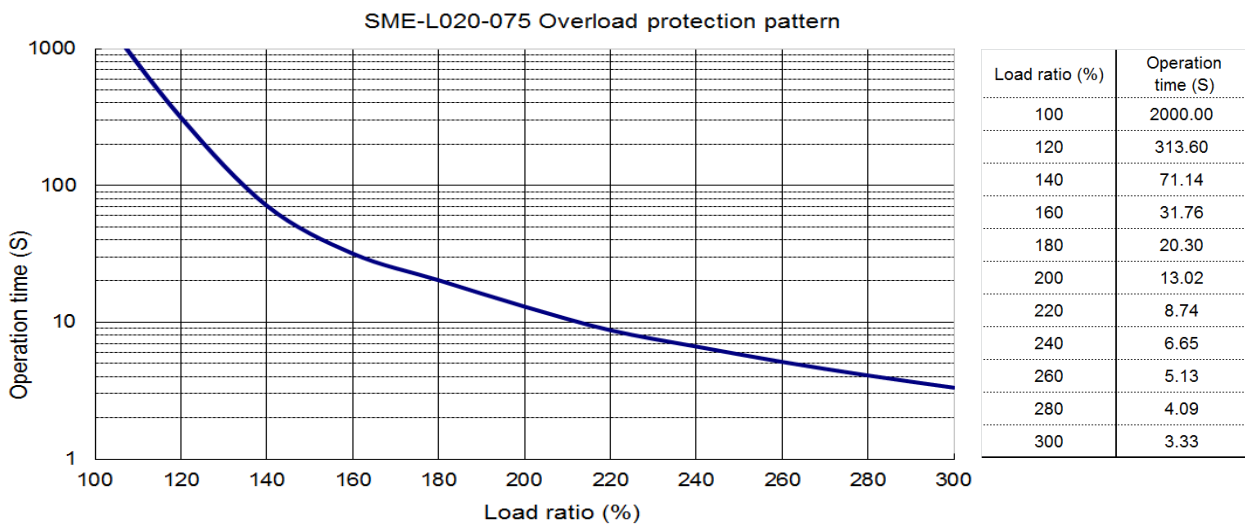
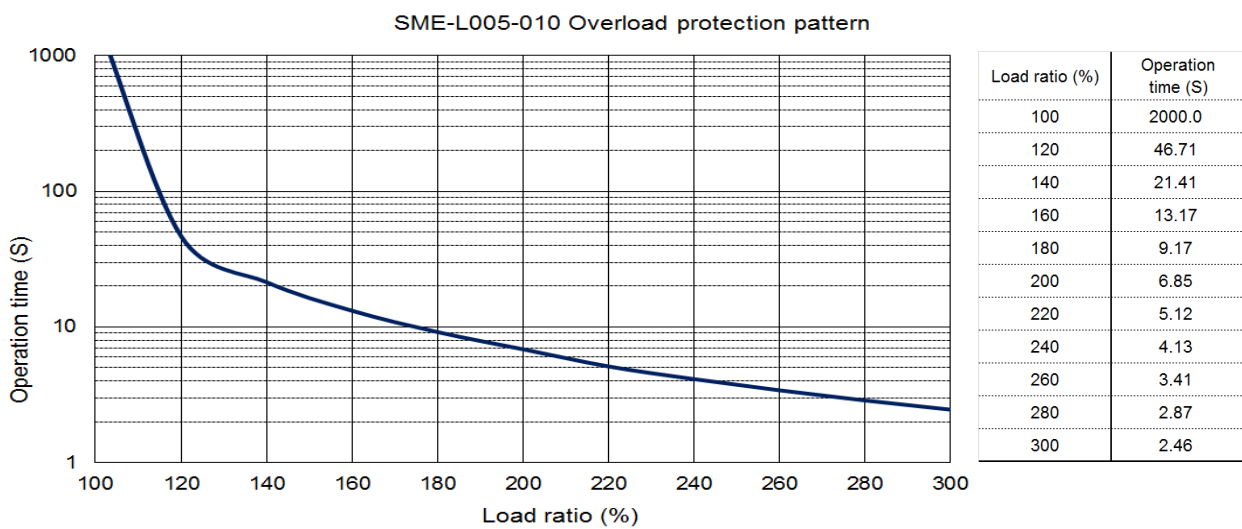

SME-100-150 Overload protection pattern

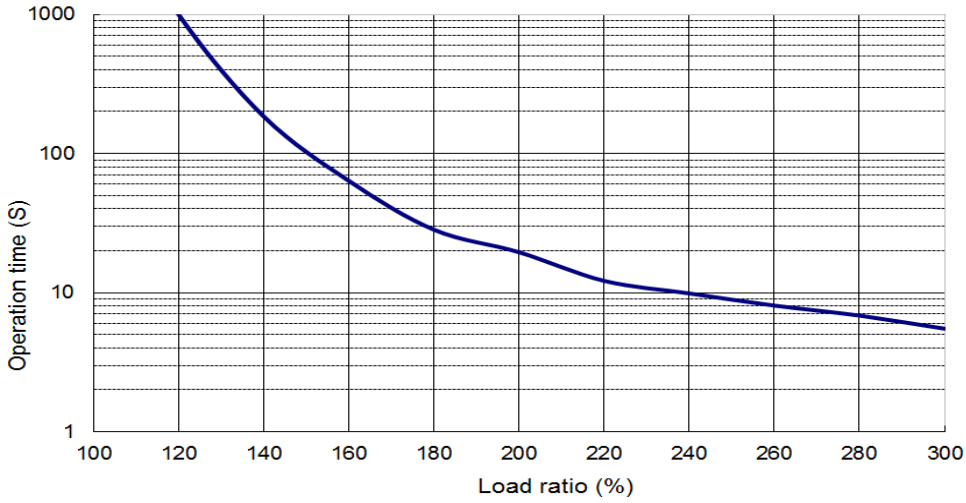

Load ratio (%)	Operation time (S)
100	10000.00
120	1000.00
140	185.15
160	63.70
180	28.35
200	19.53
220	12.16
240	9.88
260	8.08
280	6.84
300	5.51

SME-200-300 Overload protection pattern

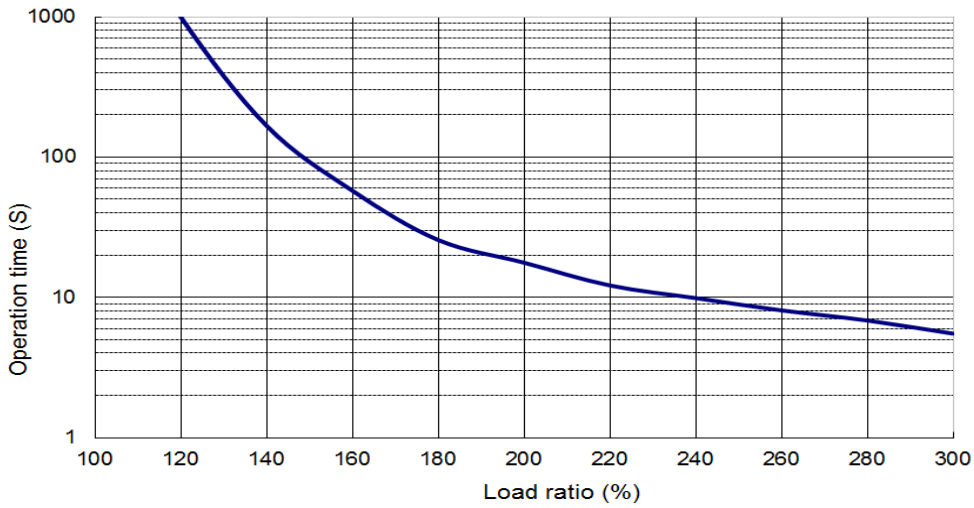

Load ratio (%)	Operation time (S)
100	10000.00
120	1000.00
140	185.15
160	63.70
180	28.35
200	19.53
220	12.16
240	9.88
260	8.08
280	6.84
300	5.51

## 11. Compliance with global standards

### 11.1. About safety

This section explains safety of users and machine operators. Please read the section carefully before installing this device.



- ◆ Before wiring or inspection, switch power off and wait for more than 20 minutes. Then, confirm if the power indicator is off or the voltage is safe with voltage meter. Otherwise, you may get an electric shock.

### 11.2. Professional engineer

Only professional engineers should mount SDE servo drives. Here, professional engineers are persons who meet the conditions below.

- (1) Persons who took a proper engineering training or persons who are engaged in electrical equipment.
- (2) Persons who have read and well understood with this manual.

### 11.3. Standard compliance

#### (1) Safety

SDE servo drives comply with the following safety standards.

*IEC/EN 61800-5-1*

#### (2) EU compliance

SDE servo drives comply with *EMC directive (2014/30/EU)* and *Low-voltage directive (2014/35/EU)*.

#### (3) USA/Canada compliance

SDE servo drives are designed in compliance with *UL 508C* and *CSA C22.2 No.274-13*.

##### (a) Installation

The minimum cabinet size is 200% of each SDE servo drive's volume. Also, use the proper cabinet which the surrounding air temperature is  $t$  at 55 °C or less. Metal cabinet is recommended to install the servo drives. For connection, use only copper wires.

##### (b) Overload protection characteristics

SDE servo drives have software motor overload protective function. It is set on the basis 125% rated current of servo drive.

##### (c) Motor over-temperature protection

Inside the motors, there is no temperature sensor. SDE series do not provide this protection.

##### (d) Capacitor discharge

It takes 20 minutes for capacitor discharging. Do not touch the unit and terminals immediately after power off.



(f) Branch circuit protection

For installation in United States, branch circuit protection must be provided, in accordance with the National Electrical Code and any applicable local codes.

For installation in Canada, branch circuit protection must be provided, in accordance with the Canada Electrical Code and any applicable provincial codes.

(4) For used in Canada only:

TRANSIENT SURGE SUPPRESSION SHALL BE INSTALLED ON THE LINE SIDE OF THIS EQUIPMENT AND SHALL BE RATED 240 V (PHASE TO GROUND), 240 V (PHASE TO PHASE), SUITABLE FOR OVERVOLTAGE CATEGORY III, AND SHALL PROVIDE PROTECTION FOR A RATED IMPULSE WITHSTAND VOLTAGE PEAK OF 4 KV, or equivalent.

## 11.4. Correct use

Use these devices within specifications (voltage, temperature, etc. Refer to section 10.1 for details.).

(1) Power wiring: For UL/CSA specification, use only copper wires rated at 75 °C for wiring.

Drive	Wire: AWG (mm <sup>2</sup> )			
	R, S, T	L1, L2	U, V, W, PE	P, D, C, N
SDE – 010A2U	AWG14 (2)	AWG14 (2)	AWG14 (2)	AWG14 (2)
SDE – 020A2U				
SDE – 040A2U				
SDE – 075A2U				
SDE – 100A2U				
SDE – 150A2U	AWG12 (3.5)		AWG12 (3.5)	
SDE – 200A2U				
SDE – 300A2U				

(2) Terminal block fixed torque: The crimping terminals must be suitable for UL specification, be with insulating tube to prevent contact directly.

Drive	Recommended Torque: in-lbs (Nt-m)			
	R, S, T	U, V, W,	L1, L2, P, D, C, N	PE
SDE – 010A2U			7.1~10.5 (0.8~1.2)	12 (1,4)
SDE – 020A2U				
SDE – 040A2U				
SDE – 075A2U				
SDE – 100A2U				
SDE – 150A2U	12 (1,4)		7.1~10.5 (0.8~1.2)	
SDE – 200A2U				
SDE – 300A2U				

(3) Selection example of MCCB:

Drive	UL Listed Current Limiting Circuit Breaker Rating	Selection example
SDE – 010A2U	240V, 5A	NF50-SVFU-5A
SDE – 020A2U		
SDE – 040A2U	240V, 10A	NF50-SVFU-10A
SDE – 075A2U	240V, 15A	NF50-SVFU-15A
SDE – 100A2U		
SDE – 150A2U	240V, 30A	NF50-SVFU-30A
SDE – 200A2U		
SDE – 300A2U		

(4) Wiring example with peripheral equipment:

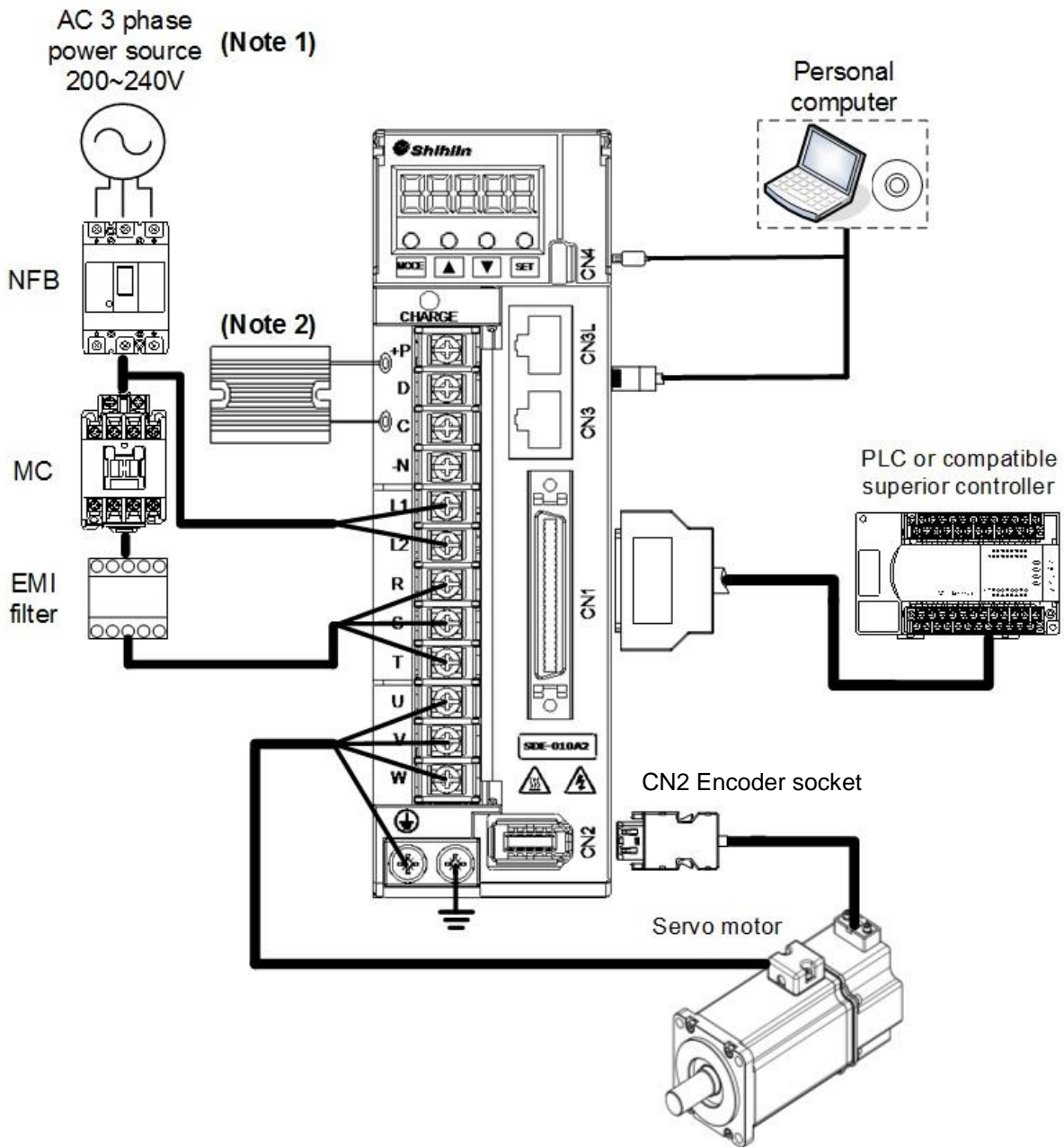

## 11.5. Inspection and maintenance

### 11.5.1. Basic inspection

It is recommended for users to inspect the following items periodically.

- (1) Inspect for loosen screws of the drive, terminals and the connection to mechanical system. Tighten any loosen screws carefully.
- (2) Check servo motor bearings, brake section, etc. for unusual noise.
- (3) Avoid any naked wires or damaged, broken wires applied for the servo motor.
- (4) Check that all wiring terminals are correctly insulated.
- (5) Check for dust accumulation on the servo drives.
- (6) Check the servo motor shaft and coupling for connection

### 11.5.2. Maintenance

Users should not disassemble the servo drive or motor as maintenance performing.

- (1) Periodically clean the surface of servo drive and motor.
- (2) Operate the servo drive and motor within the specified environmental condition range.
- (3) Clean off any dust and dirt that accumulated on the ventilation holes of servo drive.

### 11.5.3. Life of consumable components

Some components inside servo drive are consumable and must be replaced periodically. The life of consumable components is varied, which depend on operating methods and environmental conditions.

For parts replacement, please contact your sales. The lives of particular components are listed below.

Component	Life guideline	Description
Relay	100,000 times	The power supply capacity of relay decides the relay's lives. The accumulated switch times are 100,000 times.
Cooling fan	10.000 ~30.000 Hrs.	The cooling fan bearings reach the end of their life in 10,000 to 30,000 hours. It should be replaced if noise is found during inspection.
Aluminum capacitor	10 years	Affected by ripple currents and deteriorates in characteristic. Its life greatly depends on surrounding air temperature and operating conditions. The capacitor will reach the end of its life in 10 years of continuous operation in normal air-conditioned environment.

## 12. Appendix

### 12.1. Options

#### Encoder connectors

Parts number: SDH-ENCNL (100W, 200W, 400W, 750W motors)

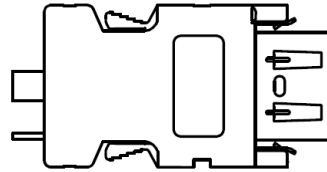
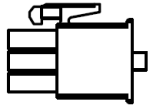

Parts number: SDH-ENCNM (1KW, 1.5KW, 2KW, 3KW motors)

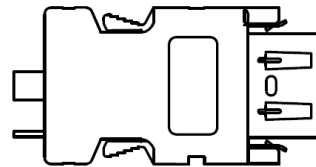
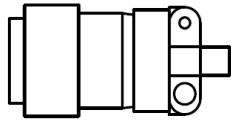

#### Encoder cable

Parts number: SDH-ENL-□M-L/H (100W, 200W, 400W, 750W motors)

□=2,5, 10 (m)

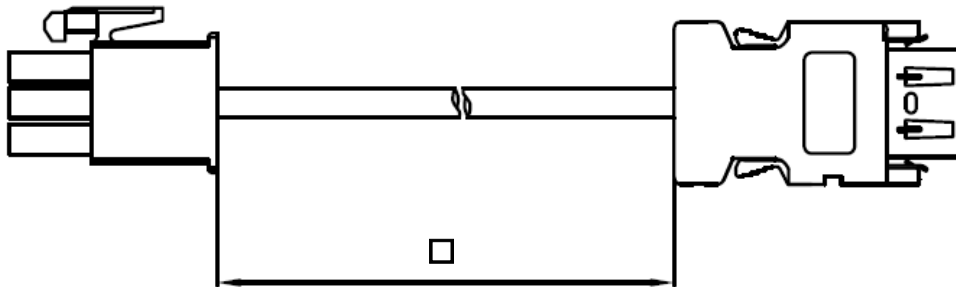

Parts number: SDH-ENM-□M-L/H (1KW, 1.5KW, 2KW, 3KW motors)

□=2,5, 10 (m)

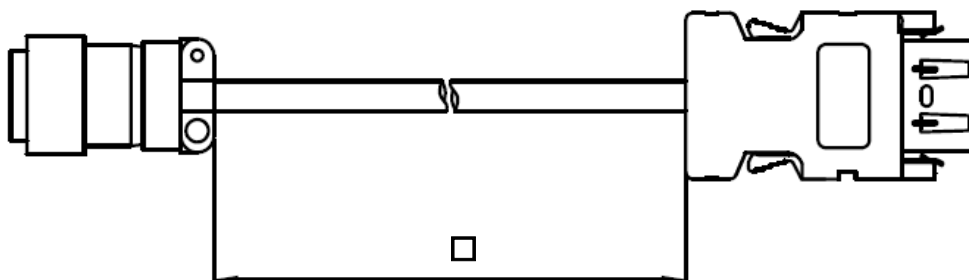

Power line connectors

Parts number: SDA-PWCNL1 (100W, 200W, 400W, 750W motors without brake)

SDA-PWCNL2 (100W, 200W, 400W, 750W motors with brake)

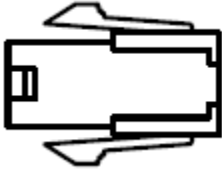

Parts number: SDA-PWCNM1 (low inertia 1KW, 1.5KW, 2KW, 3KW motors)

(medium inertia 1KW, 1.5KW)

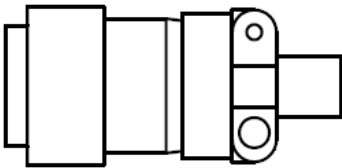

Parts number: SDA-PWCNM2 (medium inertia 2KW, 3KW)

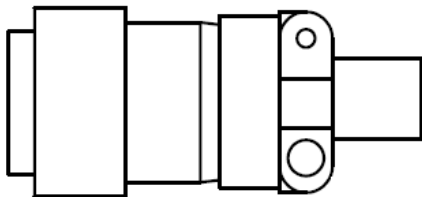

Power cables

Low inertia motor

Parts number: SDA-PWCNL  $\Delta$ - $\square$ M-L/H (100W, 200W, 400W, 750W motors)

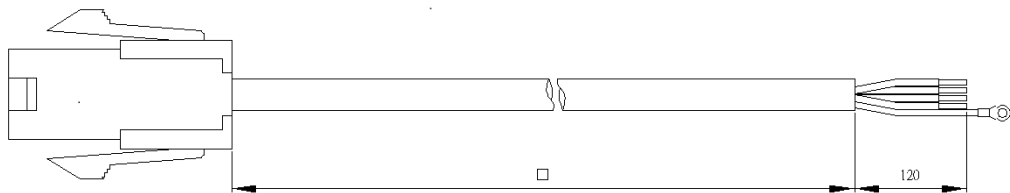

$\Delta=1$	$\square=2$	SDA-PWCNL1-2M-L/H
	$\square=5$	SDA-PWCNL1-5M-L/H
	$\square=10$	SDA-PWCNL1-10M-L/H
$\Delta=2$	$\square=2$	SDA-PWCNL2-2M-L/H (with brake)
	$\square=5$	SDA-PWCNL2-5M-L/H (with brake)
	$\square=10$	SDA-PWCNL2-10M-L/H (with brake)

Low/medium inertia motor

Parts number: SDA-PWCNM1  $\Delta$  - $\square$ M-L/H (low inertia 1KW, 1.5KW, 2KW, 3KW motors)  
(medium inertia 1KW, 1.5KW)

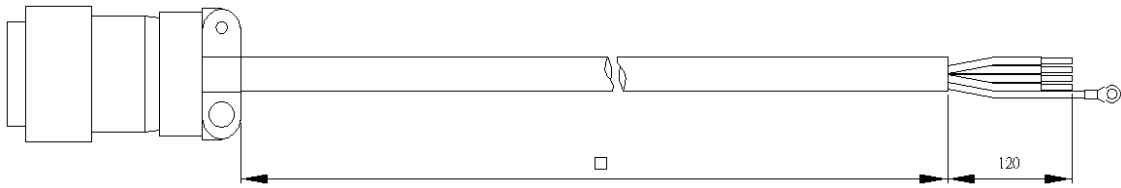

-	$\square=2$	SDA-PWCNM1-2M-L/H
	$\square=5$	SDA-PWCNM1-5M-L/H
	$\square=10$	SDA-PWCNM1-10M-L/H
$\Delta=B$	$\square=2$	SDA-PWCNM1B-2M-L/H (with brake)
	$\square=5$	SDA-PWCNM1B-5M-L/H (with brake)
	$\square=10$	SDA-PWCNM1B-10M-L /H (with brake)

Medium inertia motor

Parts number: SDA-PWCNM2  $\Delta$  - $\square$ M-L/H (medium inertia 2KW, 3KW)

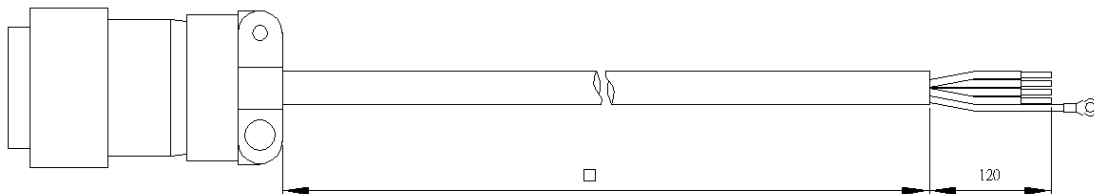

-	$\square=2$	SDE-PWCNM2-2M-L/H
	$\square=5$	SDE-PWCNM2-5M-L/H
	$\square=10$	SDE-PWCNM2-10M-L/H
$\Delta=B$	$\square=2$	SDE-PWCNM2B-2M-L/H (with brake)
	$\square=5$	SDE-PWCNM2B-5M-L/H (with brake)
	$\square=10$	SDE-PWCNM2B-10M-L/H (with brake)

USB communication cable

Parts number: SDA-USB3M

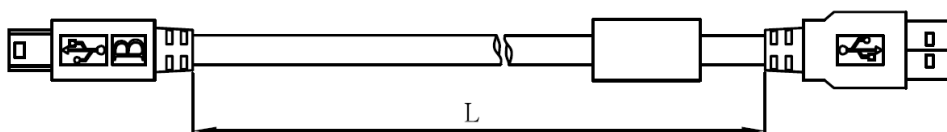

CN1 I/O connector

Parts number: SDA-CN1

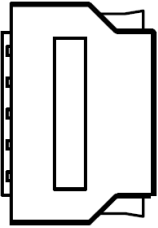

CN1 I/O cable

Parts number: SDA-TBL□M, □=05,1,2



CN1 I/O terminal block

Parts number: SDA-TBL50

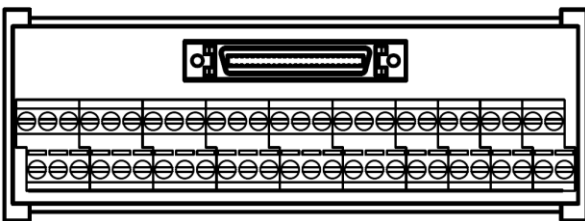

Absolute encoder option

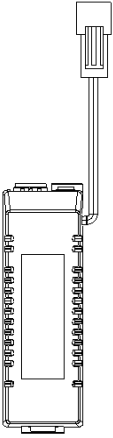
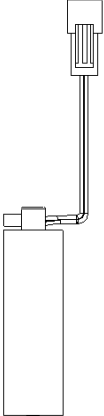
Absolute encoder battery set	Absolute encoder battery
Parts number: SDH-BAT-SET	Parts number: SDH-BAT
	



## 12.2. Brake resistor

### (1) Built-in brake resistor and relevant parameters

Drive type	Built-in resistor			
	Resistance( $\Omega$ )	Capacity(W)	PA10 setting	PA11 setting
SDE-010A2	100	20	100	500
SDE-020A2	100	20	100	500
SDE-040A2	100	20	100	500
SDE-050A2	100	20	100	1000
SDE-075A2	40	40	40	1000
SDE-100A2	40	40	40	1000
SDE-150A2	13	100	13	1000
SDE-200A2	13	100	13	1000
SDE-350A2	13	100	13	1000

### (2) Relevant parameter setting and specification of external brake resistor

To confirm that P and D terminal are in open-circuit status and that P and C terminal are connected with the external brake resistor.

Drive	External brake resistor recommendation				Brake resistor part No.
	Permissible Min. resistance ( $\Omega$ )	Capacity (W)	PA10	PA11	
SDE-010A2□□	100	300	100	300	ABR-300W100
SDE-020A2□□	100	300	100	300	ABR-300W100
SDE-040A2□□	100	300	100	300	ABR300W100
SDE-075A2□□	40	500	40	500	ABR-500W40
SDE-100A2□□	40	500	40	500	ABR-500W40
SDE-150A2□□	13	1000	13	1000	ABR-1000W13
SDE-200A2□□	13	1000	13	1000	ABR-1000W13
SDE-300A2□□	13	1000	13	1000	ABR-1000W13

### 12.3. Parameter communication address

<b>NO</b>	<b>Address</b>	<b>NO</b>	<b>Address</b>	<b>NO</b>	<b>Address</b>
PA01	0x0300	PA18	0x0322	PA35	0x0344
PA02	0x0302	PA19	0x0324	PA36	0x0346
PA03	0x0304	PA20	0x0326	PA37	0x0348
PA04	0x0306	PA21	0x0328	PA38	0x034A
PA05	0x0308	PA22	0x032A	PA39	0x034C
PA06	0x030A	PA23	0x032C	PA40	0x034E
PA07	0x030C	PA24	0x032E	PA41	0x0350
PA08	0x030E	PA25	0x0330	PA42	0x0352
PA09	0x0310	PA26	0x0332	PA43	0x0354
PA10	0x0312	PA27	0x0334	PA44	0x0356
PA11	0x0314	PA28	0x0336	PA45	0x0358
PA12	0x0316	PA29	0x0338	PA46	0x035A
PA13	0x0318	PA30	0x033A	PA47	0x035C
PA14	0x031A	PA31	0x033C	PA48	0x035E
PA15	0x031C	PA32	0x033E	PA49	0x0360
PA16	0x031E	PA33	0x0340	PA50	0x0362
PA17	0x0320	PA34	0x0342		
<b>NO</b>	<b>Address</b>	<b>NO</b>	<b>Address</b>	<b>NO</b>	<b>Address</b>
PB01	0x0400	PB18	0x0422	PB35	0x0444
PB02	0x0402	PB19	0x0424	PB36	0x0446
PB03	0x0404	PB20	0x0426	PB37	0x0448
PB04	0x0406	PB21	0x0428	PB38	0x044A
PB05	0x0408	PB22	0x042A	PB39	0x044C
PB06	0x040A	PB23	0x042C	PB40	0x044E
PB07	0x040C	PB24	0x042E	PB41	0x0450
PB08	0x040E	PB25	0x0430	PB42	0x0452
PB09	0x0410	PB26	0x0432	PB43	0x0454
PB10	0x0412	PB27	0x0434	PB44	0x0456
PB11	0x0414	PB28	0x0436	PB45	0x0458
PB12	0x0416	PB29	0x0438	PB46	0x045A
PB13	0x0418	PB30	0x043A	PB47	0x045C
PB14	0x041A	PB31	0x043C	PB48	0x045E
PB15	0x041C	PB32	0x043E	PB49	0x0460
PB16	0x041E	PB33	0x0440	PB50	0x0462
PB17	0x0420	PB34	0x0442		

<b>NO</b>	<b>Address</b>	<b>NO</b>	<b>Address</b>	<b>NO</b>	<b>Address</b>
PC01	0x0500	PC21	0x0528	PC41	0x0550
PC02	0x0502	PC22	0x052A	PC42	0x0552
PC03	0x0504	PC23	0x052C	PC43	0x0554
PC04	0x0506	PC24	0x052E	PC44	0x0556
PC05	0x0508	PC25	0x0530	PC45	0x0558
PC06	0x050A	PC26	0x0532	PC46	0x055A
PC07	0x050C	PC27	0x0534	PC47	0x055C
PC08	0x050E	PC28	0x0536	PC48	0x055E
PC09	0x0510	PC29	0x0538	PC49	0x0560
PC10	0x0512	PC30	0x053A	PC50	0x0562
PC11	0x0514	PC31	0x053C	PC51	0x0564
PC12	0x0516	PC32	0x053E	PC52	0x0566
PC13	0x0518	PC33	0x0540	PC53	0x0568
PC14	0x051A	PC34	0x0542	PC54	0x056A
PC15	0x051C	PC35	0x0544	PC55	0x056C
PC16	0x051E	PC36	0x0546	PC56	0x056E
PC17	0x0520	PC37	0x0548	PC57	0x0570
PC18	0x0522	PC38	0x054A	PC58	0x0572
PC19	0x0524	PC39	0x054C	PC59	0x0574
PC20	0x0526	PC40	0x054E	PC60	0x0576
<b>NO</b>	<b>Address</b>	<b>NO</b>	<b>Address</b>	<b>NO</b>	<b>Address</b>
PD01	0x0600	PD15	0x061C	PD29	0x0638
PD02	0x0602	PD16	0x061E	PD30	0x063A
PD03	0x0604	PD17	0x0620	PD31	0x063C
PD04	0x0606	PD18	0x0622	PD32	0x063E
PD05	0x0608	PD19	0x0624	PD33	0x0640
PD06	0x060A	PD20	0x0626	PD34	0x0642
PD07	0x060C	PD21	0x0628	PD35	0x0644
PD08	0x060E	PD22	0x062A	PD36	0x0646
PD09	0x0610	PD23	0x062C	PD37	0x0648
PD10	0x0612	PD24	0x062E	PD38	0x064A
PD11	0x0614	PD25	0x0630	PD39	0x064C
PD12	0x0616	PD26	0x0632	PD40	0x064E
PD13	0x0618	PD27	0x0634		
PD14	0x061A	PD28	0x0636		

<b>NO</b>	<b>Address</b>	<b>NO</b>	<b>Address</b>	<b>NO</b>	<b>Address</b>
PE01	0x0700	PE34	0x0742	PE67	0x0784
PE02	0x0702	PE35	0x0744	PE68	0x0786
PE03	0x0704	PE36	0x0746	PE69	0x0788
PE04	0x0706	PE37	0x0748	PE70	0x078A
PE05	0x0708	PE38	0x074A	PE71	0x078C
PE06	0x070A	PE39	0x074C	PE72	0x078E
PE07	0x070C	PE40	0x074E	PE73	0x0790
PE08	0x070E	PE41	0x0750	PE74	0x0792
PE09	0x0710	PE42	0x0752	PE75	0x0794
PE10	0x0712	PE43	0x0754	PE76	0x0796
PE11	0x0714	PE44	0x0756	PE77	0x0798
PE12	0x0716	PE45	0x0758	PE78	0x079A
PE13	0x0718	PE46	0x075A	PE79	0x079C
PE14	0x071A	PE47	0x075C	PE80	0x079E
PE15	0x071C	PE48	0x075E	PE81	0x07A0
PE16	0x071E	PE49	0x0760	PE82	0x07A2
PE17	0x0720	PE50	0x0762	PE83	0x07A4
PE18	0x0722	PE51	0x0764	PE84	0x07A6
PE19	0x0724	PE52	0x0766	PE85	0x07A8
PE20	0x0726	PE53	0x0768	PE86	0x07AA
PE21	0x0728	PE54	0x076A	PE87	0x07AC
PE22	0x072A	PE55	0x076C	PE88	0x07AE
PE23	0x072C	PE56	0x076E	PE89	0x07B0
PE24	0x072E	PE57	0x0770	PE90	0x07B2
PE25	0x0730	PE58	0x0772	PE91	0x07B4
PE26	0x0732	PE59	0x0774	PE92	0x07B6
PE27	0x0734	PE60	0x0776	PE93	0x07B8
PE28	0x0736	PE61	0x0778	PE94	0x07BA
PE29	0x0738	PE62	0x077A	PE95	0x07BC
PE30	0x073A	PE63	0x077C	PE96	0x07BE
PE31	0x073C	PE64	0x077E	PE97	0x07C0
PE32	0x073E	PE65	0x0780	PE98	0x07C2
PE33	0x0740	PE66	0x0782	PE99	0x07C4

<b>NO</b>	<b>Address</b>	<b>NO</b>	<b>Address</b>	<b>NO</b>	<b>Address</b>
PF01	0x0800	PF34	0x0842	PF67	0x0884
PF02	0x0802	PF35	0x0844	PF68	0x0886
PF03	0x0804	PF36	0x0846	PF69	0x0888
PF04	0x0806	PF37	0x0848	PF70	0x088A
PF05	0x0808	PF38	0x084A	PF71	0x088C
PF06	0x080A	PF39	0x084C	PF72	0x088E
PF07	0x080C	PF40	0x084E	PF73	0x0890
PF08	0x080E	PF41	0x0850	PF74	0x0892
PF09	0x0810	PF42	0x0852	PF75	0x0894
PF10	0x0812	PF43	0x0854	PF76	0x0896
PF11	0x0814	PF44	0x0856	PF77	0x0898
PF12	0x0816	PF45	0x0858	PF78	0x089A
PF13	0x0818	PF46	0x085A	PF79	0x089C
PF14	0x081A	PF47	0x085C	PF80	0x089E
PF15	0x081C	PF48	0x085E	PF81	0x08A0
PF16	0x081E	PF49	0x0860	PF82	0x08A2
PF17	0x0820	PF50	0x0862	PF83	0x08A4
PF18	0x0822	PF51	0x0864	PF84	0x08A6
PF19	0x0824	PF52	0x0866	PF85	0x08A8
PF20	0x0826	PF53	0x0868	PF86	0x08AA
PF21	0x0828	PF54	0x086A	PF87	0x08AC
PF22	0x082A	PF55	0x086C	PF88	0x08AE
PF23	0x082C	PF56	0x086E	PF89	0x08B0
PF24	0x082E	PF57	0x0870	PF90	0x08B2
PF25	0x0830	PF58	0x0872	PF91	0x08B4
PF26	0x0832	PF59	0x0874	PF92	0x08B6
PF27	0x0834	PF60	0x0876	PF93	0x08B8
PF28	0x0836	PF61	0x0878	PF94	0x08BA
PF29	0x0838	PF62	0x087A	PF95	0x08BC
PF30	0x083A	PF63	0x087C	PF96	0x08BE
PF31	0x083C	PF64	0x087E	PF97	0x08C0
PF32	0x083E	PF65	0x0880	PF98	0x08C2
PF33	0x0840	PF66	0x0882	PF99	0x08C4

## 12.4. Version information

Version: V1.01

Issue date: Aug. 2017

Proofreader: Yaochou Shu