

MOLDED CASE CIRCUIT BREAKER

EARTH LEAKAGE CIRCUIT BREAKER



 **MIRDC**
ISO 9001
4A6Y010-10

 **MIRDC**
ISO 14001
4A6E003-10



MCCB Frame Size Selection Table

Frame Size	Type	Rated Breaking Capacity (kA)					Pole	Rated Current In(A)	Accessory		
		IEC60947-2							Blank	No Acc.	
		220V	380V	415V	440V	500V					
30	CN	2.5	1.5	1.5	-	-	2, 3	3, 5, 10, 15, 20, 30.	Blank	No Acc.	
	SN	5	2.5	2.5	2.5	1.5	3		AX	Auxiliary Switch	
50	CN	5	2.5	2.5	2.5	1.5	2, 3	10, 15, 20, 30, 40, 50.	AL	Alarm Switch	
	SN	10	7.5	7.5	7.5	5	2, 3, 4		SHT	Shunt Trip	
60	HN	25	15	10	10	7.5	2, 3, 4	10, 15, 20, 25, 30, 40, 50, 60.	UVT	Under Voltage Trip	
	HBN	50	30	25	25	15	3		10, 15, 20, 30, 40, 50, 60.		
	FTD	25	5	5	-	-	1		15, 20, 30, 40, 50, 60, 75, 100		
63	SN	10	7.5	7.5	7.5	5	2, 3, 4	10, 15, 16, 20, 25, 30, 32, 40, 50, 60, 63			
	HN	25	15	10	10	5	2, 3, 4				
	MN	15	10	10	7.5	5	2, 3				
	SN	25	15	10	10	7.5	2, 3		10, 15, 20, 30, 40, 50, 60, 75, 100.		
	HN	50	30	25	25	15	2, 3, 4				
100	HS	125	85	85	70	50	3, 4	40, 50, 63, 80, 100.			
	BTD	25	15	10	10	5*	2, 3, 4				
	STD	50	30	25	25	5*	2, 3, 4		15, 16, 20, 25, 30, 32, 40, 50, 60, 63, 75, 80, 100		
	LTD	85	36	36	32	5*	2, 3, 4				
	SN	30	22	22	15	7.5	2, 3, 4		15, 20, 30, 40, 50, 60, 75, 100, 125.		
125	HN	50	30	25	25	15	2, 3, 4	15, 20, 30, 40, 50, 60, 75, 100, 125.			
	LTD	85	36	36	32	5*	2, 3, 4				
	HTA	100	50	50	50	10*	2, 3, 4		10, 15, 16, 20, 25, 30, 32, 40, 50, 60, 63, 70, 75, 80, 100, 125.		
160	RTA	100	70	70	50	10*	2, 3, 4	125, 140, 160.			
	SN	50	30	25	25	15	2, 3, 4				
	HN	85	36	36	32	20	3, 4				
250	HS	125	85	85	70	50	3, 4	40, 50, 60, 63, 70, 75, 80, 100, 125, 140, 150, 160.			
	HTA	100	50	50	50	10*	3, 4				
	RTA	100	70	70	50	10*	3, 4				
400	CN	30	22	15	15	7.5	2, 3, 4	125, 150, 175, 200, 225, 250.			
	SN	50	30	25	25	15	3, 4				
	HN	85	36	36	32	20	3, 4		175, 200, 225, 250.		
	HTA	100	50	50	50	10*	3, 4				
	RTA	100	70	70	50	10*	3, 4		175, 200, 225, 250.		
630s	HS	125	85	85	70	50	3, 4	250, 300, 350, 400.			
	CN	35	25	25	22	14	2, 3, 4				
	SN	50	35	35	30	20	3, 4				
	HN	85	50	50	42	25	3, 4				
	RN	100	70	70	55	42	3, 4				
630	UN	125	85	85	85	65	3, 4	400, 500, 600, 630.			
	STD	36	25	25	25	10*	3, 4				
	LTD	65	36	36	36	10*	3, 4				
	HTD	85	50	50	50	10*	3, 4				
	RTD	100	70	70	70	15*	3, 4				
800	CN	35	25	25	22	14	2, 3, 4	500, 630.			
	SN	50	35	35	30	20	3, 4				
	HN	85	50	50	50	25	3, 4				
	RN	100	70	70	70	42	3, 4				
	UN	125	100	85	85	65	3, 4				
1000	CN	50	35	35	30	20	3, 4	700, 800.			
	SN	85	50	50	50	25	3, 4				
	HN	100	70	70	70	42	3, 4				
	RN	125	100	85	85	65	3, 4				
1200	HS	130	100	85	85	65	3	1000			
1600	HS	130	100	85	85	65	3	1200			
1600	HS	130	100	85	85	65	3	1400, 1600.			

Note 1. There is no SHT for 100HS, 30A and below.
 2. There is no UVT for 100HS, 160HS, 250HS.
 3. Mark * kA rating is 690V.

ELCB Frame Size Selection Table

Frame Size	Rated Breaking Capacity (kA)				Pole	Rated Current In(A)	Accessory	
	Type	IEC60947-2						
		220V	380V	440V				
50	SN	10	7.5	7.5	3, 4	15, 20, 30, 40, 50.	Blank	No Acc.
100	SN	25	15	10	3, 4	15, 20, 30, 40, 50, 60, 75, 100.	AX	Auxiliary Switch
	HN	50	30	25	3, 4		AL	Alarm Switch
160	SN	50	30	25	3, 4	125, 140, 160.	SHT	Shunt Trip
250	SN	50	30	25	3, 4	175, 200, 225, 250.	UVT	Under Voltage Trip
400	SN	50	35	30	3, 4	250, 300, 350, 400.		
	HN	85	50	42	3, 4			
	RN	100	70	55	3, 4			
	UN	125	85	85	3, 4			
630	HN	85	50	50	3, 4	500, 630.		
	RN	100	70	70	3, 4			
800	UN	125	100	85	3, 4	700, 800.		
	SN	85	50	50	3, 4			
800	HN	100	70	70	3, 4	700, 800.		
	RN	125	100	85	3, 4			





BMA Series Frame Size Selection Table

Frame Size	Type	Rated Breaking Capacity (kA)			Pole	Ir Adjustable	Rated Current In(A)	Accessory	
		IEC60947-2						Blank	No Acc.
		220V(240V)	380V(415V)	690V					
125	STA	85	25	8	3, 4	0.8-0.9-1.0	15, 16, 20, 25, 30, 32, 40, 50, 60, 63, 75, 80, 100, 125	Blank	No Acc.
	LTA	85	36	8				AX	Auxiliary Switch
	HTA	100	50	10				AL	Alarm Switch
160	STA	85	25	8	3, 4	0.8-0.9-1.0	40, 50, 60, 63, 70, 75, 80, 100, 125, 140, 150, 160	SHT	Shunt Trip
	LTA	85	36	8				UVT	Under Voltage Trip
	HTA	100	50	10					
250	STA	85	25	8	3, 4	0.8-0.9-1.0	175, 200, 225, 250		
	LTA	85	36	8					
	HTA	100	50	10					
400	LTA	70	36	8	3, 4	0.8-0.9-1.0	250, 300, 350, 400		
	HTA	85	50	10					
	RTA	100	70	15					
630s	STD	36	25	10	3, 4	N/A	400, 500, 600, 630		
	LTD	65	36	10					
	HTD	85	50	10					
	RTD	100	70	15					
630	HTD	85	50	10	3, 4	N/A	500, 600, 630		
	RTD	100	70	15					
	HTA	85	50	10					
	RTA	100	70	15					
800	HED	85	50	10	3, 4	0.4-0.48-0.56-0.64-0.72-0.8-0.9-1.0	630		
	RED	100	70	15					
	HTD	85	50	10					
	RTD	100	70	15					
800	HTA	85	50	10	3, 4	0.8-0.9-1.0	700, 800		
	RTA	100	70	15					
	HED	85	50	10					
	RED	100	70	15					
1250	HED	-	50	35	3, 4	0.4-0.45-0.5-0.6-0.63-0.7-0.8-0.9-1	1250		
	RED	-	70	45					
1600	HED	-	50	35	3, 4	0.4-0.45-0.5-0.6-0.63-0.7-0.8-0.9-1	1600		
	RED	-	70	45					





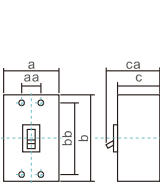

MCCB/ELCB Breaking Capacity Selection Table

Series	Rated Breaking Capacity (kA)	Frame Size/ Rated Current In (A)													
		IEC60947-2													
		30	50/60	100	125	160	250	400	630	800	1000	1200	1600		
BM	100kA									630-UN	800-RN	1000-HS	1200-HS	1600-HS	
	85kA			100-HS		160-HS	250-HS	400-UN							
	70kA				125-RTA	160-RTA	250-RTA	400-RN	630-RN 630s-RTD	800-HN					
	50kA				125-HTA	160-HTA	250-HTA	400-HN	630-HN 630s-HTD	800-SN					
	35/36kA			100-LTD	125-LTD	160-HN	250-HN	400-SN	630-SN 630s-LTD	800-CN					
	30kA		60-HBN	100-HN 100-STD		160-SN	250-SN								
	25kA				125-HN				630s-STD						
	15kA		60-HN 63-HN	100-SN 100-BTD	125-SN										
	10kA			100-MN											
	7.5kA		60-SN 63-SN												
BL	2.5kA	30-SN	50-CN												
	1.5kA	30-CN													
	100kA									630-UN	800-RN				
	85kA							400-RN							
	70kA							400-RN	630-RN	800-HN					
	50kA							400-HN	630-HN	800-SN					
	35kA							400-SN							
	30kA			100-HN		160-SN	250-SN								
	15kA			100-SN											
	10kA														
7.5kA		50-SN													

Molded Case Circuit Breaker





Frame size (AF) (Inm)		30		50		60			
Type		BM30-CN		BM30-SN		BM50-CN		BM60-HBN	
Appearance									
Rated current In (A) at ambient temp. 40°C		3, 5, 10, 15, 20, 30.		3, 5, 10, 15, 20, 30.		10, 15, 20, 30, 40, 50.		10, 15, 20, 30, 40, 50, 60.	
Number of poles (P)		2	3	2	3	2	3	3	
Rated insulation voltage Ui (V)	AC	690		800		800		800	
	DC	—		—		—		—	
Rated operational voltage Ue (V AC)		500		500		500		500	
Uimp(kV)		6		6		6		8	
Dimensions 	a	45	67.5	50	75	50	75	90	
	b	96		130		130		155	
	c	52		68		68		68	
	ca	67		90		90		90	
	bb	84		111		111		132	
	aa	23.5		25		25		30	
Weight (kg)		0.3	0.4	0.45	0.65	0.45	0.65	1.3	
Rated breaking capacity (kA)	IEC 60947-2 EN 60947-2 Icu AC	500V(690V)	—		1.5		1.5		15
		440V	—		2.5		2.5		25
		415V	1.5	2.5	2.5	2.5	25		
		380V	1.5	2.5	2.5	30			
		220V(240V)	2.5	5	5	50			
	DC	250V	—		—		—		—
125V		—		—		—		—	
Connection		Clamp terminal		Clamp terminal		Clamp terminal		Clamp terminal	
Optional accessories	Alarm switch (AL)	—		○		○		○	
	Auxiliary switch (AX)	—		○		○		○	
	Shunt trip (SHT)	—		○		○		○	
	Under-voltage trip (UVT)	—		○		○		○	
	Rotary handle (EH)	—		●		●		●	
	Terminal cover (TC)	●		●		●		●	
	Box lug (TL)	●		●		●		●	
Trip Unit		Hydraulic magnetic		Hydraulic magnetic		Hydraulic magnetic		Hydraulic magnetic	
Tripping button		—		Equipped		Equipped		Equipped	

Note 1. "●" which can be installed by client, "○" which have to be installed by manufacturer. "—" which is not available.
 Above accessories table is for 3P breaker.
 2. Ics= 50% Icu
 3. Adjustable thermal: 80%~100% In.

63			100														
BM63-SN			BM63-HN			BM100-FTD			BM100-MN			BM100-SN			BM100-HN		
																	
10, 15, 16, 20, 25, 30, 32, 40, 50, 60, 63			10, 15, 16, 20, 25, 30, 32, 40, 50, 60, 63			15, 20, 30, 40, 50, 60, 75, 100.			10, 15, 20, 30, 40, 50, 60, 75, 100.			10, 15, 20, 30, 40, 50, 60, 75, 100.			10, 15, 20, 30, 40, 50, 60, 75, 100.		
2	3	4	2	3	4	1	2	3	2	3	2	3	4	2	3	4	
800			800			690			800			800			800		
—			—			—			—			250*			—		
500			500			415			500			500			500		
8			8			6			6			6			8		
50	75	100	50	75	100	25.4	50	75	50	75	50	75	60	90	120		
130			130			130			130			130			155		
68			68			60			68			68			68		
90			90			91			90			90			90		
111			111			111			111			111			132		
25			25			—			25			25			30		
0.45	0.65	0.85	0.45	0.65	0.85	0.29	0.45	0.65	0.45	0.65	0.45	0.65	0.9	1.3	1.6		
5			5			—			5			7.5			15		
7.5			10			—			7.5			10			25		
7.5			10			5			10			10			25		
7.5			15			5			10			15			30		
10			25			25			15			25			50		
—			—			—			—			10*			—		
—			—			—			—			15*			—		
Clamp terminal			Clamp terminal			Clamp terminal			Clamp terminal			Clamp terminal			Clamp terminal		
○			○			—			○			○			○		
○			○			—			○			○			○		
○			○			—			○			○			○		
○			○			—			○			○			○		
●			●			—			●			●			●		
●			●			—			●			●			●		
●			●			●			●			●			●		
Hydraulic magnetic			Hydraulic magnetic			Thermal magnetic			Hydraulic magnetic			Hydraulic magnetic			Hydraulic magnetic		
Equipped			Equipped			Equipped			Equipped			Equipped			Equipped		

Note 1. Breaking Capacity of BM100-FTD is 5kA at 380V/415V/440V
 2.* DC application MCCB trip characteristic is different from AC type, please specify when place the order.

Molded Case Circuit Breaker

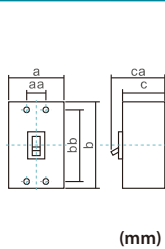
Frame size (AF) (Inm)		100										
Model		BM100-HS		BM100-BTD			BM100-STD			BM100-LTD		
Appearance												
Rated current In (A) at ambient temp. 40°C		40, 50, 63, 80, 100.		15, 16, 20, 25, 30, 32, 40, 50, 60, 63, 75, 80, 100			15, 16, 20, 25, 30, 32, 40, 50, 60, 63, 75, 80, 100			10,15,16,20,25,30,32,40, 50,60,63,70,75,80,100		
Number of poles (P)		3	4	2	3	4	2	3	4	2	3	4
Rated insulation voltage Ui (V)	AC	800		800			800			800		
	DC	—		—			—			—		
Rated operational voltage Ue (V AC)		500		690			690			690		
Uimp(kV)		8		8			8			8		
Dimensions  (mm)	a	105	140	50	75	100	50	75	100	50	75	100
	b	165		130			130			130		
	c	86		68			68			68		
	ca	112		90			90			90		
	bb	126		111			111			111		
	aa	35		25			25			—		25
	Weight (kg)	2.1	2.6	0.5	0.7	0.9	0.5	0.7	0.9	0.5	0.7	0.9
Rated breaking capacity (kA)	IEC 60947-2 EN 60947-2 Icu AC	500V(690V)	50		(5)			(5)			20(5)	
		440V	70		10			25			32	
		415V	85		10			25			36	
		380V	85		15			30			36	
		220V(240V)	125		25			50			85	
	DC	250V	—		—			—			—	
		125V	—		—			—			—	
Connection		Clamp terminal		Clamp terminal			Clamp terminal			Clamp terminal		
Optional accessories	Alarm switch (AL)	○		●			●			●		
	Auxiliary switch (AX)	○		●			●			●		
	Shunt trip (SHT)	○		●			●			●		
	Under-voltage trip (UVT)	—		●			●			●		
	Rotary handle (EH)	●		●			●			●		
	Terminal cover (TC)	●		●			●			●		
	Box lug (TL)	●		●			●			●		
Trip Unit		Thermal magnetic		Thermal magnetic			Thermal magnetic			Thermal magnetic		
Tripping button		Equipped		Equipped			Equipped			Equipped		

Note 1. "●" which can be installed by client, "○" which have to be installed by manufacturer. "—" which is not available.
 Above accessories table is for 3P breaker.
 2. Ics= 50% Icu
 3. Adjustable thermal: 80%~100% In.

Molded Case Circuit Breaker

125

BM125-SN

BM125-HN

BM125-LTD

BM125-HTA

BM125-RTA



10, 15, 20, 30, 40, 50, 60, 75, 100, 125.			10, 15, 20, 30, 40, 50, 60, 75, 100, 125.			15, 16, 20, 25, 30, 32, 40, 50, 60, 63, 75, 80, 100, 125.			10,15,16,20,25,30,32,40, 50,60,63,70,75,80,100,125.			10,15,16,20,25,30,32,40, 50,60,63,70,75,80,100,125.		
2	3	4	2	3	4	2	3	4	2	3	4	2	3	4
800			800			800			800			800		
—			—			—			—			—		
500			500			690			690			690		
8			8			8			8			8		
60	90	120	60	90	120	50	75	100	90	120		90	120	
155			155			130			155			155		
68			68			68			68			68		
90			90			90			90			90		
132			132			111			132			132		
30			30			25			30			30		
0.5	0.7	0.9	0.5	0.7	0.9	0.5	0.7	0.9	1	1.2	1.5	1	1.2	1.5
7.5			15			(5)			25(10)			25(10)		
15			25			32			50			50		
22			25			36			50			70		
22			30			36			50			70		
30			50			85			100			100		
—			—			—			—			—		
—			—			—			—			—		
Clamp terminal			Clamp terminal			Clamp terminal			Clamp terminal			Clamp terminal		
○			○			●			●			●		
○			○			●			●			●		
○			○			●			●			●		
—	○	○	—	○	○	●			●			●		
●			●			●			●			●		
●			●			●			●			●		
●			●			●			●			●		
Hydraulic magnetic			Hydraulic magnetic			Thermal magnetic			"Adjustable Thermal Fixed magnetic"			"Adjustable Thermal Fixed magnetic"		
Equipped			Equipped			Equipped			Equipped			Equipped		

BM

Series

BL

Series

ACC.





DIM.

Curve.

Other

Molded Case Circuit Breaker

80% ~ 100% Adj. (A)

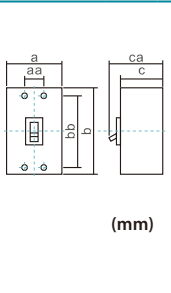
Frame size (AF) (Inm)		160											
Model		BM160-SN			BM160-HN		BM160-HTA		BM160-RTA		BM160-HS		
Appearance													
Rated current In (A) at ambient temp. 40°C		125, 140, 160.			125, 140, 160.		40, 50, 60, 63, 70, 75, 80, 100, 125, 140, 150, 160		40, 50, 60, 63, 70, 75, 80, 100, 125, 140, 150, 160		125, 140, 160.		
Number of poles (P)		2	3	4	3	4	3	4	3	4	3	4	
Rated insulation voltage Ui (V)		AC		800		800		800		800		690	
		DC		—		—		—		—		—	
Rated operational voltage Ue (V AC)		500			500		690		690		500		
Uimp(kV)		8			8		8		8		8		
Dimensions		a	105	105	140	105	140	105	140	105	140	105	140
		b	165			165		165		165		165	
		c	68			68		68		68		86	
		ca	92			92		92		92		112	
		bb	126			126		126		126		126	
		aa	35			35		35		35		35	
		(mm)											
Weight (kg)		1.3	1.5	1.9	1.5	1.9	1.5	1.9	1.5	1.9	2.1	2.6	
Rated breaking capacity (kA)	IEC 60947-2 EN 60947-2 Icu AC	500V(690V)	15			20		25(10)		25(10)		50	
		440V	25			32		50		50		70	
		415V	25			36		50		70		85	
		380V	30			36		50		70		85	
		220V(240V)	50			85		100		100		125	
	DC	250V	—			—		—		—		—	
		125V	—			—		—		—		—	
	Connection		Clamp terminal			Clamp terminal		Clamp terminal		Clamp terminal		Clamp terminal	
Optional accessories	Alarm switch (AL)	●			●		●		●		○		
	Auxiliary switch (AX)	●			●		●		●		○		
	Shunt trip (SHT)	●			●		●		●		○		
	Under-voltage trip (UVT)	●			●		●		●		—		
	Rotary handle (EH)	●			●		●		●		●		
	Terminal cover (TC)	●			●		●		●		●		
	Box lug (TL)	●			●		—		—		●		
Trip Unit		Adj. thermal Fixed magnetic			Adj. thermal Fixed magnetic		Adj. thermal Fixed magnetic		Adj. thermal Fixed magnetic		Thermal magnetic		
Tripping button		Equipped			Equipped		Equipped		Equipped		Equipped		

Note * DC application MCCB trip characteristic is different from AC type, please specify when place the order.

80% ~ 100% Adj. (A)

250

BM250-CN

BM250-SN

BM250-HN

BM250-HTA

BM250-RTA

BM250-HS







125, 150, 175, 200, 225, 250.			125, 150, 175, 200, 225, 250.		175, 200, 225, 250.		175, 200, 225, 250.		175, 200, 225, 250.		175, 200, 225, 250.			
2	3	4	3	4	3	4	3	4	3	4	3	4		
800			800		800		800		800		800			
250*	—	—	—	—	—	—	—	—	—	—	—	—		
500			500		500		690		690		500			
8			8		8		8		8		8			
105	105	140	105	140	105	140	105	140	105	140	105	140	105	140
165			165		165		165		165		165			
68			68		68		68		68		86			
92			92		92		92		92		112			
126			126		126		126		126		126			
35			35		35		35		35		35			
1.3	1.5	1.9	1.5	1.9	1.5	1.9	1.5	1.9	1.5	1.9	2.1	2.6		
7.5			15		20		25(10)		25(10)		50			
15			25		32		50		50		70			
15			25		36		50		70		85			
22			30		36		50		70		85			
30			50		85		100		100		125			
10*	—	—	—	—	—	—	—	—	—	—	—	—		
15*	—	—	—	—	—	—	—	—	—	—	—	—		
Clamp terminal			Clamp terminal		Clamp terminal		Clamp terminal		Clamp terminal		Clamp terminal			
●	●	●	●	●	●	●	●	●	●	●	○	○		
●	●	●	●	●	●	●	●	●	●	●	○	○		
●	●	●	●	●	●	●	●	●	●	●	○	○		
●	●	●	●	●	●	●	●	●	●	●	—	—		
●	●	●	●	●	●	●	●	●	●	●	●	●		
●	●	●	●	●	●	●	●	●	●	●	●	●		
●	●	●	●	●	●	●	●	●	●	●	●	●		
Adj. thermal Fixed magnetic			Adj. thermal Fixed magnetic		Adj. thermal Fixed magnetic		Adj. thermal Fixed magnetic		Adj. thermal Fixed magnetic		Thermal magnetic			
Equipped			Equipped		Equipped		Equipped		Equipped		Equipped			







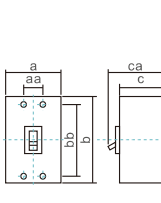

Note * DC application MCCB trip characteristic is different from AC type, please specify when place the order.

BM
Series
BL
Series
ACC.
DIM.
Curve.
Other

Molded Case Circuit Breaker

Frame size (AF) (Inm)		400											
Model		BM400-CN			BM400-SN		BM400-HN		BM400-RN		BM400-UN		
Appearance													
Rated current In (A) at ambient temp. 40°C		250, 300, 350, 400.			250, 300, 350, 400.		250, 300, 350, 400.		250, 300, 350, 400.		250, 300, 350, 400.		
Number of poles (P)		2	3	4	3	4	3	4	3	4	3	4	
Rated insulation voltage Ui (V)		AC		690		690		690		690		690	
		DC		250*	—	—	—	—	—	—	—	—	—
Rated operational voltage Ue (V AC)		500			500		500		500		500		
Uimp(kV)		8			8		8		8		8		
Dimensions		a	140	140	185	140	185	140	185	140	185	140	185
		b	257			257		257		257		257	
		c	103			103		103		103		103	
		ca	155			155		155		155		155	
		bb	194			194		194		194		194	
		aa	44			44		44		44		44	
Weight (kg)		5.0	5.7	7.5	5.7	7.5	5.7	7.5	5.7	7.5	5.7	7.5	
Rated breaking capacity (kA)	IEC 60947-2 EN 60947-2 Icu	500V(690V)	14			20		25		42		65	
		440V	22			30		42		55		85	
		415V	25			35		50		70		85	
		380V	25			35		50		70		85	
		220V(240V)	35			50		85		100		125	
	DC	250V	10*	—	—	—	—	—	—	—	—	—	
		125V	15*	—	—	—	—	—	—	—	—	—	
Connection		Busbar / Without busbar			Busbar / Without busbar		Busbar / Without busbar		Busbar / Without busbar		Busbar / Without busbar		
Optional accessories	Alarm switch (AL)	●			●		●		●		●		
	Auxiliary switch (AX)	●			●		●		●		●		
	Shunt trip (SHT)	●			●		●		●		●		
	Under-voltage trip (UVT)	●			●		●		●		●		
	Rotary handle (EH)	●			●		●		●		●		
	Terminal cover (TC)	●			●		●		●		●		
	Box lug (TL)	●			●		●		●		●		
Trip Unit		Thermal magnetic			Thermal magnetic		Thermal magnetic		Thermal magnetic		Thermal magnetic		
Tripping button		Equipped			Equipped		Equipped		Equipped		Equipped		





Note 1. "●" which can be installed by client, "○" which have to be installed by manufacturer. "—" which is not available.
 Above accessories table is for 3P breaker.
 2. Ics= 50% Icu
 3. Adjustable thermal: 80%~100% In.
 4. * DC application MCCB trip characteristic is different from AC type, please specify when place the order.

BM630s-STD		BM630s-LTD		BM630s-HTD		BM630s-RTD		BM630s-STA		BM630s-LTA		BM630s-HTA		BM630s-RTA	
															
400, 500, 600, 630.		400, 500, 600, 630.		400, 500, 600, 630.		400, 500, 600, 630.		400, 500, 600, 630.		400, 500, 600, 630.		400, 500, 600, 630.		400, 500, 600, 630.	
3	4	3	4	3	4	3	4	3	4	3	4	3	4	3	4
1000		1000		1000		1000		1000		1000		1000		1000	
—		—		—		—		—		—		—		—	
690		690		690		690		690		690		690		690	
8		8		8		8		8		8		8		8	
140	185	140	185	140	185	140	185	140	185	140	185	140	185	140	185
257		257		257		257		257		257		257		257	
103		103		103		103		103		103		103		103	
155		155		155		155		155		155		155		155	
194		194		194		194		194		194		194		194	
44		44		44		44		44		44		44		44	
5.7	7	5.7	7	5.7	7	5.7	7	5.7	7	5.7	7	5.7	7	5.7	7
14(10)		20(10)		25(10)		42(15)		14(10)		20(10)		25(10)		42(15)	
25		36		50		70		25		36		50		70	
25		36		50		70		25		36		50		70	
25		36		50		70		25		36		50		70	
36		65		85		100		36		65		85		100	
—		—		—		—		—		—		—		—	
—		—		—		—		—		—		—		—	
Busbar / Without busbar		Busbar / Without busbar		Busbar / Without busbar		Busbar / Without busbar		Busbar / Without busbar		Busbar / Without busbar		Busbar / Without busbar		Busbar / Without busbar	
●	●	●	●	●	●	●	●	●	●	●	●	●	●	●	●
●	●	●	●	●	●	●	●	●	●	●	●	●	●	●	●
●	●	●	●	●	●	●	●	●	●	●	●	●	●	●	●
●	●	●	●	●	●	●	●	●	●	●	●	●	●	●	●
●	●	●	●	●	●	●	●	●	●	●	●	●	●	●	●
●	●	●	●	●	●	●	●	●	●	●	●	●	●	●	●
●	●	●	●	●	●	●	●	●	●	●	●	●	●	●	●
●	●	●	●	●	●	●	●	●	●	●	●	●	●	●	●
Thermal magnetic	Thermal magnetic	Thermal magnetic	Thermal magnetic	Thermal magnetic	"Adjustable Thermal Fixed magnetic"	"Adjustable Thermal Fixed magnetic"	"Adjustable Thermal Fixed magnetic"	"Adjustable Thermal Fixed magnetic"	"Adjustable Thermal Fixed magnetic"	"Adjustable Thermal Fixed magnetic"	"Adjustable Thermal Fixed magnetic"	"Adjustable Thermal Fixed magnetic"	"Adjustable Thermal Fixed magnetic"	"Adjustable Thermal Fixed magnetic"	
Equipped	Equipped	Equipped	Equipped	Equipped	Equipped	Equipped	Equipped	Equipped	Equipped	Equipped	Equipped	Equipped	Equipped	Equipped	





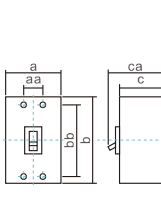

Note * DC application MCCB trip characteristic is different from AC type, please specify when place the order.

BM
Series
BL
Series
ACC.
DIM.
Curve.
Other

Molded Case Circuit Breaker





Frame size (AF) (Inm)		630										
Model		BM630-CN		BM630-SN		BM630-HN		BM630-RN		BM630-UN		
Appearance												
Rated current In (A) at ambient temp. 40°C		500, 600, 630.		500, 600, 630.		500, 630.		500, 630.		500, 630.		
Number of poles (P)		3	4	3	4	3	4	3	4	3	4	
Rated insulation voltage Ui (V)	AC	1000		1000		1000		1000		1000		
	DC	250*		250*		250*		—		—		
Rated operational voltage Ue (V AC)		500		500		500		500		500		
Uimp(kV)		8		8		8		8		8		
Dimensions  (mm)	a	210	280	210	280	210	280	210	280	210	280	
	b	275		275		275		275		275		
	c	103		103		103		103		103		
	ca	155		155		155		155		155		
	bb	243		243		243		243		243		
	aa	70		70		70		70		70		
Weight (kg)		10	13	10	13	10	13	10	13	10	13	
Rated breaking capacity (kA)	IEC 60947-2 EN 60947-2 Icu AC	500V(690V)	14		20		25		42		65	
		440V	22		30		50		70		85	
		415V	25		35		50		70		85	
		380V	25		35		50		70		100	
		220V(240V)	35		50		85		100		125	
	DC	250V	10*	—	20*	—	40*	—	—	—	—	—
125V		—		—		—		—		—		
Connection		Busbar / Without busbar		Busbar / Without busbar		Busbar / Without busbar		Busbar / Without busbar		Busbar / Without busbar		
Optional accessories	Alarm switch (AL)	●		●		●		●		●		
	Auxiliary switch (AX)	●		●		●		●		●		
	Shunt trip (SHT)	●		●		●		●		●		
	Under-voltage trip (UVT)	●		●		●		●		●		
	Rotary handle (EH)	●		●		●		●		●		
	Terminal cover (TC)	●		●		●		●		●		
	Box lug (TL)	●		●		●		●		●		
Trip Unit		Fixed thermal Adj. magnetic		Fixed thermal Adj. magnetic		Fixed thermal Adj. magnetic		Fixed thermal Adj. magnetic		Fixed thermal Adj. magnetic		
Tripping button		Equipped		Equipped		Equipped		Equipped		Equipped		

Note 1 "●" which can be installed by client, "○" which have to be installed by manufacturer. "—" which is not available.
 Above accessories table is for 3P breaker.
 2. Ics= 50% Icu
 3. * DC application MCCB trip characteristic is different from AC type, please specify when place the order.

800				1000	1200	1600		
BM800-CN		BM800-SN		BM800-HN	BM800-RN	BM1000-HS	BM1200-HS	BM1600-HS
								
700, 800.		700, 800.		700, 800.	700, 800.	1000	1200	1400, 1600.
3	4	3	4	3	4	3	3	3
690		690		1000	1000	1000	1000	1000
250*	—	250*	—	—	—	—	—	—
500		500		500	500	500	500	500
8		8		8	8	8	8	8
210	280	210	280	210	280	210	210	210
275		275		275	275	406	406	406
103		103		103	103	140	140	140
155		155		155	155	190	190	190
243		243		243	243	375	375	375
70		70		70	70	70	70	70
10.5	13.5	10.5	13.5	10.5	13.5	10.5	13.5	23
20		25		42	65	65	65	65
30		50		70	85	85	85	85
35		50		70	85	85	85	85
35		50		70	100	100	100	100
50		85		100	125	130	130	130
20*	—	40*	—	—	—	—	—	—
—		—		—	—	—	—	—
Busbar / Without busbar		Busbar / Without busbar		Busbar / Without busbar	Busbar / Without busbar	Busbar	Busbar	Busbar
●	●	●	●	●	●	○	○	○
●	●	●	●	●	●	○	○	○
●	●	●	●	●	●	○	○	○
●	●	●	●	●	●	○	○	○
●	●	●	●	●	●	—	—	—
●	●	●	●	●	●	—	—	—
●	●	●	●	●	●	●	●	●
Fixed thermal Adj. magnetic	Fixed thermal Adj. magnetic	Fixed thermal Adj. magnetic	Fixed thermal Adj. magnetic	Fixed thermal Adj. magnetic	Fixed thermal Adj. magnetic	Fixed thermal Adj. magnetic	Fixed thermal Adj. magnetic	Fixed thermal Adj. magnetic
Equipped	Equipped	Equipped	Equipped	Equipped	Equipped	Equipped	Equipped	Equipped





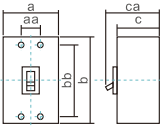



Note * DC application MCCB trip characteristic is different from AC type, please specify when place the order.

Molded Case Circuit Breaker (BMA Series)

Frame size (AF) (Inm)		125			160			250			400						
Model		BMA 125-STA	BMA 125-LTA	BMA 125-HTA	BMA 160-STA	BMA 160-LTA	BMA 160-HTA	BMA 250-STA	BMA 250-LTA	BMA 250-HTA	BMA 400-LTA	BMA 400-HTA	BMA 400-RTA				
Appearance																	
Rated current In (A) at ambient temp. 40°C		15,16,20,25,30,32,40,50,60,63,75,80,100,125A			40,50,60,63,70,75,80,100,125,140,150,160A			175,200,225,250A			250, 300, 350, 400A						
Number of poles (P)		3		4		3		4		3		4					
Rated insulation voltage Ui (V)		AC		800		800		800		800		800					
Rated operational voltage Ue(V AC)		690		690		690		690		690		690					
Uimp(kV)		8		8		8		8		8		8					
Dimensions		a	90	120	105	140	105	140	140	185							
		b	155	155	165	165	165	165	165	257	257						
		c	68	68	68	68	68	68	68	68	103	103					
		ca	92	92	92	92	92	92	92	92	155	155					
		bb	132	132	126	126	126	126	126	126	194	194					
		aa	30	30	35	35	35	35	35	35	44	44					
		(mm)															
Weight (kg)		0.7		0.9		1.5		1.9		1.5		1.9		5.7		7.5	
Rated breaking capacity (kA)	IEC 60947-2 EN 60947-2 Icu	AC	690V	8 kA	8 kA	10 kA	8 kA	8 kA	10 kA	8 kA	8 kA	10 kA	8 kA	10 kA	15 kA		
			415V	25 kA	36 kA	50 kA	25 kA	36 kA	50 kA	25 kA	36 kA	50 kA	36 kA	50 kA	70 kA		
			380V	25 kA	36 kA	50 kA	25 kA	36 kA	50 kA	25 kA	36 kA	50 kA	36 kA	50 kA	70 kA		
			220V(240V)	85 kA	85 kA	100 kA	85 kA	85 kA	100 kA	85 kA	85 kA	100 kA	70 kA	85 kA	100 kA		
Connection		Clamp terminal	Clamp terminal	Clamp terminal	Clamp terminal	Clamp terminal	Clamp terminal	Clamp terminal	Clamp terminal	Clamp terminal	Busbar	Busbar	Busbar				
Optional accessories	Alarm switch (AL)	●	●	●	●	●	●	●	●	●	●	●	●				
	Auxiliary switch (AX)	●	●	●	●	●	●	●	●	●	●	●	●				
	Shunt trip (SHT)	●	●	●	●	●	●	●	●	●	●	●	●				
	Under-voltage trip (UVT)	●	●	●	●	●	●	●	●	●	●	●	●				
	Rotary handle (EH)	●	●	●	●	●	●	●	●	●	●	●	●				
	Terminal cover (TC)	●	●	●	●	●	●	●	●	●	●	●	●				
Trip Unit		Adjustable Thermal Fixed Magnetic			Adjustable Thermal Fixed Magnetic			Adjustable Thermal Fixed Magnetic			Adjustable Thermal Fixed Magnetic						
Tripping button		Equipped	Equipped	Equipped	Equipped	Equipped	Equipped	Equipped	Equipped	Equipped	Equipped	Equipped	Equipped				

Note 1. Ics=100%Icu

630

BMA630s-STD		BMA630s-LTD		BMA630s-HTD		BMA630s-RTD		BMA630s-STA		BMA630s-LTA		BMA630s-HTA		BMA630s-RTA			
																	
400, 500, 600, 630A		400, 500, 600, 630A		400, 500, 600, 630A		400, 500, 600, 630A		400, 500, 600, 630A		400, 500, 600, 630A		400, 500, 600, 630A		400, 500, 600, 630A			
3	4	3	4	3	4	3	4	3	4	3	4	3	4	3	4	3	4
1000		1000		1000		1000		1000		1000		1000		1000			
690		690		690		690		690		690		690		690			
8		8		8		8		8		8		8		8			
140	185	140	185	140	185	140	185	140	185	140	185	140	185	140	185	140	185
257		257		257		257		257		257		257		257			
103		103		103		103		103		103		103		103			
155		155		155		155		155		155		155		155			
194		194		194		194		194		194		194		194			
44		44		44		44		44		44		44		44			
5.7	7	5.7	7	5.7	7	5.7	7	5.7	7	5.7	7	5.7	7	5.7	7	5.7	7
10 kA		10 kA		10 kA		15 kA		10 kA		10 kA		10 kA		15 kA			
25 kA		36 kA		50 kA		70 kA		25 kA		36 kA		50 kA		70 kA			
25 kA		36 kA		50 kA		70 kA		25 kA		36 kA		50 kA		70 kA			
36 kA		65 kA		85 kA		100 kA		36 kA		65 kA		85 kA		100 kA			
Clamp terminal		Clamp terminal		Clamp terminal		Clamp terminal		Clamp terminal		Clamp terminal		Clamp terminal		Clamp terminal			
●	●	●	●	●	●	●	●	●	●	●	●	●	●	●	●		
●	●	●	●	●	●	●	●	●	●	●	●	●	●	●	●		
●	●	●	●	●	●	●	●	●	●	●	●	●	●	●	●		
●	●	●	●	●	●	●	●	●	●	●	●	●	●	●	●		
●	●	●	●	●	●	●	●	●	●	●	●	●	●	●	●		
●	●	●	●	●	●	●	●	●	●	●	●	●	●	●	●		
Thermal magnetic	Thermal magnetic	Thermal magnetic	Thermal magnetic	Thermal magnetic	Adjustable Thermal Fixed magnetic	Adjustable Thermal Fixed magnetic	Adjustable Thermal Fixed magnetic	Adjustable Thermal Fixed magnetic	Adjustable Thermal Fixed magnetic	Adjustable Thermal Fixed magnetic	Adjustable Thermal Fixed magnetic	Adjustable Thermal Fixed magnetic	Adjustable Thermal Fixed magnetic	Adjustable Thermal Fixed magnetic	Adjustable Thermal Fixed magnetic		
Equipped	Equipped	Equipped	Equipped	Equipped	Equipped	Equipped	Equipped	Equipped	Equipped	Equipped	Equipped	Equipped	Equipped	Equipped	Equipped		

BM

Series

BL

Series

ACC.

DIM.

Curve.

Other

Molded Case Circuit Breaker (BMA Series)

Frame size (AF) (Inm)		630				630				630				800				800				800								
Model		BMA 630-HTD		BMA 630-RTD		BMA 630-HTA		BMA 630-RTA		BMA 630-HED		BMA 630-RED		BMA 800-HTD		BMA 800-RTD		BMA 800-HTA		BMA 800-RTA		BMA 800-HED		BMA 800-RED						
Appearance																														
Rated current In (A) at ambient temp. 40°C		500, 600, 630A				500, 600, 630A				630A				700, 800A				700, 800A				800A								
Number of poles (P)		3	4	3	4	3	4	3	4	3	4	3	4	3	4	3	4	3	4	3	4	3	4	3	4	3	4	3	4	
Rated insulation voltage Ui (V)		AC 1000				1000				1000				1000				1000				1000								
Rated operational voltage Ue(V AC)		690				690				690				690				690				690								
Uimp(kV)		8				8				8				8				8				8								
Dimensions		a	210	280	210	280	210	280	210	280	210	280	210	280	210	280	210	280	210	280	210	280	210	280	210	280	210	280	210	280
		b	275				275				275				275				275				275							
		c	103				103				103				103				103				103							
		ca	155				155				155				155				155				155							
		bb	243				243				243				243				243				243							
		aa	70				70				70				70				70				70							
		(mm)																												
Weight (kg)		10	13	10	13	10	13	10	13	11.5	15.3	11.5	15.3	10	13	10	13	10	13	10	13	10	13	10	13	12	15.8	12	15.8	
Rated breaking capacity (KA)	IEC 60947-2 EN 60947-2 AC lcu	690V	10kA	15kA	10kA	15kA	10kA	15kA	10kA	15kA	10kA	15kA	10kA	15kA	10kA	15kA	10kA	15kA	10kA	15kA	10kA	15kA	10kA	15kA	10kA	15kA	10kA	15kA	10kA	15kA
		415V	50kA	70kA	50kA	70kA	50kA	70kA	50kA	70kA	50kA	70kA	50kA	70kA	50kA	70kA	50kA	70kA	50kA	70kA	50kA	70kA	50kA	70kA	50kA	70kA	50kA	70kA	50kA	70kA
		380V	50kA	70kA	50kA	70kA	50kA	70kA	50kA	70kA	50kA	70kA	50kA	70kA	50kA	70kA	50kA	70kA	50kA	70kA	50kA	70kA	50kA	70kA	50kA	70kA	50kA	70kA	50kA	70kA
		220V(240V)	85kA	100kA	85kA	100kA	85kA	100kA	85kA	100kA	85kA	100kA	85kA	100kA	85kA	100kA	85kA	100kA	85kA	100kA	85kA	100kA	85kA	100kA	85kA	100kA	85kA	100kA	85kA	100kA
Connection		Busbar		Busbar		Busbar		Busbar		Busbar		Busbar		Busbar		Busbar		Busbar		Busbar		Busbar		Busbar		Busbar				
Optional accessories	Alarm switch (AL)	●	●	●	●	●	●	●	●	●	●	●	●	●	●	●	●	●	●	●	●	●	●	●	●	●	●	●	●	
	Auxiliary switch (AX)	●	●	●	●	●	●	●	●	●	●	●	●	●	●	●	●	●	●	●	●	●	●	●	●	●	●	●	●	
	Shunt trip (SHT)	●	●	●	●	●	●	●	●	●	●	●	●	●	●	●	●	●	●	●	●	●	●	●	●	●	●	●	●	
	Under-voltage trip (UVT)	●	●	●	●	●	●	●	●	●	●	●	●	●	●	●	●	●	●	●	●	●	●	●	●	●	●	●	●	
	Rotary handle (EH)	●	●	●	●	●	●	●	●	●	●	●	●	●	●	●	●	●	●	●	●	●	●	●	●	●	●	●	●	
	Terminal cover (TC)	●	●	●	●	●	●	●	●	●	●	●	●	●	●	●	●	●	●	●	●	●	●	●	●	●	●	●	●	
Trip Unit		Fixed Thermal Adjustable Magnetic				Adjustable Thermal Fixed magnetic				Electronic				Fixed Thermal Adjustable Magnetic				Adjustable Thermal Fixed magnetic				Electronic								
Tripping button		Equipped	Equipped	Equipped	Equipped	Equipped	Equipped	Equipped	Equipped	Equipped	Equipped	Equipped	Equipped	Equipped	Equipped	Equipped	Equipped	Equipped	Equipped	Equipped	Equipped	Equipped	Equipped	Equipped	Equipped	Equipped	Equipped	Equipped	Equipped	

Note 1. lcs=100%lcu

Frame size (AF) (Inm)	1000		1250		1600	
Model	BMA 1000-RED	BMA 1000-RED	BMA 1250-RED	BMA 1250-RED	BMA 1600-RED	BMA 1600-RED

Appearance



Rated current In (A) at ambient temp. 40°C	1000A		1250A		1600A	
Number of poles (P)	3	4	3	4	3	4
Rated insulation voltage Ui (V)	AC 1000		1000		1000	
Rated operationa voltage Ue(V AC)	690		690		690	
Uimp(kV)	8		8		8	

Dimensions	(mm)	1000		1250		1600	
		a	b	a	b	a	b
	a	210	280	210	280	210	280
	b	327		327		327	
	c	141		141		141	
	ca	205		205		205	
	bb	200		200		200	
	aa	199	339	199	339	199	339

Weight (kg)	13.3	17.2	13.3	17.2	13.3	17.2	13.3	17.2
-------------	------	------	------	------	------	------	------	------

Rated breaking capacity (kA)	IEC 60947-2 EN 60947-2 AC	1000		1250		1600			
		690V	415V	380V	220V(240V)	690V	415V	380V	220V(240V)
		35	50	50	—	45	70	70	—
		45	70	70	—	45	70	70	—
		—	—	—	—	—	—	—	—

Accessory

AL/AX/SHT/
Rotary handle

Condition:

1. Operation Temp.: -25°C ~ +70 °C
2. Storage Temp.: -40 °C ~ 85 °C
3. Altitude: ≤2000m
4. Pollution class: 3
5. Category: B
6. Relative humidity: ≤ 90%

Neutral Protection:



4P4D: 100% In 3D+N/2: 50% In 4P3D: No protection

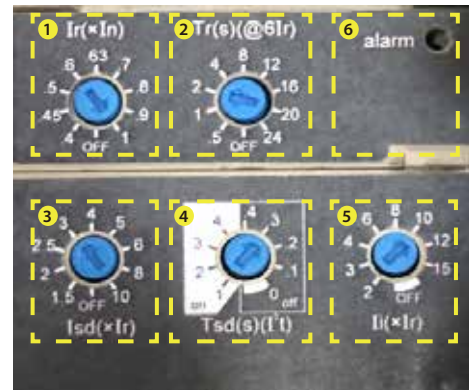



1. Overload Setting Knob
(Ir=0.4/0.45/0.5/0.6/0.63/0.7/0.8/0.9/1/OFF)
2. Overload Tripping Time Setting Knob
(Tr=0.5/1/2/4/8/12/16/20/24/OFF)
3. Instantaneous Setting Knob
(I_{sd}=1.5/2/2.5/3/4/5/6/8/10/OFF)
4. (I_{2t} on: T_{sd}=0.1/0.2/0.3/0.4; I_{2t} off: T_{sd}=0/0.1/0.2/0.3/0.4)
5. Instantaneous Setting Knob
(I_i=2/3/4/6/8/10/12/15/OFF)
6. Alarm indicator: Overload (red light)

Protection



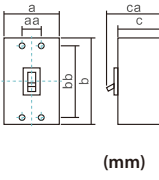

Long-time		Ir=Inx	0.4	0.45	0.5	0.6	0.63	0.7	0.8	0.9	1	OFF
Current setting(A)		Tr (s)	0.5	1	2	4	8	12	16	20	24	OFF
	Time Delay (s)	1.5×Ir	8	16	32	64	128	192	256	320	384	
Accuracy: ±20%		6×Ir	0.5	1	2	4	8	12	16	20	24	
		7.2×Ir	0.35	0.7	1.39	2.78	5.56	8.3	11.1	13.9	16.7	
Short-time		I _{sd} =I _r x	1.5	2	2.5	3	4	5	6	8	10	OFF
Current setting(A)	Accuracy: ±10%	I _t off	0	0.1	0.2	0.3	0.4					
		I _t on		0.1	0.2	0.3	0.4					
Time Delay Tsd(s)												
	Time Delay (ms) at 10×Ir (I _{2t} off or on)	Tsd(Max. resettable time)	20	80	140	230	350					
		Tsd(Max. trip time)	80	140	200	320	500					
Instantaneous		I _i =I _r x	2	3	4	6	8	10	12	15	OFF	
Current setting(A)	Accuracy: ±10%											
Tripping time			60 ±20 ms									

Earth Leakage Circuit Breaker

Frame size (AF) (Inm)		50		100				
Model		BL50-SN		BL100-SN		BL100-HN		
Appearance								
Rated current In (A) at ambient temp. 40°C		15, 20, 30, 40, 50.		15, 20, 30, 40, 50, 60, 75, 100.		15, 20, 30, 40, 50, 60, 75, 100.		
Phase & wire (P)		1ø2W, 3ø3W.	3ø4W	1ø2W, 3ø3W.	3ø4W	1ø2W, 3ø3W.	3ø4W	
Number of poles (P)		3	4	3	4	3	4	
Rated voltage (VAC)		230, 400.		230, 400.		230, 400.		
High speed	Rated current sensitivity I Δ n AC type (mA)	30-100-500mA (adj) *15mA, *30mA, *100mA *100-300-500mA (adj)		30-100-500mA (adj) *15mA, *30mA, *100mA *100-300-500mA (adj)		30-100-500mA (adj) *15mA, *30mA, *100mA *100-300-500mA (adj)		
	Rated current sensitivity I Δ n A type (mA)	30-100-300-500mA(adj)		30-100-300-500mA(adj)		30-100-300-500mA(adj)		
	2I Δ n operating time (S)	0.1		0.1		0.1		
	5I Δ n operating time (S)	0.04		0.04		0.04		
Delay	Rated current sensitivity I Δ n AC type (mA)	100-300-500mA(adj)		100-300-500mA(adj)		100-300-500mA(adj)		
	Rated current sensitivity I Δ n A type (mA)	100-300-500-1000mA(adj)		100-300-500-1000mA(adj)		100-300-500-1000mA(adj)		
	2I Δ n operating time (S)	0.1- 0.4- 0.8- 2.0 adjustable		0.1- 0.4- 0.8- 2.0 adjustable		0.1- 0.4- 0.8- 2.0 adjustable		
	2I Δ n max. non-operating time (S)	0, 0.2, 0.4, 1.0		0, 0.2, 0.4, 1.0		0, 0.2, 0.4, 1.0		
	Leakage detection mode	Mechanical push-button		Mechanical push-button		Mechanical push-button		
Dimensions		a	75	100	90	120	90	120
		b	130		155		155	
		c	68		68		68	
		ca	90		90		90	
		bb	111		132		132	
		aa	25		30		30	
		Weight (kg)	0.7	0.9	1.5	1.8	1.5	1.8
Other	Rated breaking capacity (kA)	IEC 60947-2 EN 60947-2 CNS 14816-2 AC Icu	440V	7.5	10	25		
			380V	7.5	15	30		
			220V	10	25	50		
Connection		Clamp terminal		Clamp terminal		Clamp terminal		
Optional accessories	Alarm switch (AL)	○		○		○		
	Auxiliary switch (AX)	○		○		○		
	Shunt trip (SHT)	○		○		○		
	Under-voltage trip (UVT)	—		○		○		
	Rptary handle (EH)	●		●		●		
	Terminal cover (TC)	●		●		●		
	Leakage alarm module (AM)	—		○		○		
	Box lug (TL)	●		●		●		
Trip Unit		Hydraulic magnetic		Hydraulic magnetic		Hydraulic magnetic		
Tripping button		Equipped		Equipped		Equipped		

Note 1. "●" which can be installed by client, "○" which have to be installed by manufacturer. "—" which is not available.
 2. Specify default rated current sensitivity when place the order.
 3. Ics= 50% Icu
 4. Adjustable thermal: 80%~100% In.
 5. Specify, when order delay type rated current sensitivity 30-100-500mA.

80% ~ 100% Adj. (A)

160		250		400					
BL160-SN		BL250-SN		BL400-SN		BL400-HN		BL400-RN	
									
125, 140, 160.		175, 200, 225, 250.		250, 300, 350, 400.		250, 300, 350, 400.		250, 300, 350, 400.	
1ø2W, 3ø3W.	3ø4W	1ø2W, 3ø3W.	3ø4W	1ø2W, 3ø3W.	3ø4W	1ø2W, 3ø3W.	3ø4W	1ø2W, 3ø3W.	3ø4W
3	4	3	4	3	4	3	4	3	4
230, 400.		230, 400.		230, 400.		230, 400.		230, 400.	
30-100-500mA (adj) *15mA, *30mA, *100mA *100-300-500mA (adj)		30-100-500mA (adj) *15mA, *30mA, *100mA *100-300-500mA (adj)		30-100-500mA (adj) *15mA, *30mA, *100mA *100-300-500mA (adj)		30-100-500mA (adj) *15mA, *30mA, *100mA *100-300-500mA (adj)		30-100-500mA (adj) *15mA, *30mA, *100mA *100-300-500mA (adj)	
30-100-300-500mA(adj)		30-100-300-500mA(adj)		30-100-300-500mA(adj)		30-100-300-500mA(adj)		30-100-300-500mA(adj)	
0.1		0.1		0.1		0.1		0.1	
0.04		0.04		0.04		0.04		0.04	
100-300-500mA(adj)		100-300-500mA(adj)		100-300-500mA(adj)		100-300-500mA(adj)		100-300-500mA(adj)	
100-300-500-1000mA(adj)		100-300-500-1000mA(adj)		100-300-500-1000mA(adj)		100-300-500-1000mA(adj)		100-300-500-1000mA(adj)	
0.1- 0.4- 0.8- 2.0 adjustable		0.1- 0.4- 0.8- 2.0 adjustable		0.1- 0.4- 0.8- 2.0 adjustable		0.1- 0.4- 0.8- 2.0 adjustable		0.45- 1.0- 2.0 adjustable	
0, 0.2, 0.4, 1.0		0, 0.2, 0.4, 1.0		0, 0.2, 0.4, 1.0		0, 0.2, 0.4, 1.0		0.1, 0.5, 1.0	
Mechanical push-button		Mechanical push-button		Mechanical push-button		Mechanical push-button		Mechanical push-button	
105	140	105	140	140	185	140	185	140	185
165		165		257		257		257	
68		68		103		103		103	
92		92		155		155		155	
126		126		194		194		194	
35		35		44		44		44	
1.7	2.3	1.7	2.3	6.6	8.4	6.6	8.4	5.7	7.5
25		25		30		42		55	
30		30		35		50		70	
50		50		50		85		100	
Clamp terminal		Clamp terminal		Busbar		Busbar		Busbar	
●		●		●		●		●	
●		●		●		●		●	
●		●		●		●		●	
●		●		●		●		●	
●		●		●		●		●	
●		●		●		●		●	
○		○		○		○		○	
●		●		●		●		●	
Adj. thermal Fixed magnetic		Adj. thermal Fixed magnetic		Thermal magnetic		Thermal magnetic		Thermal magnetic	
Equipped		Equipped		Equipped		Equipped		Equipped	

BM

Series

BL

Series



ACC.

DIM.

Curve.

Other

Earth Leakage Circuit Breaker

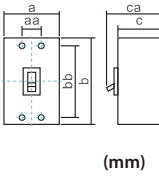
Frame size (AF) (Inm)		400		630				
Model		BL400-UN		BL630-HN		BL630-RN		
Appearance								
Rated current In (A) at ambient temp. 40°C		250, 300, 350, 400.		500, 630.		500, 630.		
Phase & wire (P)		1ø2W, 3ø3W.	3ø4W	1ø2W, 3ø3W.	3ø4W	1ø2W, 3ø3W.	3ø4W	
Number of poles (P)		3	4	3	4	3	4	
Rated voltage (VAC)		230, 400.		230, 400.		230, 400.		
High speed	Rated current sensitivity I Δ n AC type (mA)	30-100-500mA (adj) *15mA, *30mA, *100mA *100-300-500mA (adj)		100-300-500mA (adj)		100-300-500mA (adj)		
	Rated current sensitivity I Δ n A type (mA)	30-100-300-500mA(adj)		100-300-500-1000mA(adj)		100-300-500-1000mA(adj)		
	2I Δ n operating time (S)	0.1		0.1		0.1		
	5I Δ n operating time (S)	0.04		0.04		0.04		
Delay	Rated current sensitivity I Δ n AC type (mA)	100-300-500mA(adj)		100-300-500mA(adj)		100-300-500mA(adj)		
	Rated current sensitivity I Δ n A type (mA)	100-300-500-1000mA(adj)		100-300-500-1000mA(adj)		100-300-500-1000mA(adj)		
	2I Δ n operating time (S)	0.45- 1.0- 2.0 adjustable		0.45- 1.0- 2.0 adjustable		0.45- 1.0- 2.0 adjustable		
	2I Δ n max. non-operating time (S)	0.1, 0.5, 1.0		0.1, 0.5, 1.0		0.1, 0.5, 1.0		
	Leakage detection mode	Mechanical push-button		Mechanical push-button		Mechanical push-button		
Dimensions		a	140	185	210	280	210	280
		b	257		257		257	
		c	103		103		103	
		ca	155		155		155	
		bb	194		243		243	
		aa	44		70		70	
		(mm)						
Weight (kg)		5.7	7.5	10.0	13.0	10.0	13.0	
Rated breaking capacity (kA)	IEC 60947-2 EN 60947-2 CNS 14816-2	AC	440V	85	50	70		
			380V	85	50	70		
			Icu	220V	125	85	100	
Connection		Busbar		Busbar		Busbar		
Optional accessories	Alarm switch (AL)	●		●		●		
	Auxiliary switch (AX)	●		●		●		
	Shunt trip (SHT)	●		●		●		
	Under-voltage trip (UVT)	●		●		●		
	Rotary handle (EH)	●		●		●		
	Terminal cover (TC)	●		●		●		
	Leakage alarm module (AM)	○		○		○		
	Box lug (TL)	●		●		●		
Trip Unit		Thermal magnetic		Fixed thermal Adj. magnetic		Fixed thermal Adj. magnetic		
Tripping button		Equipped		Equipped		Equipped		

Note 1. "●" which can be installed by client, "○" which have to be installed by manufacturer. "—" which is not available.
 2. Specify default rated current sensitivity when place the order.
 3. Ics= 50% Icu
 4. Adjustable thermal: 80%~100% In.
 5. Specify, when order delay type rated current sensitivity 30-100-500mA.

BM

Series

BL

Series

ACC.

DIM.

Curve.

Other

BM

Series

BL





Series

ACC.

DIM.

Curve.

Other

630		800		630		800	
BL630-UN		BL800-SN		BL800-HN		BL800-RN	
							
500, 630.		700, 800.		700, 800.		700, 800.	
1ø2W, 3ø3W.	3ø4W	1ø2W, 3ø3W.	3ø4W	1ø2W, 3ø3W.	3ø4W	1ø2W, 3ø3W.	3ø4W
3	4	3	4	3	4	3	4
230, 400.		230, 400.		230, 400.		230, 400.	
100-300-500mA (adj)		100-300-500mA (adj)		100-300-500mA (adj)		100-300-500mA (adj)	
100-300-500-1000mA (adj)		100-300-500-1000mA (adj)		100-300-500-1000mA (adj)		100-300-500-1000mA (adj)	
0.1		0.1		0.1		0.1	
0.04		0.04		0.04		0.04	
100-300-500mA(adj)		100-300-500mA(adj)		100-300-500mA(adj)		100-300-500mA(adj)	
100-300-500-1000mA(adj)		100-300-500-1000mA(adj)		100-300-500-1000mA(adj)		100-300-500-1000mA(adj)	
0.45- 1.0- 2.0 adjustable		0.45- 1.0- 2.0 adjustable		0.45- 1.0- 2.0 adjustable		0.45- 1.0- 2.0 adjustable	
0.1, 0.5, 1.0		0.1, 0.5, 1.0		0.1, 0.5, 1.0		0.1, 0.5, 1.0	
Mechanical push-button		Mechanical push-button		Mechanical push-button		Mechanical push-button	
210	280	210	280	210	280	210	280
257		257		257		257	
103		103		103		103	
155		155		155		155	
243		243		243		243	
70		70		70		70	
10.0	13.0	10.5	13.5	10.5	13.5	10.5	13.5
85		50		70		85	
100		50		70		100	
125		85		100		125	
Busbar		Busbar		Busbar		Busbar	
●		●		●		●	
●		●		●		●	
●		●		●		●	
●		●		●		●	
●		●		●		●	
●		●		●		●	
○		○		○		○	
●		●		●		●	
Fixed thermal Adj. magnetic		Fixed thermal Adj. magnetic		Fixed thermal Adj. magnetic		Fixed thermal Adj. magnetic	
Equipped		Equipped		Equipped		Equipped	

Optional Accessories Installation Table

■ AL: Alarm Switch / AX: Auxiliary Switch / SHT: Shunt Trip / UVT: Under Voltage Trip

Model	Poles	AL	AX	SHT or UVT	AL+AX	AL+ SHT or UVT	AX+ SHT or UVT	AL+AX+ SHT or UVT		
BM30-SN BM50-CN BM60-SN/HN BM63-SN/HN BM100-SN/MN	3P							—		
BL50-SN	3P 4P									—
BL100-SN BL100-HN	3P 4P				—			—		
BM100-HS BM160-HS BM250-HS	3P 4P							—		
BM100-BTD/STD/LTD BM125-LTD/HTA/RTA BM160-SN/HN/HTA/RTA BM250-SN/HN/HTA/RTA BMA125-ST/LTA/HTA BMA160-ST/LTA/HTA BMA250-ST/LTA/HTA	3P 4P									
BL160-SN BL250-SN/ CN	3P 4P				—	—	—	—		
BM400-SN/HN/CN/RN/UN BMA400-LTA/HTA/RTA BM630s-STD/LTD/HTD/RTD BM630s-ST/LTA/HTA/RTA BMA630s-STD/LTD/HTD/RTD BMA630s-ST/LTA/HTA/RTA	3P 4P									
BL400-SN/HN/RN/UN	3P 4P							—		
BM630-SN/HN/CN/RN/UN BM800-CN/SN/HN/RN BMA630-HTD/RTD/HTA/ RTA/HED/RED BMA800-HTD/RTD/HTA/ RTA/HED/RED	3P 4P									
BL630-HN/RN/UN BL800-SN/HN/RN	3P 4P									
BM1000-HS BM1200-HS BM1600-HS	3P				—			—		

2P, 125Af and below : Accessories are installed on the right side.

Note:

- Standard: AL and AX are installed on left side, SHT and UVT are installed on right side.
- SHT is equipped with coil anti-burn switch.
- BL series can not do right side installation.
- UVT of BM30-SN~BM100-HN can not install on its left side.
- #1 means have no UVT.
- #2 means only can apply to 4P breakers.

● : AL
○ : AX
■ : SHT or UVT

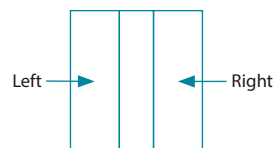

Optional Accessories | Application Table

Rotary Handle

TYPE	Poles	Model
EH-100N	3P~4P	BM30-SN, BM50-CN, BM60-SN/HN, BM63-SN/HN, BM100-SN/MN, BL50-SN
EH-100T	3P~4P	BM100-BTD/STD
EH-100L	3P~4P	BM100-LTD, BM125-LTD
EH-125T	2P~3P~4P	BM125-HTA/RTA
EH-125N	3P~4P	BM60-HBN, BM100-HN, BM125-SN/HN, BL100-SN/HN, BMA125-STA/LTA/HTA
EH-250N	3P~4P	BM160-SN*/HN, BM250-CN*/SN/HN, BL160-SN, BL250-SN
EH-250T	3P~4P	BM160-HTA/RTA, BMA160-STA/LTA/HTA, BM250-HTA/RTA, BMA250-STA/LTA/HTA
EH-400N	3P~4P	BM400-CN*/SN/HN/RN/UN, BL400-SN/HN/RN/UN, BMA400-LTA/HTA/RTA BM630s-STD/LTD/LTD/HTD/RTD/STA/LTA/HTA/RTA, BMA630s-STD/LTD/LTD/HTD/RTD/STA/LTA/HTA/RTA
EH-800N	3P~4P	BM630-SN/HN/RN/UN, BM800-CN/SN/HN/RN, BL630-HN/RN/UN, BL800-SN/HN/RN, BMA630-HTD/RTD/HTA/RTA/HED/RED, BMA800-HTD/RTD/HTA/RTA/HED/RED
EH-250H	3P~4P	BM100-HS, BM160-HS, BM250-HS

Note: * indicates the value is can applied to 2P model.

Extended Rotary Handle

TYPE	Poles	Model
MA-100N	3P~4P	BM30-SN, BM50-CN, BM60-SN/HN, BM63-SN/HN, BM100-SN/MN, BL50-SN
MA-100T	3P~4P	BM100-BTD/STD
MA-100L	3P~4P	BM100-LTD, BM125-LTD
MA-125T	2P~3P~4P	BM125-HTA/RTA, BMA125-STA/LTA
MA-125N	3P~4P	BM60-HBN, BM100-HN, BM125-SN/HN, BL100-SN/HN, BMA125-STA/LTA/HTA
MA-250N	3P~4P	BM160-SN/HN, BM250-SN/HN, BMA125-STA/LTA/HTA, BMA250-STA/LTA/HTA, BL160-SN, BL250-SN
MA-250T	3P~4P	BM160-HTA/RTA, BMA160-STA/LTA/HTA, BM250-HTA/RTA, BMA250-STA/LTA/HTA
MA-400N	3P~4P	BM400-SN/HN/RN/UN, BL400-SN/HN/RN/UN, BMA400-LTA/HTA/RTA BM630s-STD/LTD/LTD/HTD/RTD/STA/LTA/HTA/RTA, BMA630s-STD/LTD/LTD/HTD/RTD/STA/LTA/HTA/RTA
MA-800N	3P~4P	BM630-SN/HN/RN/UN, BM800-CN/SN/HN/RN, BL630-HN/RN/UN, BL800-SN/HN/RN, BMA630-HTD/RTD/HTA/RTA/HED/RED, BMA800-HTD/RTD/HTA/RTA/HED/RED
MA-250H	3P~4P	BM100-HS, BM160-HS, BM250-HS

Terminal Cover

TYPE	Pole	Long cover	Short cover	Model
TC-30N	2	TC30CN2P	—	BM30-CN
	3	TC30CN3P	—	
TC-100N	2	TC100N2P-K	TCS100N2P-K	BM30-SN, BM50-CN, BM60/63-SN/HN BM100-HN/SN, BL50-SN BM100-BTD/STD BM100/125-LTD
	3	TC100N3P-K	TCS100N3P-K	
	4	TC100N4P-K	TCS100N4P-K	
TC-125N	2	TC125N2P-K	TCS125N2P-K	BM60-HBN BM100-HN, BM125-SN/HN BL100-SN/HN
	3	TC125N3P-K	TCS125N3P-K	
	4	TC125N4P	TCS125N4P	
TC-125A	2~3	TC125A3P-K	TCS125A3P-K	BM125-HTA/RTA BMA125-STA/LTA/HTA
	4	TC125A4P-K	TCS125A4P-K	
TC-250N	3	TC250N3P-K	—	BM160-SN/HN, BM250-CN/SN/HN BM160/250-HTA/RTA BMA160/250-STA/LTA/HTA BL160-SN, BL250-SN
	4	TC250N4P-K	—	
TC-250H	3	TC250H3P	—	BM100-HS BM160/250-HS
TC-400N	3	TC400N3P	—	BM400-CN/SN/HN/RN/UN BM630s-STD/LTD/LTD/HTD/RTD BM630s-STA/LTA/HTA/RTA BMA400-LTA/HTA/RTA BMA400-HTD/RTD/HMF/RMF BMA630s-STD/LTD/LTD/HTD/RTD BMA630s-STA/LTA/HTA/RTA BL400-SN/HN/RN/UN
	4	TC400N4P	—	
TC-630N	3	TC630N3P	—	BM630-CN/SN/HN/UN/RN BM800-CN/SN/HN/RN BM630-HE/RE/UE, BM800-SE/HE/RE BMA630-HTD/RTD/HTA/RTA BMA800-HTD/RTD/HTA/RTA BMA630-HED/RED BMA800-HED/RED BL630-HN/RN/UN, BL800-SN/HN/RN
	4	TC630N4P	—	

Motor Operation Device

TYPE	Poles	Model
MT-100N	3P~4P	BM30-SN, BM50-CN, BM60-SN/HN, BM63-SN/HN, BM100-SN/MN, BL50-SN
MT-125N	3P~4P	BM60-HBN, BM100-HN, BM125-SN/HN, BL100-SN/HN, BMA125-STA/LTA/RTA
MT-250N	3P~4P	BM160-SN/HN, BM250-SN/HN, BL160-SN, BL250-SN, BMA160-STA/LTA/HTA, BMA250-STA/LTA/HTA
MT-400N	3P~4P	BM400-SN/HN/RN/UN, BL400-SN/HN/RN/UN, BMA400-LTA/HTA/RTA BM630s-STD/LTD/LTD/HTD/RTD/STA/LTA/HTA/RTA BMA630s-STD/LTD/LTD/HTD/RTD/STA/LTA/HTA/RTA
MT-800N	3P~4P	BM630-SN/HN/RN/UN, BM800-CN/SN/HN/RN, BL630-HN/RN/UN, BL800-SN/HN/RN, BMA630-HTD/RTD/HTA/RTA/HED/RED, BMA800-HTD/RTD/HTA/RTA/HED/RED
MT-250E	3P~4P	BM100-HS, BM160-HS, BM250-HS

Note: Applicable voltage : ① DC 24V ② AC 110V/ DC 110V ③ AC 230V/ DC 220V

Rear Connection

TYPE	Poles	Model
PGI-100N50	3P	BM30-SN, BM50-CN, BM60-SN/HN, BM63-SN/HN, BL50-SN (50A and below), BM50-CN
PGI-100N	3P	BM60-SN/HN, BM100-SN/MN (60A and below)
PGI-125N50	3P	BM60-HBN, BM100-HN, BM125-SN/HN, BL100-SN/HN (50A and below)
	4P	BM100-HN, BM125-SN, BL100-SN/HN (50A and below)
PGI-125M	2P~3P~4P	BM125-HTA/RTA
PGI-125N	3P	BM60-HBN, BM100-HN, BM125-SN, BL100-SN/HN (60A and above)
	4P	BM100-HN, BM125-SN, BL100-SN/HN (60A and above)
PGI-250N	3P~4P	BM160-SN/HN, BM160-HTA/RTA, BM250-SN/HN, BM250-HTA/RTA, BL160-SN, BL250-SN
PGI-400N	3P~4P	BM400-SN/HN/RN/UN, BL400-SN/HN/RN/UN, BM630s-STD/LTD/HTD/RTD/STA/LTA/HTA/RTA, BMA630s-STD/LTD/HTD/RTD/STA/LTA/HTA/RTA
PGI-800N	3P~4P	BM630-SN/HN/RN/UN, BM800-CN/SN/HN/RN, BL630-HN/RN/UN, BL800-SN/HN/RN
PGI-BM250	3P	BM100-HS, BM160-HS, BM250-HS

Locking Device

TYPE	Poles	Model
FHL-250M	2P~3P~4P	BM125-HTA/RTA, BMA125-STA/ LTA/ HTA
	3P~4P	BM160/250- HN / HTA / RTA / SN , BM250 CN, BMA160/250-STA/LTA/HTA, *BL160/250-SN
FHL-400M	3P~4P	BM400-CN/SN/HN/RN/UN, BM400-HE/RE/UE, BMA400-LTA/HTA/RTA, BMA630s-STD/STA/LTD/LTA/HTD/HTA/RTD/RTA, BM630s-STD/STA/LTD/LTA/HTD/HTA/RTD/RTA
FHL-800M	3P~4P	BM630-SN/HN/RN/UN, BM800-CN/SN/HN/RN, BM630-HE/RE/UE, BM800-SE/HE/RE, BMA630-HED/RED, BMA800-HED/RED, BMA630/800- HTD/RTD

Box Lug

Model	Rated Current	Applicable Breaker	
		MCCB	ELCB
TL-100N	50A	BM30-SN, BM50-CN, BM60-SN*, BM60-HN*, BM63-SN*, BM63-HN*, BM100-SN*	BL50-SN
TL-125N	50A	BM60-HBN*, BM100-HN*, BM125-SN*, BM125-HN*	BL100-SN*, BL100-HN*
	125A	BM60-SN**, BM60-HN**, BM63-SN**, BM63-HN**, BM60-HBN**, BM100-MN**, BM100-SN**, BM100-HN**, BM125-SN**, BM125-HN**	BL100-SN**, BL100-HN**
TL-250N	250A	BM160-SN, BM160-HN, BM250-CN, BM250-SN, BM250-HN	BL160-SN, BL250-SN
TL-250H	50A	BM100-HS*	—
	100A	BM100-HS**, BM100-HE, BM100-RE, BM100-UE	—
	250A	BM160-HS, BM250-HS, BM160-HE, BM160-RE, BM160-UE, BM250-HE, BM250-RE, BM250-UE	—
TL-400N	400A	BM400-CN, BM400-SN, BM400-HN, BM400-RN, BM400-UN, BM400-HE, BM400-RE, BM400-UE	BL400-SN, BL400-HN BL400-RN, BL400UN
TL-800N	800A	BM630-CN, BM630-SN, BM630-HN, BM630-RN, BM630-UN, BM630-HE, BM630-RE, BM630-UE	BL630-HN, BL630-RN, BL630-UN
		BM800-CN, BM800-SN, BM800-HN, BM800-RN, BM800-SE, BM800-HE, BM800-RE	BL800-SN, BL800-HN BL800-RN
TL-1200H	1200A	BM1000-HS, BM1200-HS, BM1000-SE, BM1000-HE, BM1250-SE, BM1250-HE	—
TL-1600H	1600A	BM1600-HS	—

Torque Table

Model	Rated Current	Screw "A" torque			Screw "A" torque			Applicable wire		Length(mm)	
		N · m	kgf · cm	lb · in	N · m	kgf · cm	lb · in	ISO	AWG / MCM	L1	L2
TL-100N	50A	2~3	20~30	17.5~26.5	2*~3	20*~30	17*~27	2.5~16 mm ²	14 AWG~6 AWG	14	—
TL-125N	50A	3.9~4.9	40~50	35~43.5							
	TL-250N	125A	4.9~6.9	50~70	43.5~61	6	61	53	10~50 mm ²	8 AWG~1 AWG	21
50A		4.9~6.9	50~70	43.5~61	2*~3	20*~30	17*~27	2.5~16 mm ²	14 AWG~6 AWG		
100A					6	61	53	10~50 mm ²	8 AWG~1 AWG		
250A	15				153	133	50~120 mm ²	1 AWG~250 AWG			
TL-250H	50A	4.9~6.9	50~70	43.5~61	2*~3	20*~30	17*~27	2.5~16 mm ²	14 AWG~6 AWG	21	—
	100A				6	61	53	10~50 mm ²	8 AWG~1 AWG		
	250A				15	153	133	50~120 mm ²	1 AWG~250 AWG		
TL-400N	400A	40~50	400~500	350~440	31	316	275	120~240 mm ²	250 AWG~500 AWG	30	—
TL-800N	800A										
TL-1200H	1200A										
TL-1600H	1600A										

BM100-BTD/STD

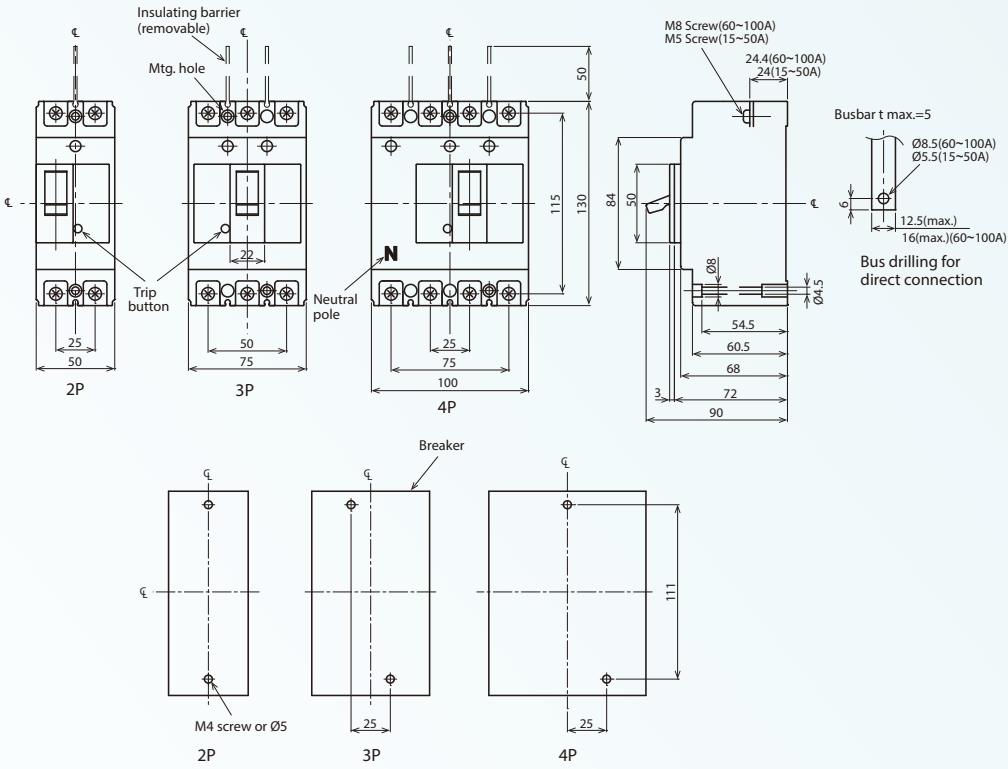

Panel cut

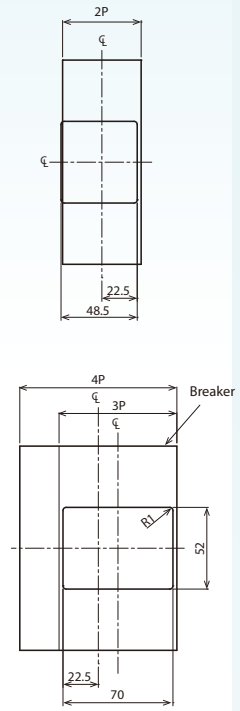

BM

Series

BL

Series

ACC.

BM100-LTD, BM125-LTD

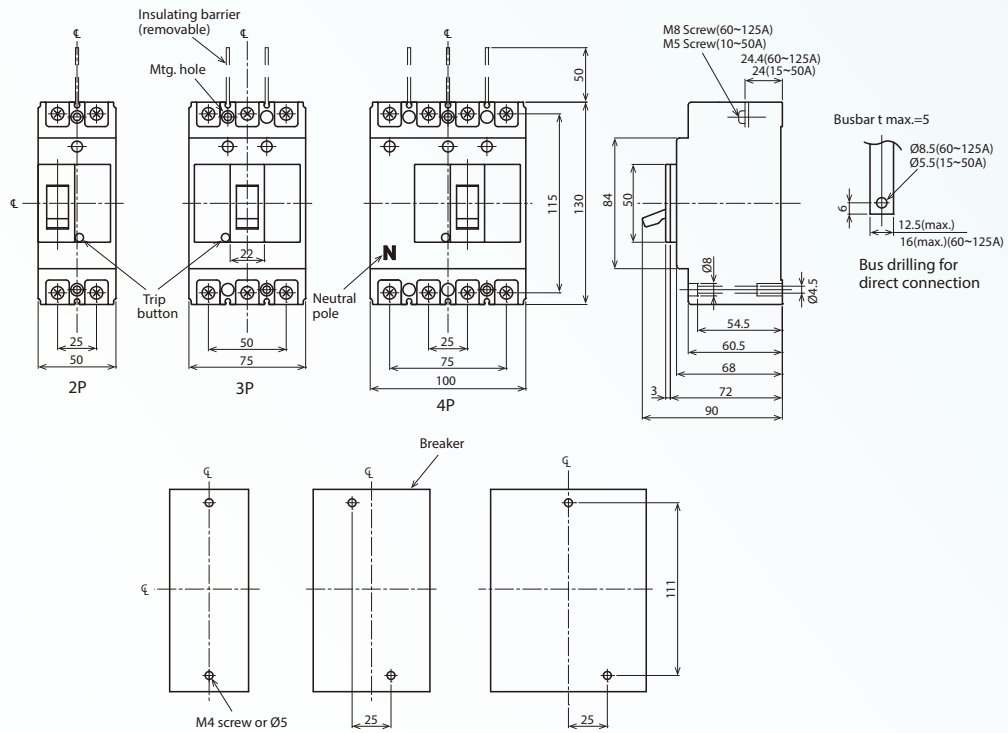

Panel cut

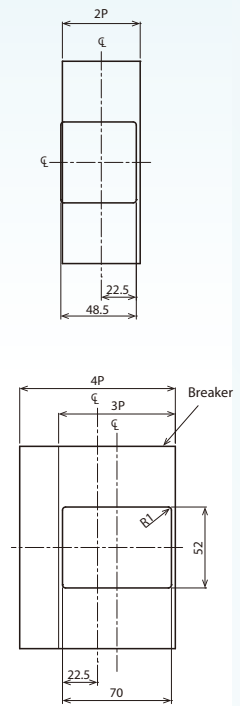

DIM.

Curve.

Other

BM125-HTA/RTA

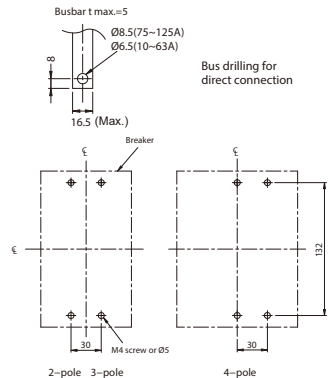
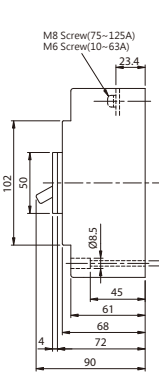
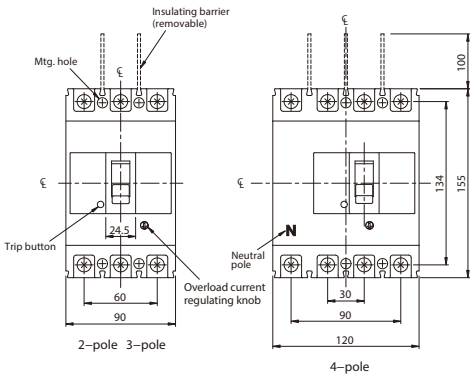

Panel cut

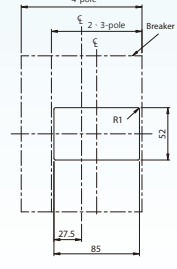

BM100-HS, BM160-HS, BM250-HS

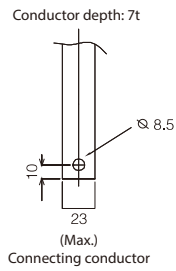
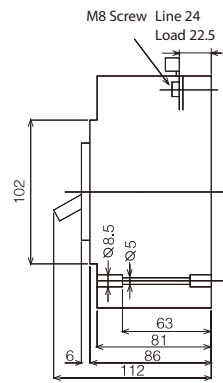
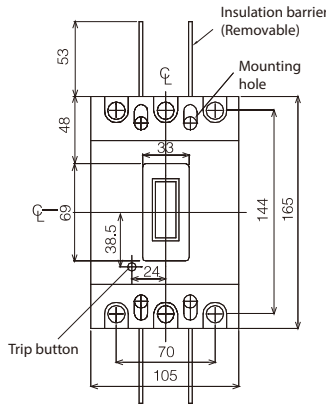

Panel cut

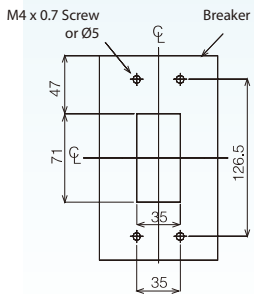

BM160-SN/HN, BM250-SN/HN

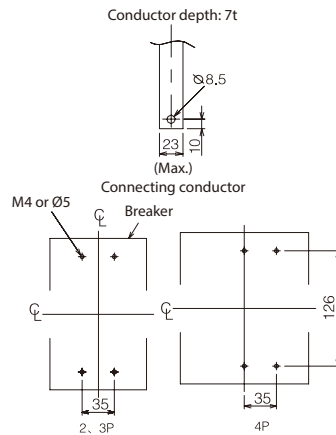
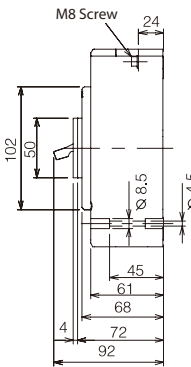
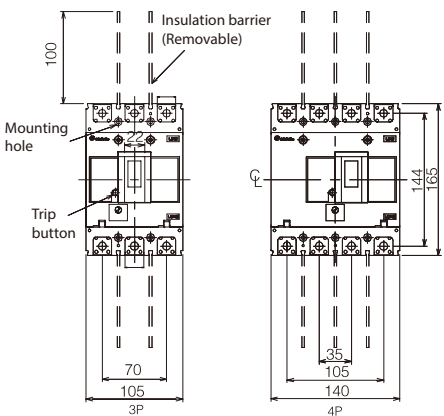

Panel cut

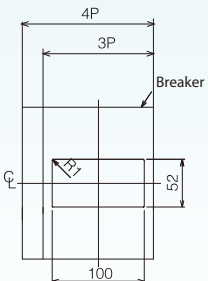

Dimension of circuit breaker

BM160/250-HTA/RTA

Panel cut

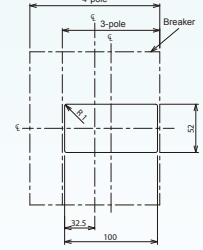
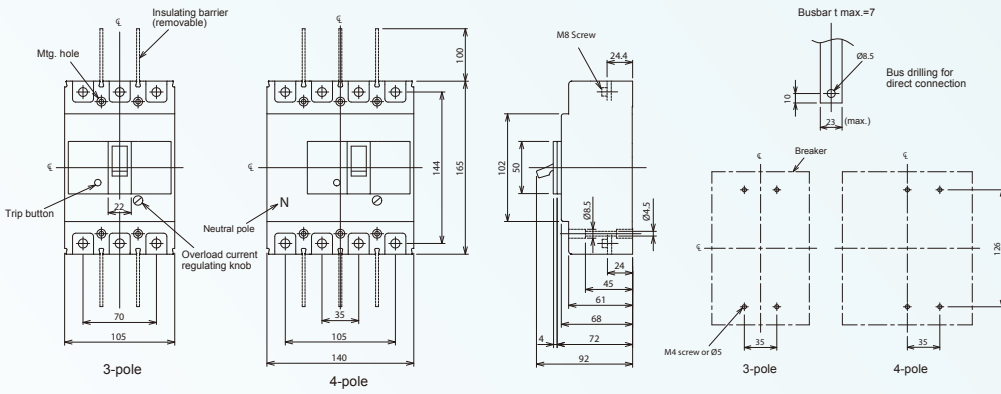

BM

Series

BM100-FTD

Panel cut

BL

Series

ACC.

DIM.

Curve.

Other

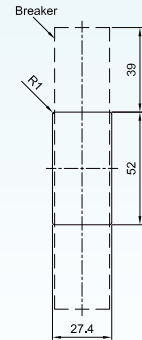
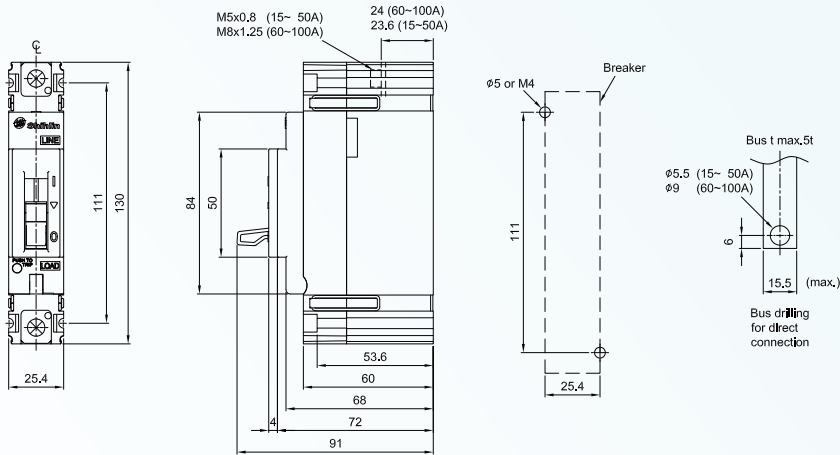

BM400-SN/HN/RN/UN

Nameplate Panel cut

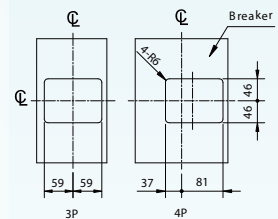
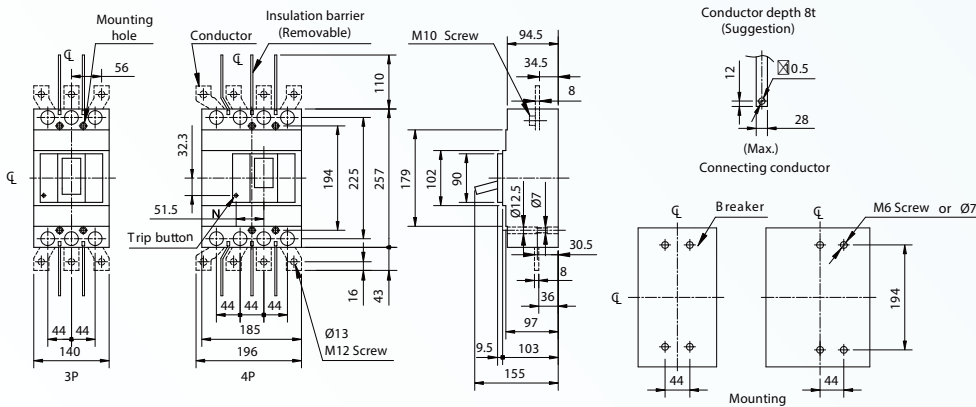

Handle Panel cut

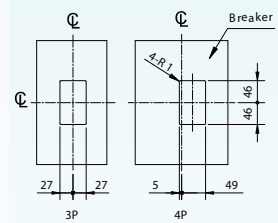

BM630s-STD/LTD/HTD/RTD/STA/LTA/HTA/RTA

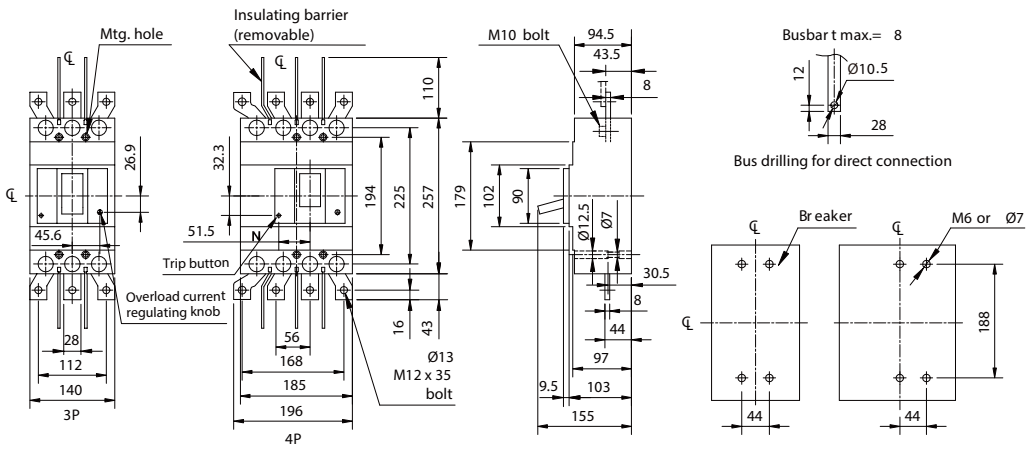

Panel cut

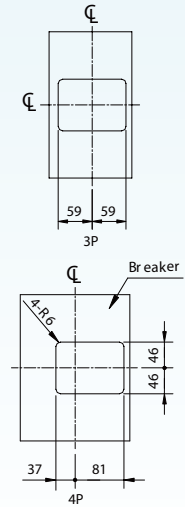

BM630-SN/HN/RN/UN

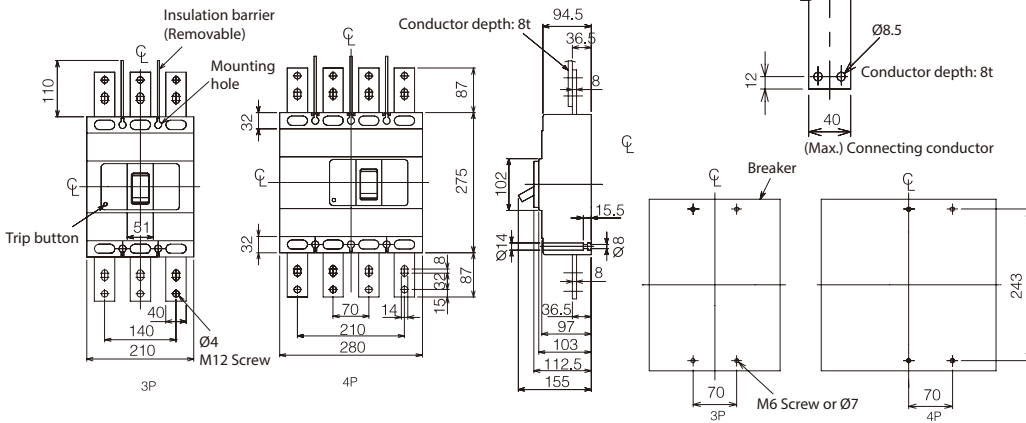

Panel cut

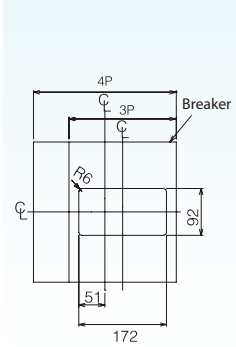

BM800-CN/SN/HN/RN

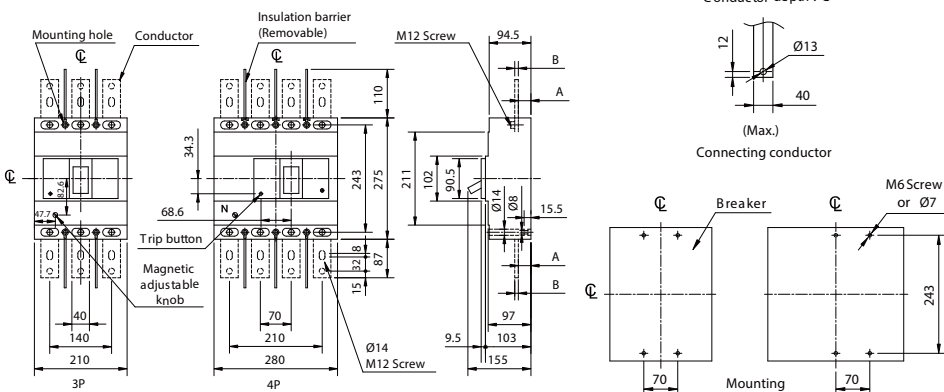

Nameplate Panel cut

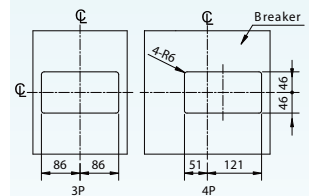

Handle Panel cut

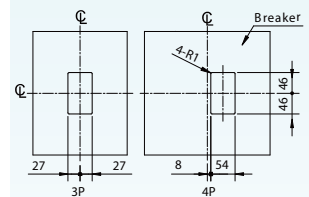

Model	A-value	B-value	C-value
BM630-AF	28.5	8	8
BM800-AF	28.5	10	10

DIMENSION

BM

Series

BL

Series

ACC.

DIM.

Curve.

Other

Dimension of circuit breaker

BM1000-HS, BM1200-HS

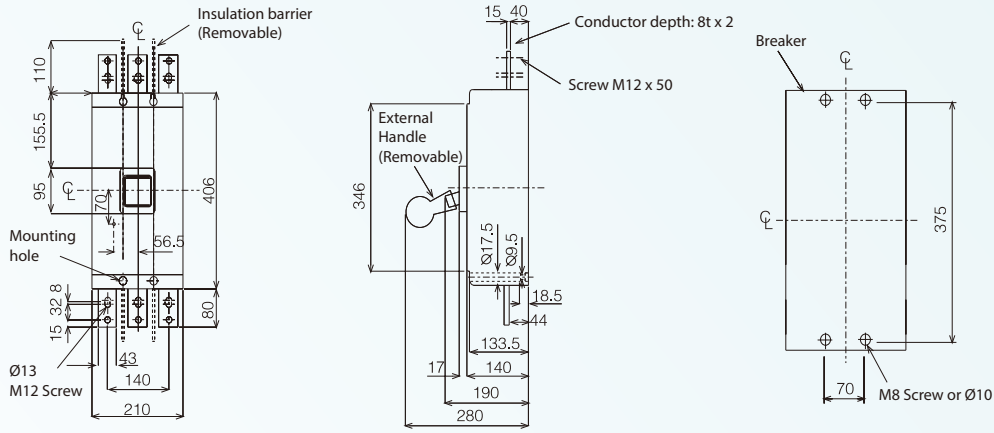

Panel cut

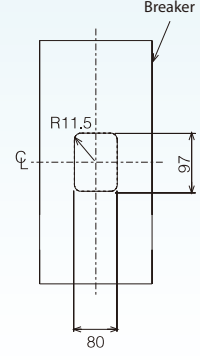

BM

Series

BL

Series

ACC.

DIM.

Curve.

Other

BM1600-HS

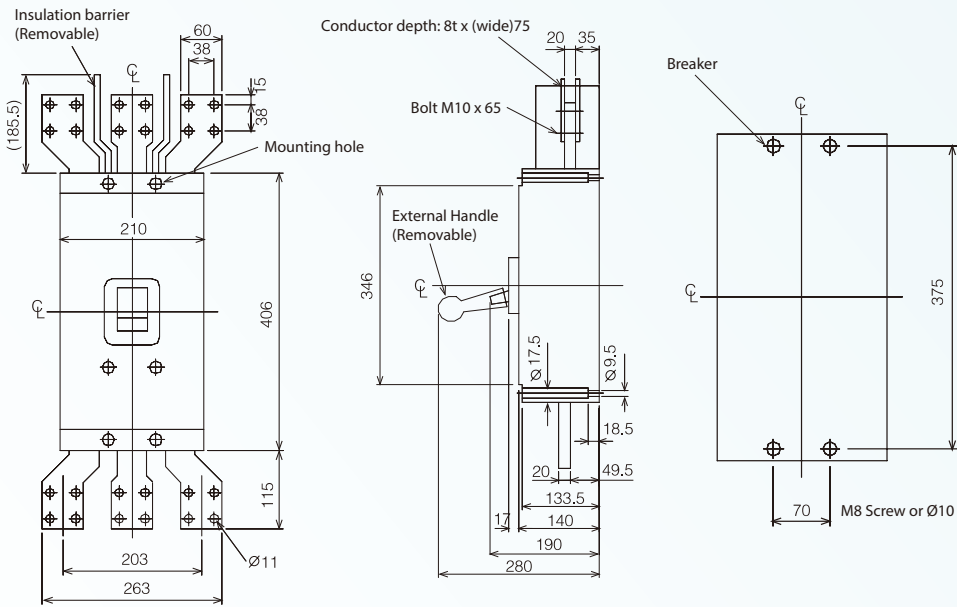

Panel cut

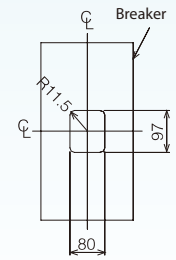

BL50-SN

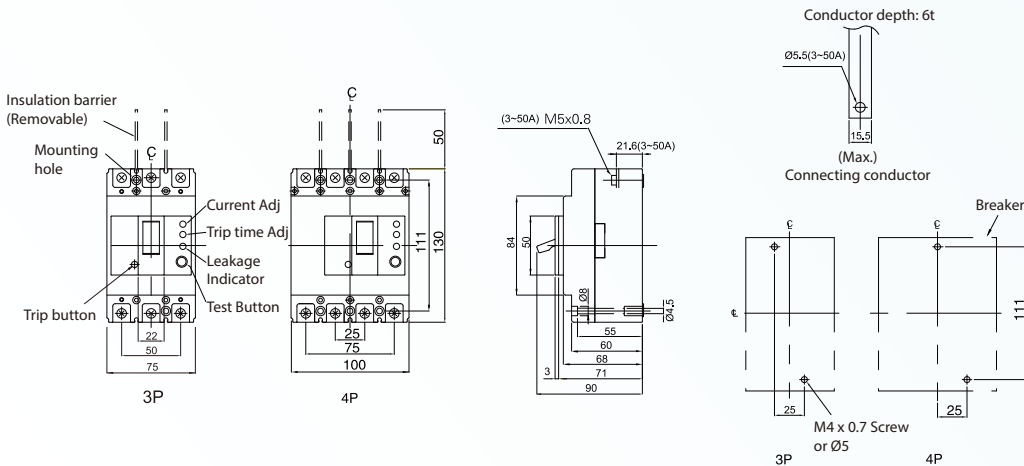

Panel cut

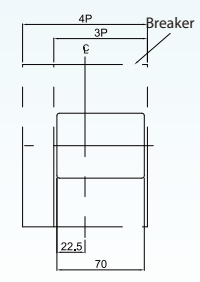

BL100-SN/HN

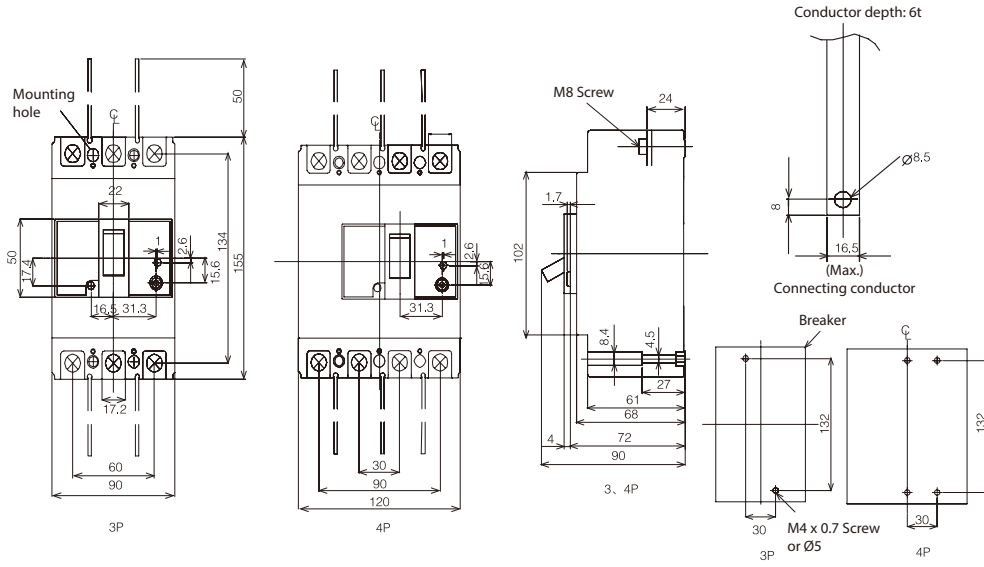

Panel cut

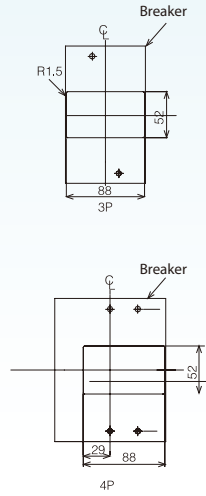

BL160-SN, BL250-SN

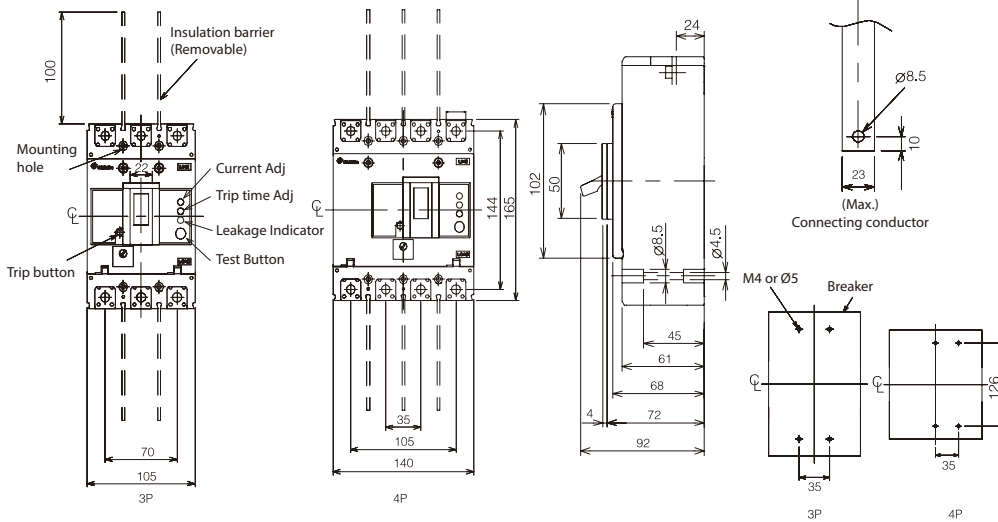

Panel cut

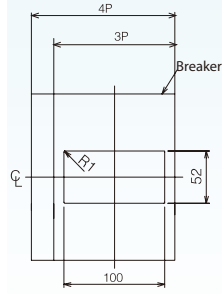

BL400-SN/HN/RN/UN

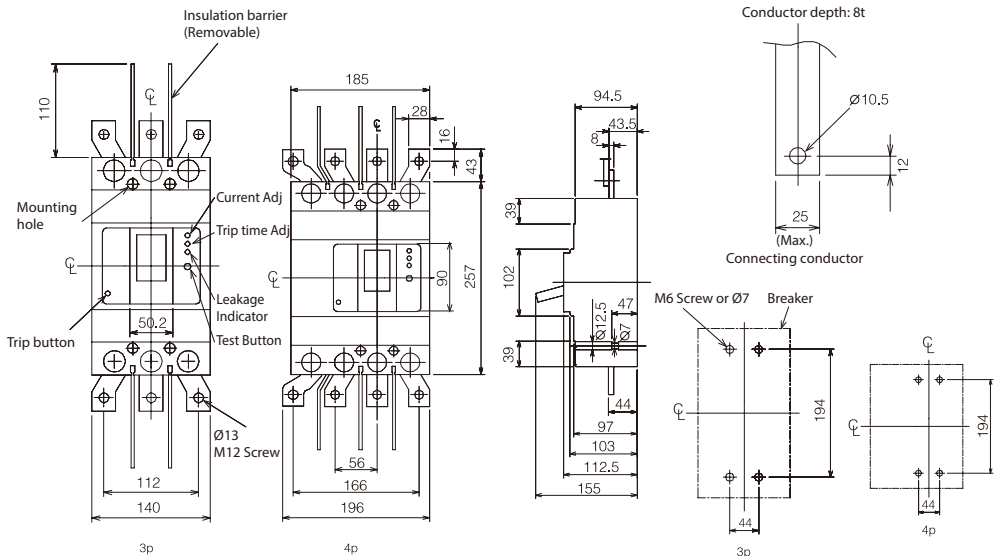

Panel cut

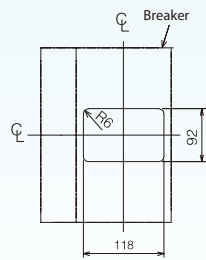

Dimension of circuit breaker

BL630-HN/RN/UN

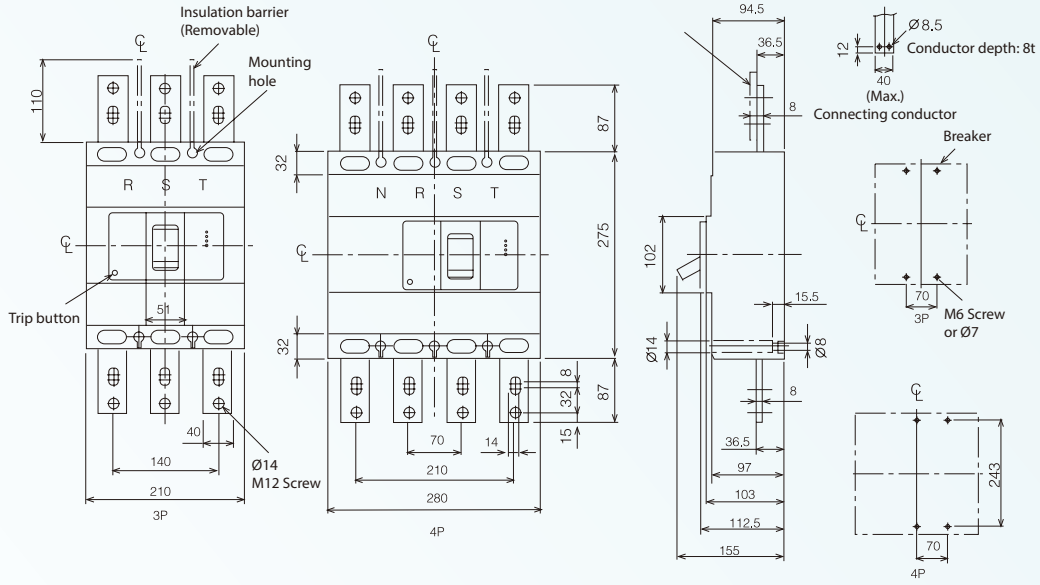

Panel cut

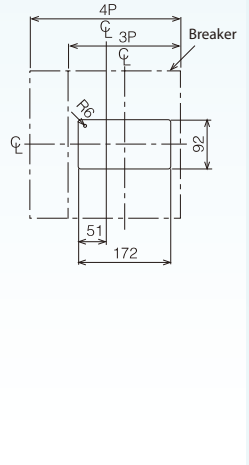

BM

Series

BL

Series

ACC.

DIM.

Curve.

Other

BL800-SN/HN/RN

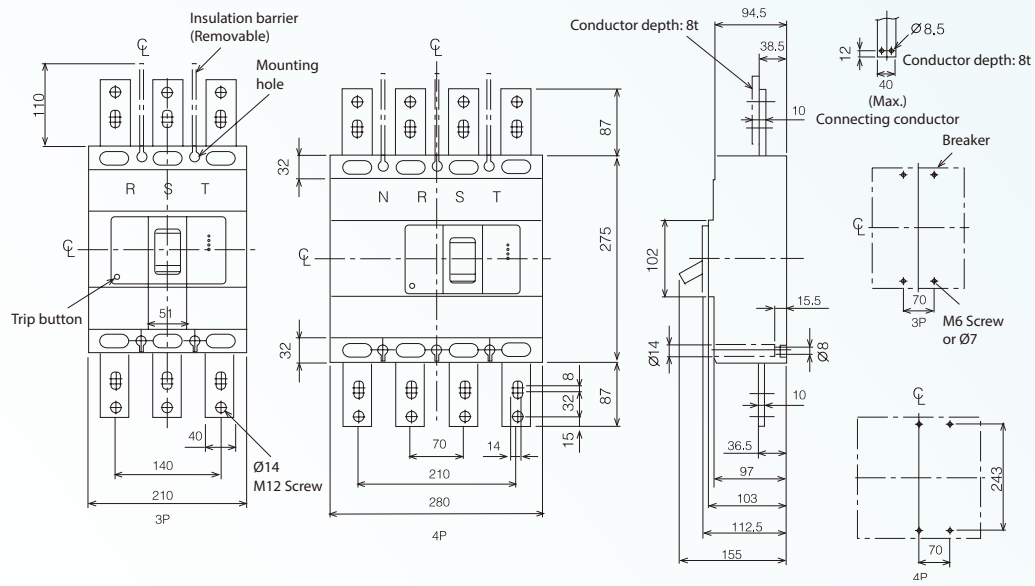

Panel cut

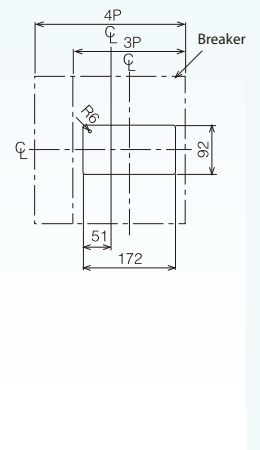

Dimension of circuit breaker

BMA125-STA/LTA/HTA

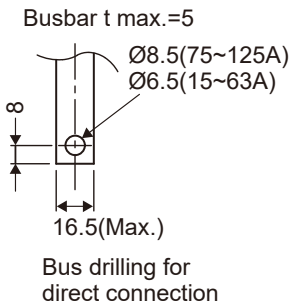
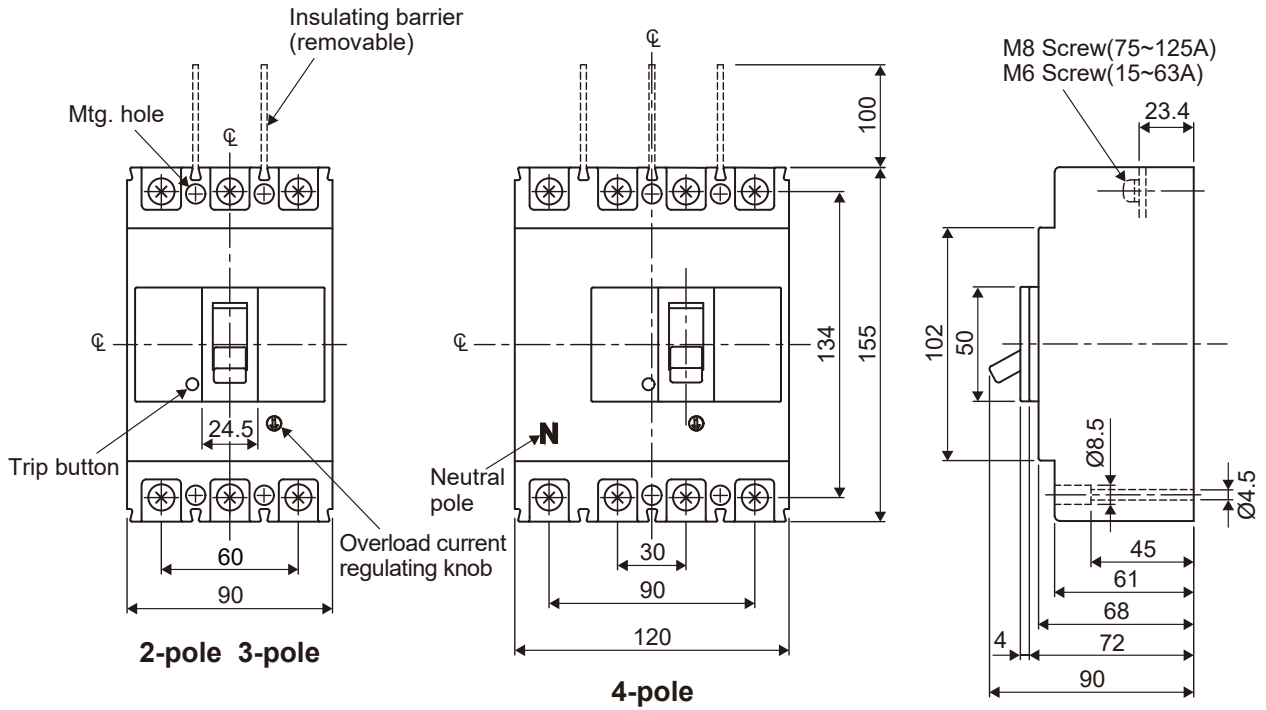

Mounting

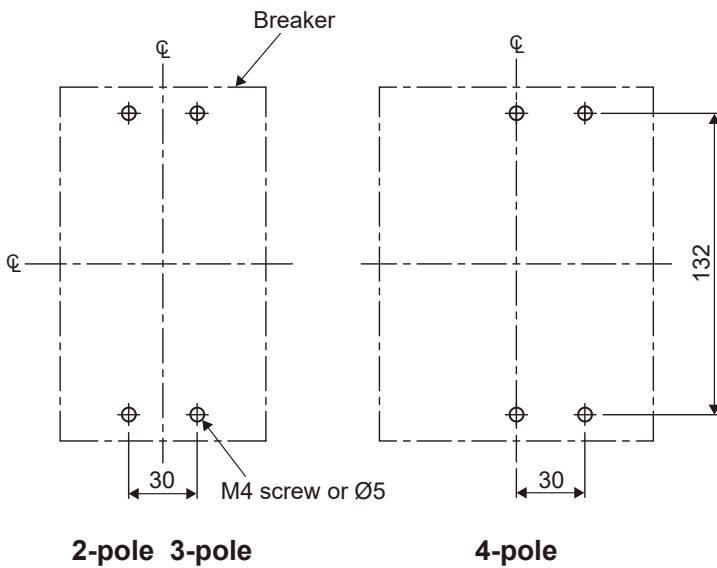

Panel cut

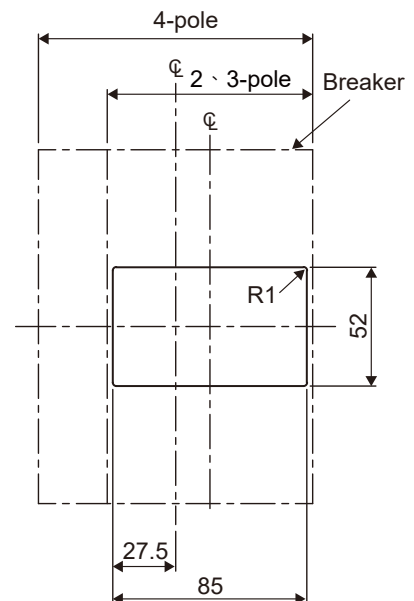

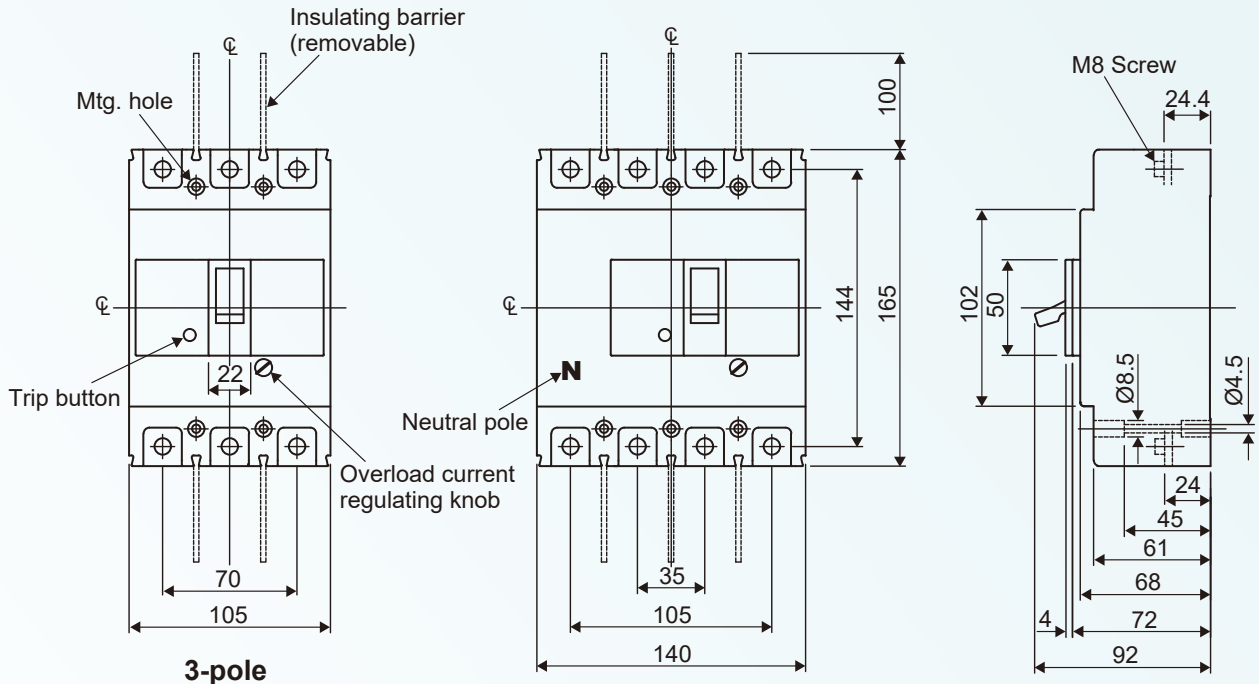

Busbar t max.=7

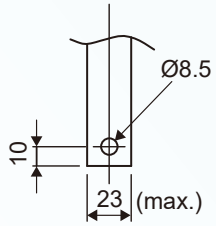

Bus drilling for direct connection

Mounting

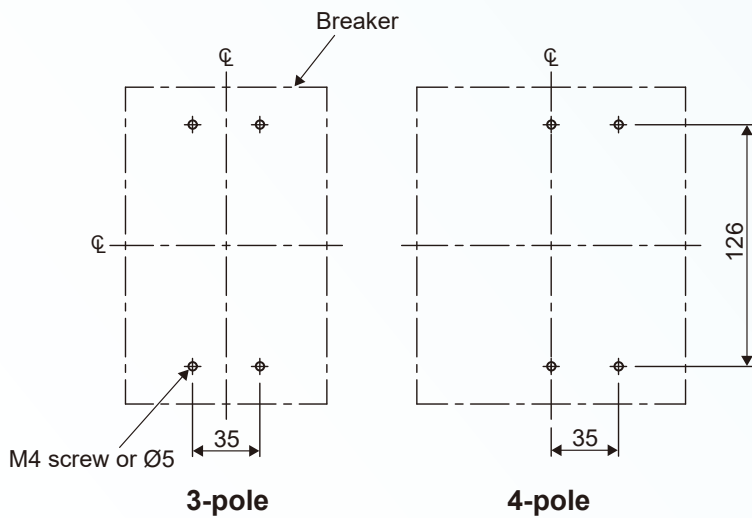

Panel cut

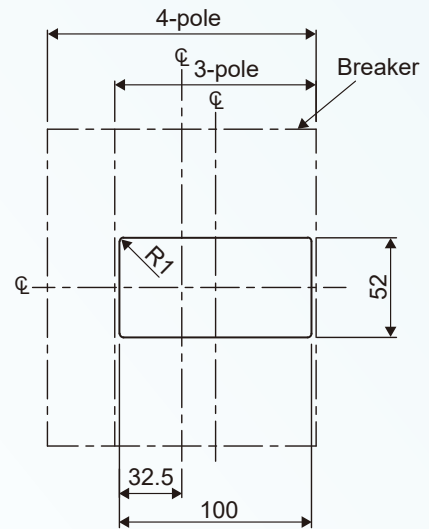

BM

Series

BL

Series

ACC.

DIM.

Curve.

Other

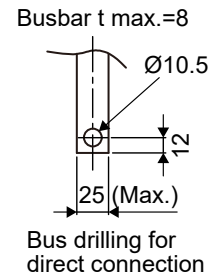
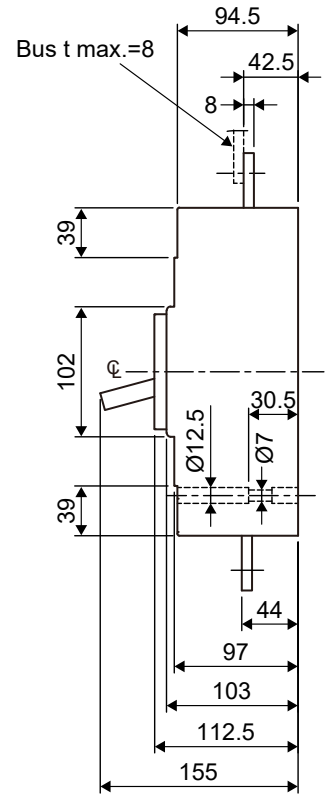
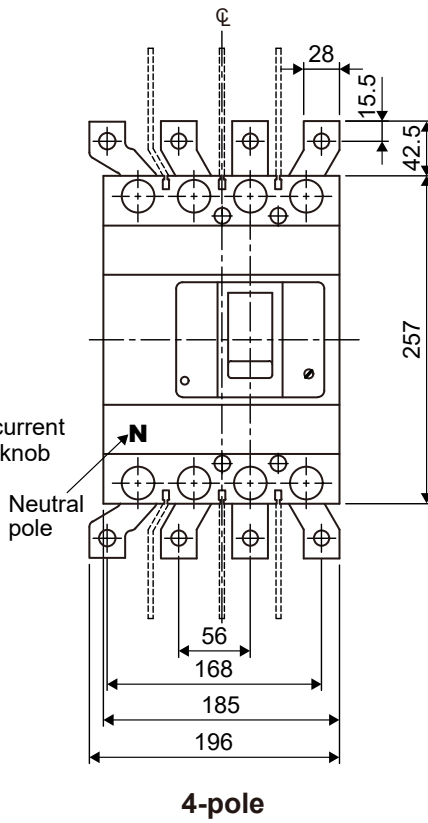
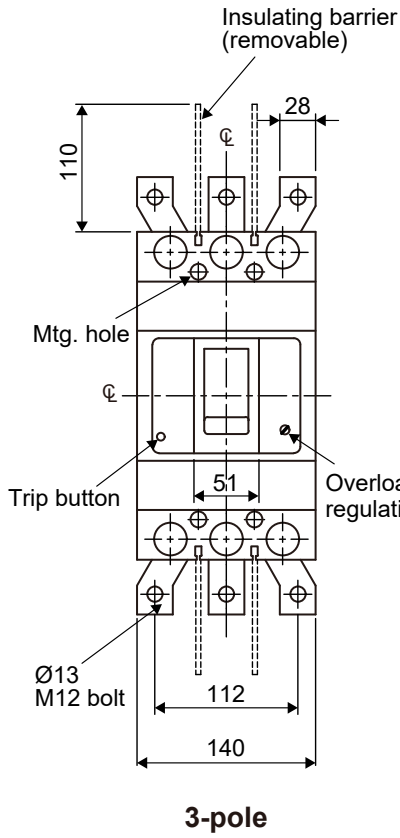

Mounting

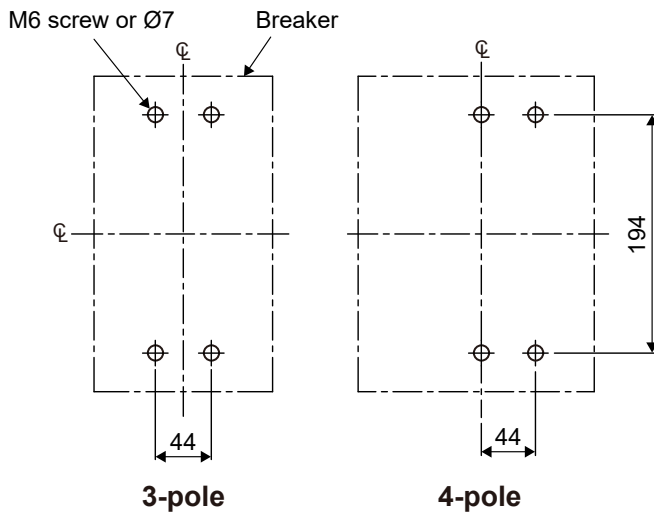

Panel cut

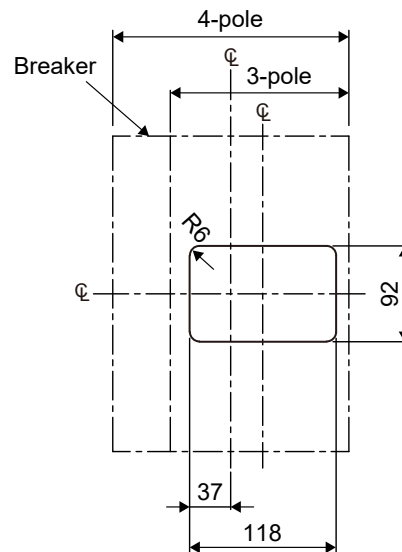

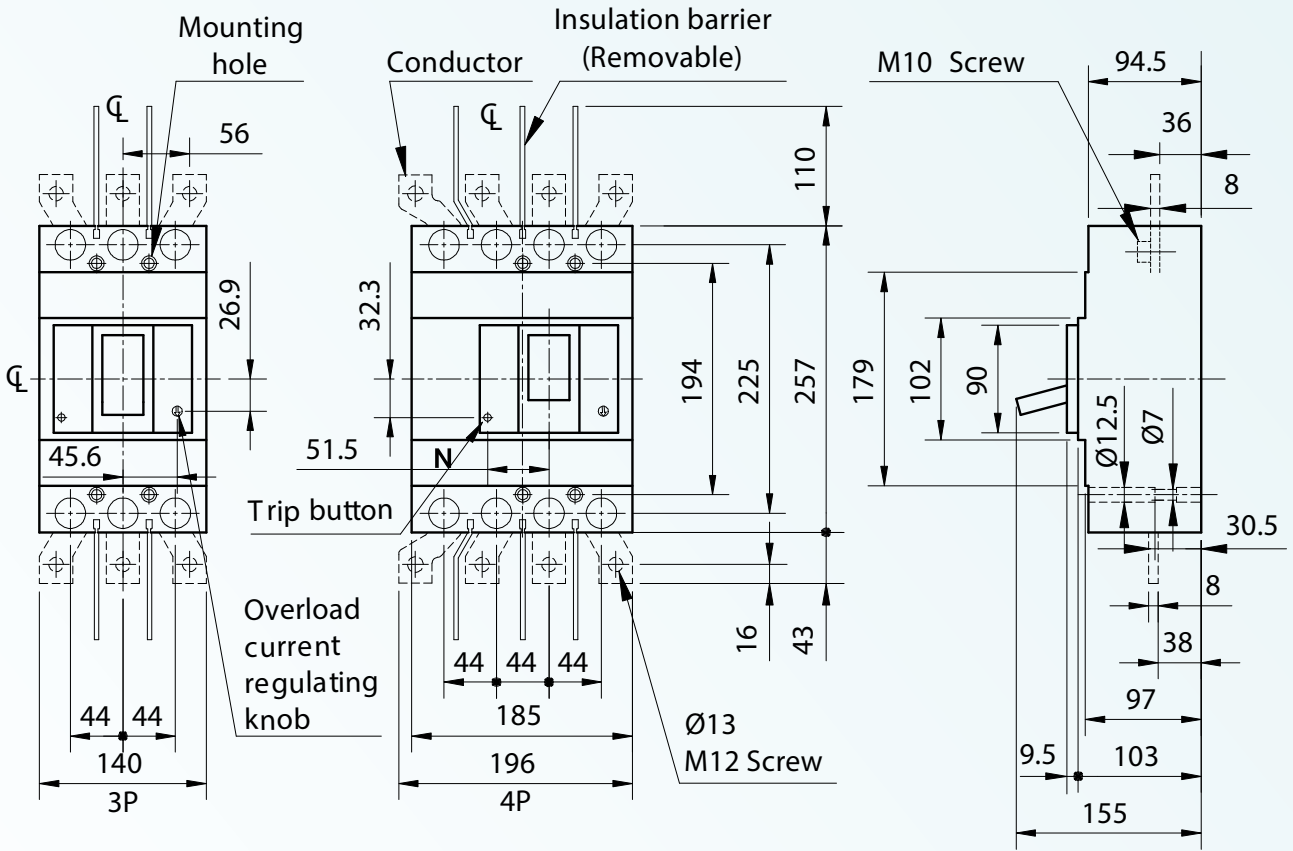

Conductor depth 8t (Suggestion)

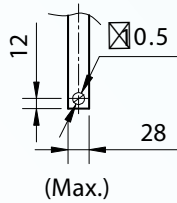

Connecting conductor

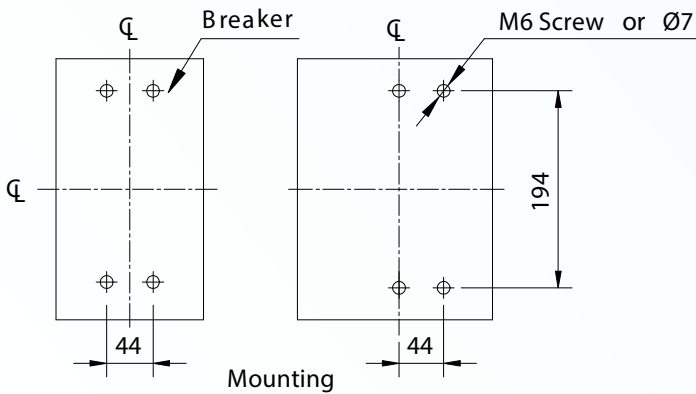

Nameplate Panel Cut

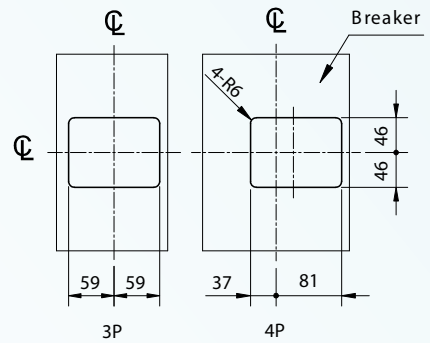

Handle Panel Cut

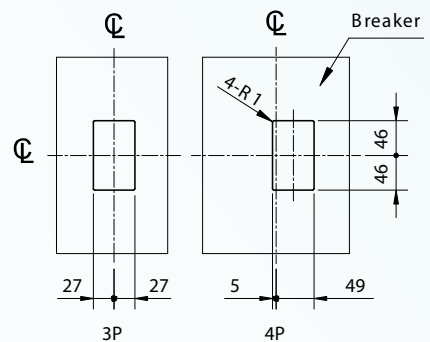

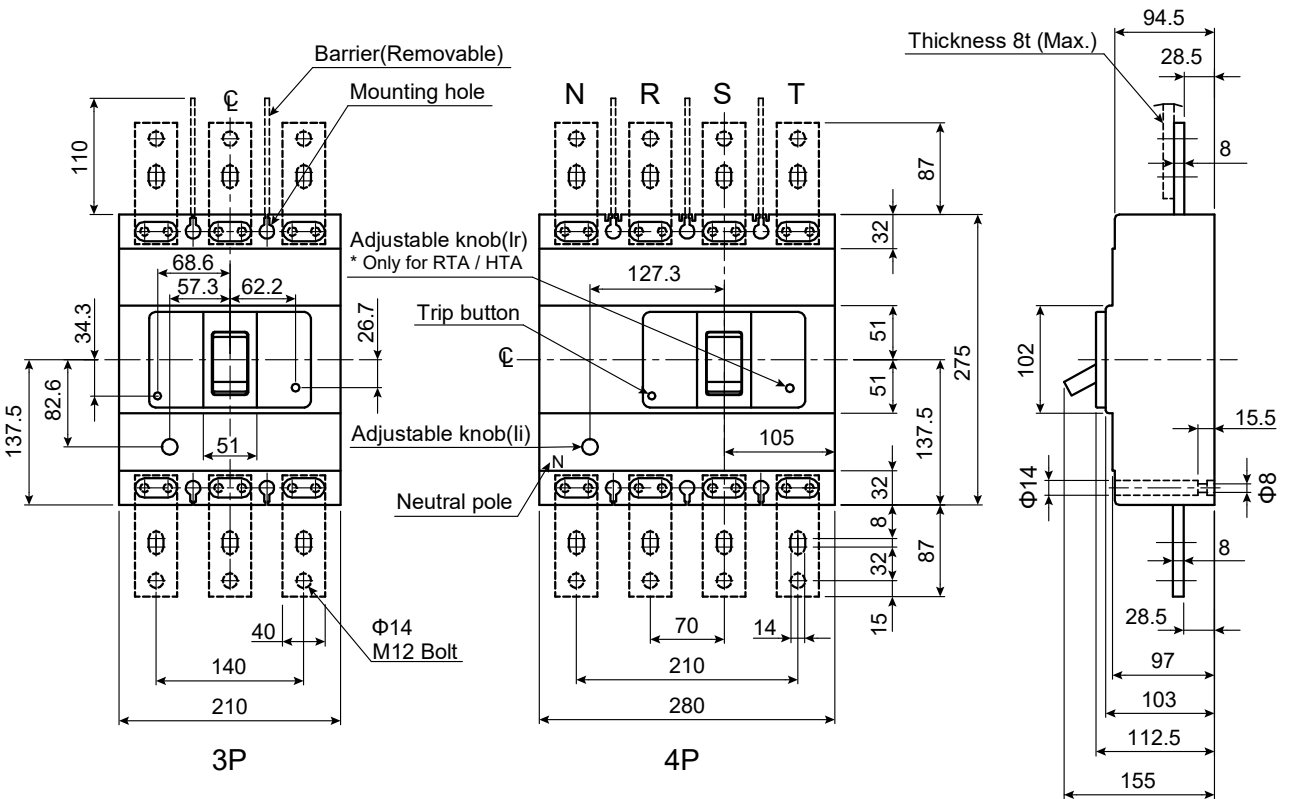

Mounting

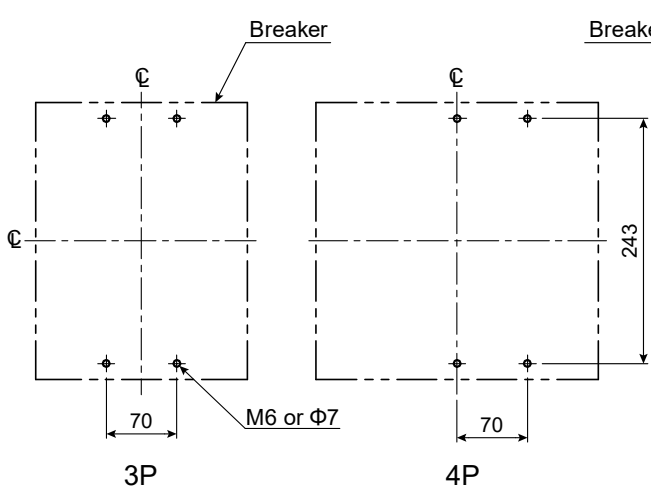

Panel cut

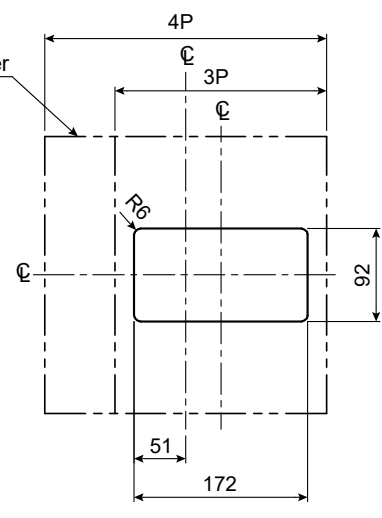

Conductor

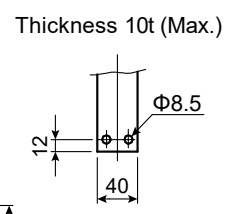

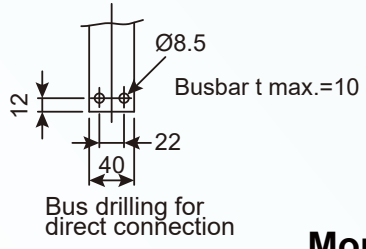
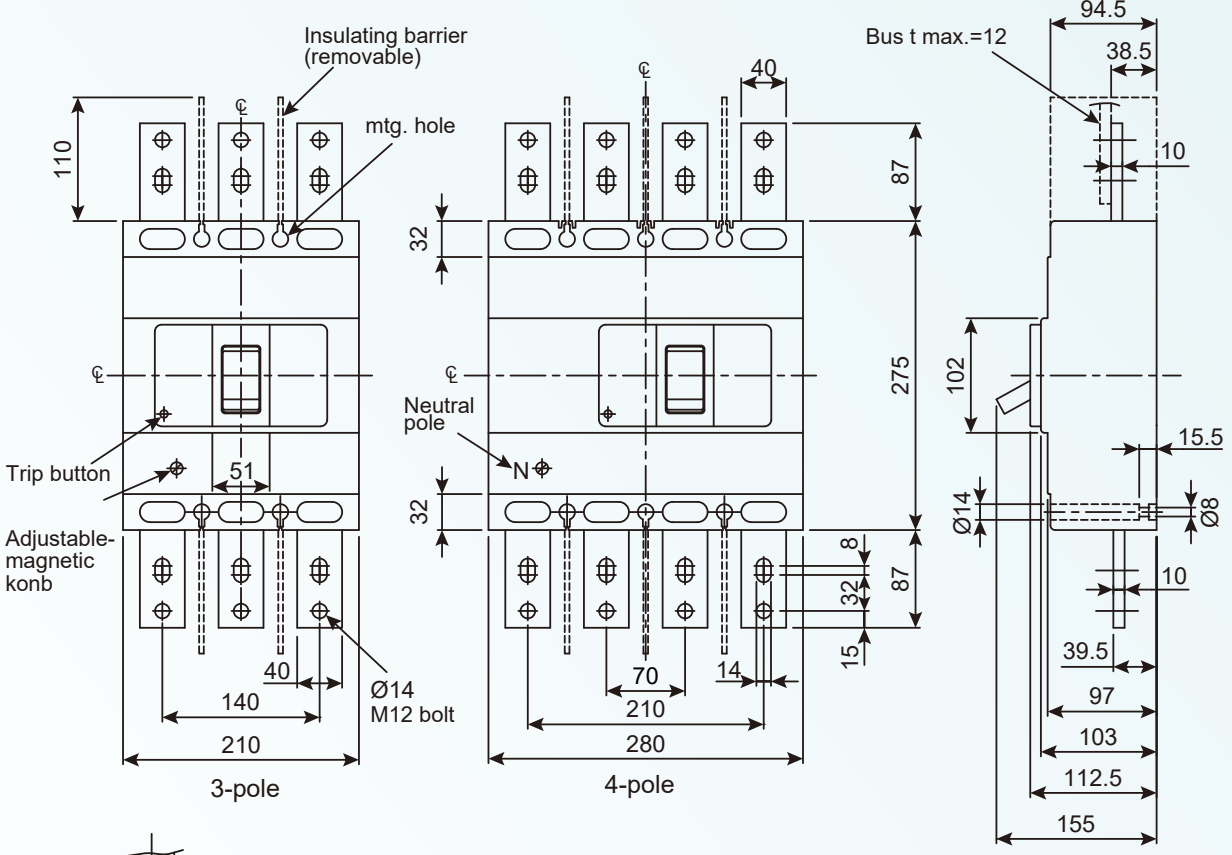

- BM Series
- BL Series
- ACC.
- DIM.
- Curve.
- Other

Mounting

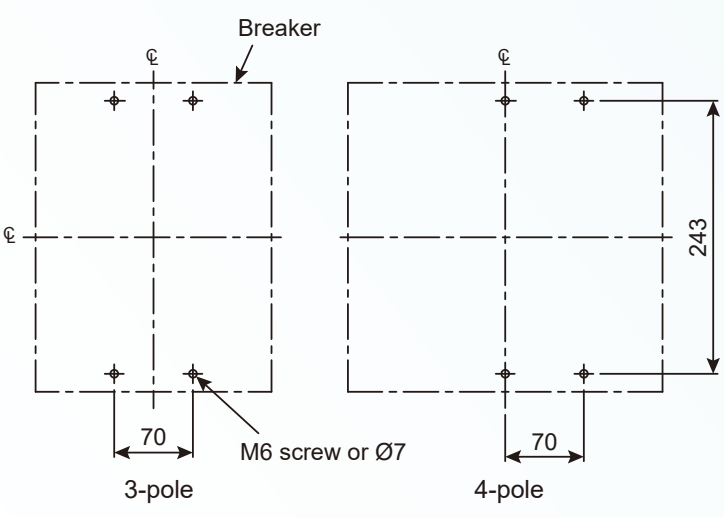

Panel Cut

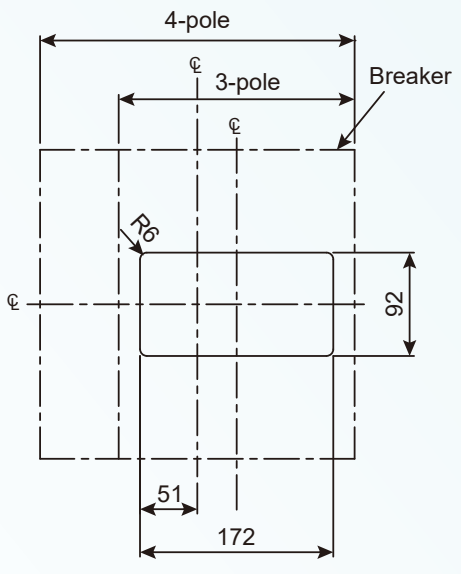

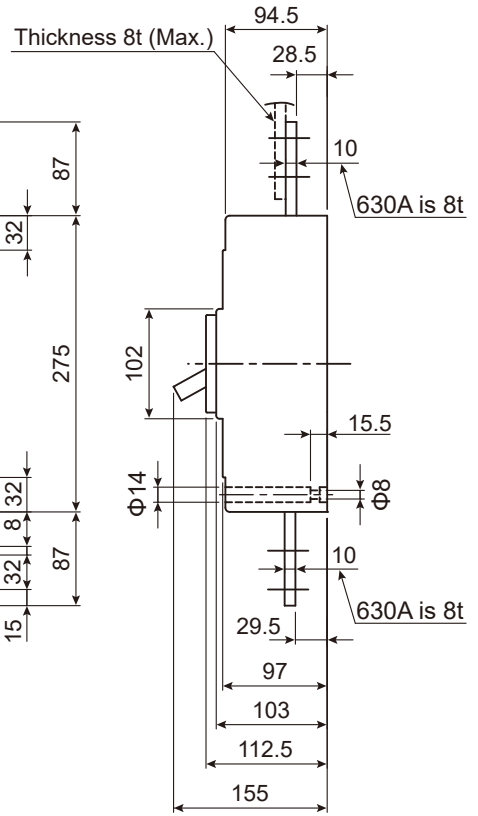
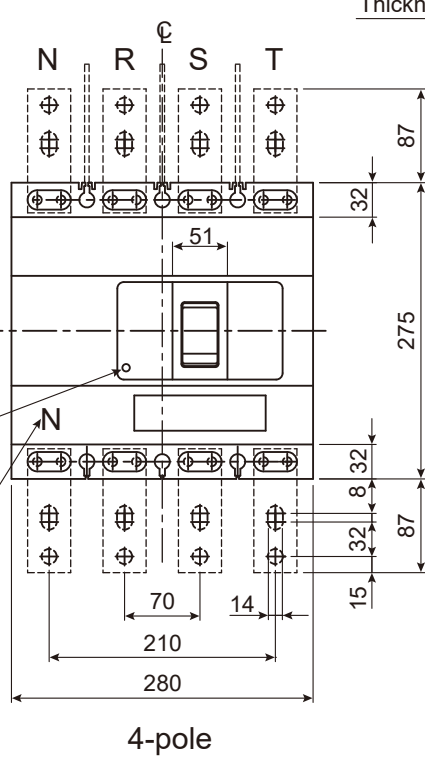
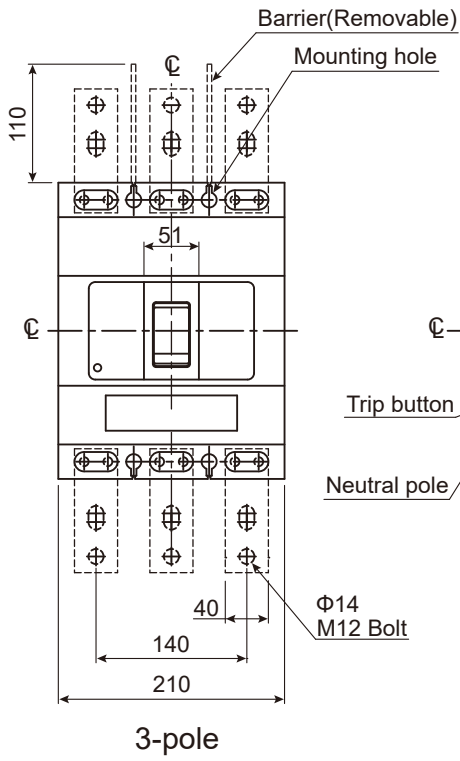

Thickness 10t (Max.)

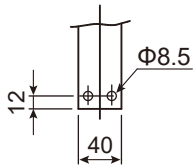

Mounting

Panel Cut

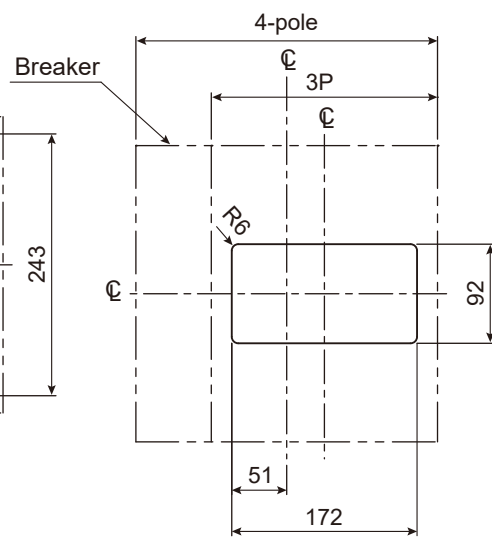
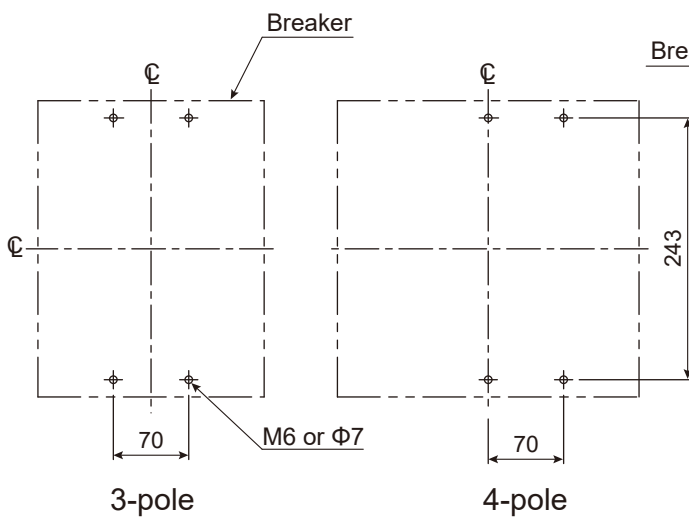

DIMENSION

BMA1000-HED/RED, BMA1250-HED/RED, BMA1600-HED/RED

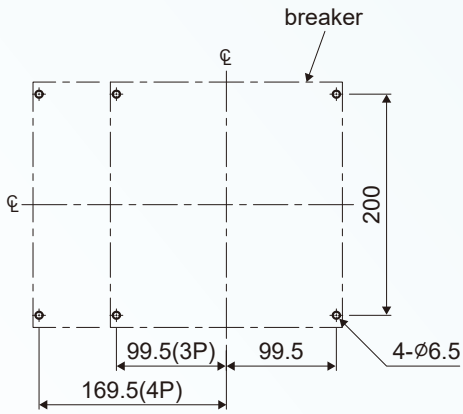
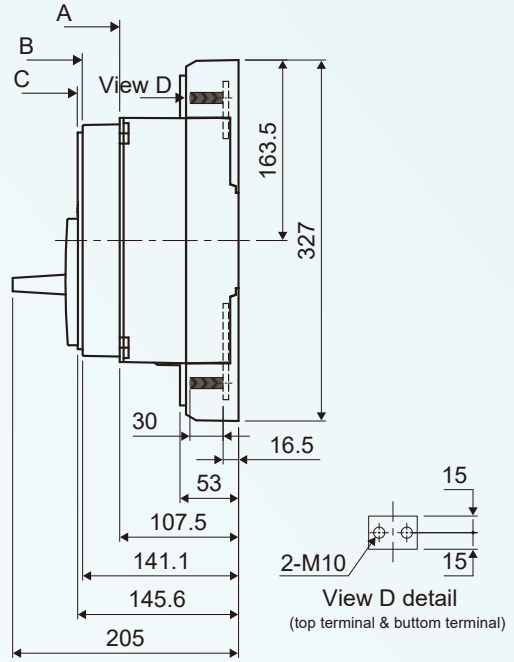
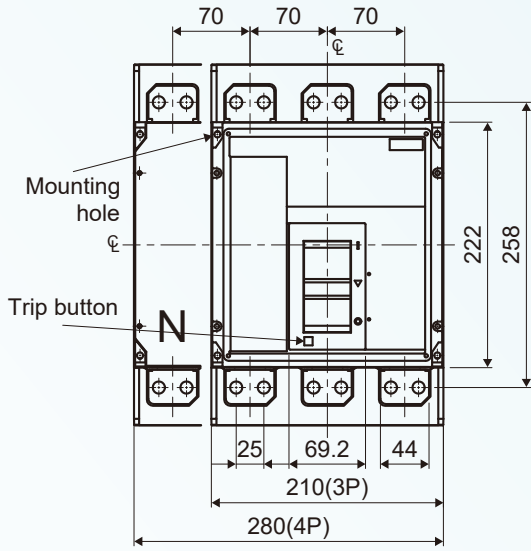

Panel drilling

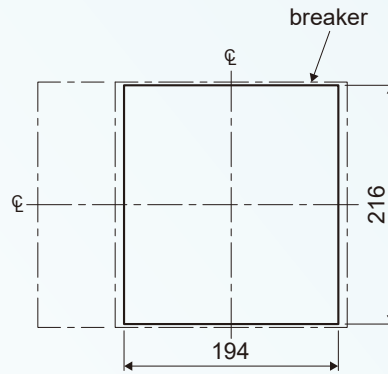

Panel dimension: A

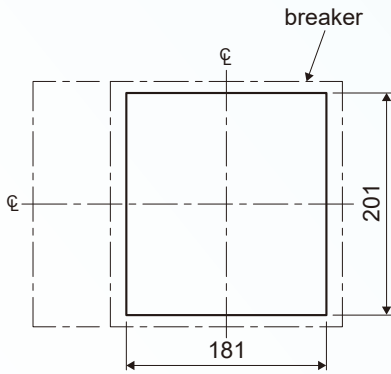

Panel dimension: B

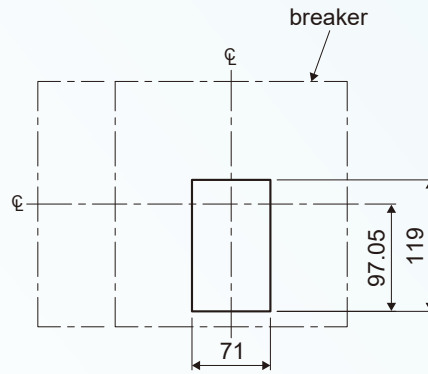

Panel dimension: C

BM

Series

BL

Series

ACC.

DIM.

Curve.

Other

Optional Accessories | Dimensions

Rotary Handle

Type	Poles	fig.1				fig.2			fig.3		
		A	B	C	D	E	F	G	H	J	K
EH-100N	3P, 4P	104	105	39	44	90	78	10	25	111	M4 or ø5
EH-100T	3P, 4P	104	105	39	44	90	78	10	25	111	
EH-100L	3P, 4P	104	105	39	44	90	78	10	35	126	
EH-125N	3P, 4P	104	105	39	44	90	78	10	30	132	
EH-250N	3P, 4P	104	105	39	44	90	78	10	35	126	
EH-250H	3P, 4P	104	125	39	44	90	78	10	35	126.5	
EH-400N	3P, 4P	150	173	60	77	108	112	10	44	194	
EH-800N	3P, 4P	150	173	60	77	108	112	10	70	243	

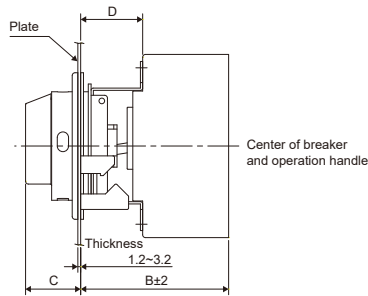
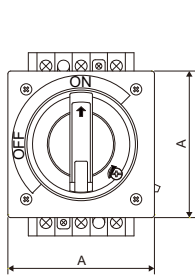
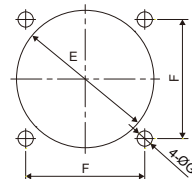
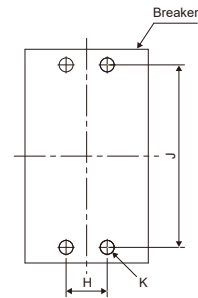

Fig. 1



Panel Dimension
Fig. 2



Breaker Dimension
Fig. 3

Note: 1. Optional for dust and water protection.

Extended Rotary Handle

Type	Dimensions (mm)					Screw
	A	B	C	D	Y	
MA-100N	111	25	125	229	+8	M4x80
MA-100T	111	25	125	229	0	M4x75
MA-100L	111	25	125	229	0	M4x75
MA-125N	114	30	125	229	+8	M4x80
MA-250N	126	35	125	229	0	ST3x10
MA-250H	126	35	143	247	0	M4x50
MA-400N	221	44	190	290	+10	M5x50
MA-800N	242	70	190	290	+10	M6x125 & M6x12

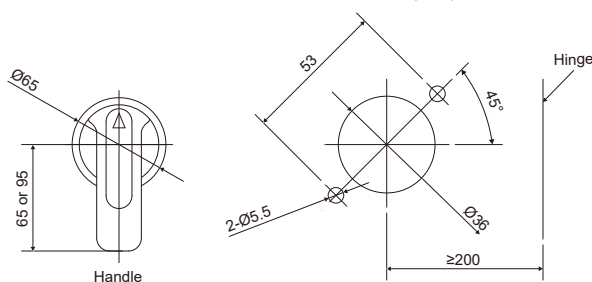
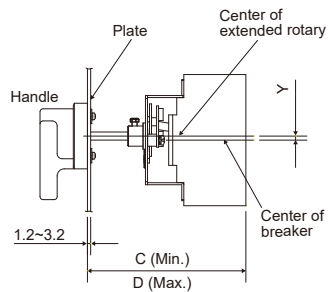
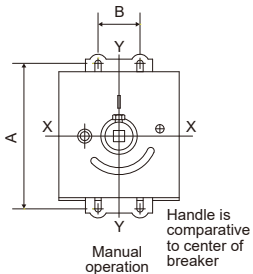

Motor Operation Device

Type	Dimensions (mm)						
	A	B	d	H	K	L	W
MT-100N	25	111	ø4.5	16.5	79	102	74
MT-125N	30	132	ø4.5	15	77	116	90
MT-250N	35	126	ø4.5	15	77	116	90
MT-250E	35	143.5	ø4.5	15	77	116	90
MT-400N	44	194	ø4.5	36	115	176	130
MT-800N	70	234	ø4.5	36	115	176	130

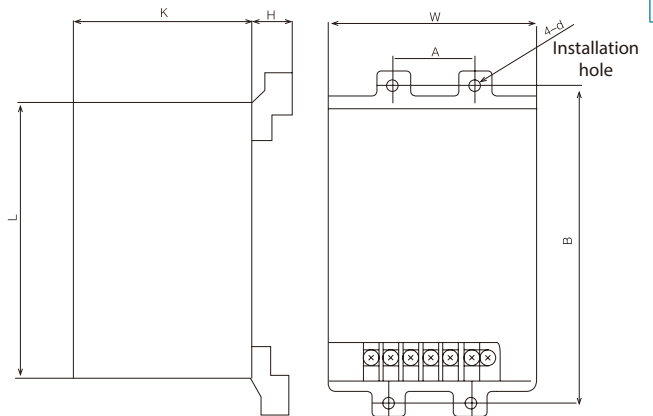

DIMENSION

BM

Series

BL

Series

ACC.

DIM.

Curve.

Other

■ Rear Connection

Type	Poles	Dimensions (mm)																Connect Direction			
		A	A1	B	B1	C	D	D1	E	F	G	H	H1	J	K	K1	K2	L	M	Horizontal	Vertical
PGI-100N	3	74	50	24	58	90	∅5	/	116	M10	9.5	28	12	M10	/	62	122	50	M4	⊙	⊙
	4	99	75															75			
PGI-125N	3	92	60	30	70	104	∅6	/	134	M10	13	26	16	M10	/	62	122	60	M5	⊙	⊙
	4	122	90															90			
PGI-250N	3	107	70	38	76	106	∅6	∅10	144	25	13	34	15	6	/	79	134	70	M5	⊙	⊙
	4	142	105															105			
PGI-400N	3	137	44	50	135	175	∅10	∅13	225	28	18	40	24	8	120	79	/	44	M8	⊙	⊙
	4	181	88															88			
PGI-800N	3	212	140	57	143	185	∅10	∅13	243	44	17	53	20	11	/	146	/	140	M8	⊙	⊙
	4	282	210															210			

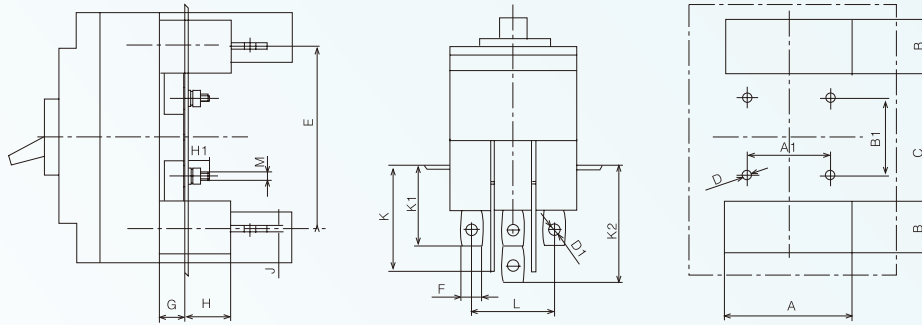

■ Rear Connection

Type	Poles	Dimensions (mm)																Connect Direction			
		A	A1	B	B1	C	D	D1	E	F	G	H	H1	J	K	K1	K2	L	M	Horizontal	Vertical
PGI-BM250	3	107	70	38	76	106	∅6	∅10	144	25	13	34	15	6	/	79	134	70	M5	⊙	⊙

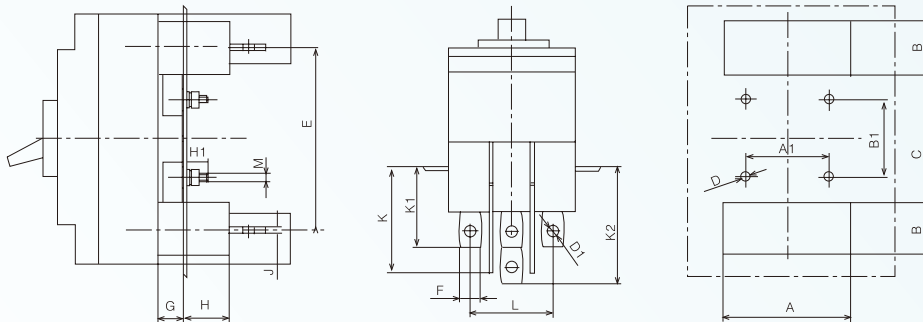

■ Locking Device

Dimensions

(1)FHL-250M

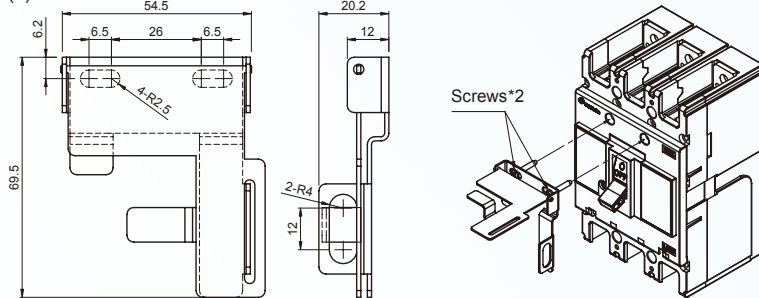

(2)FHL-400/800M

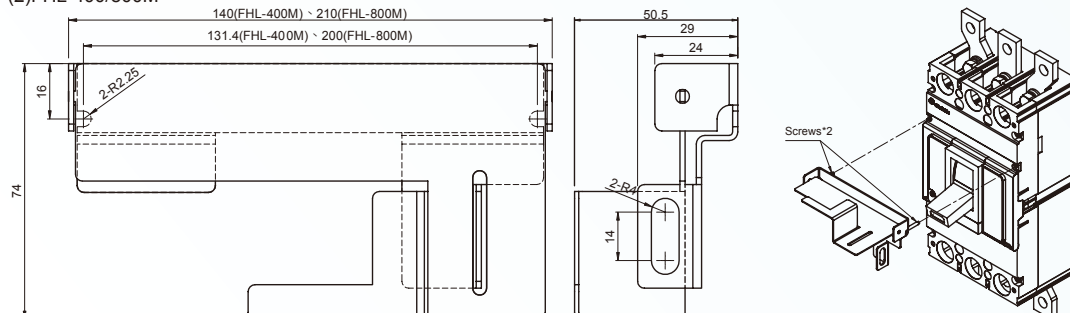

Tripping Characteristic Curve

BM30-CN

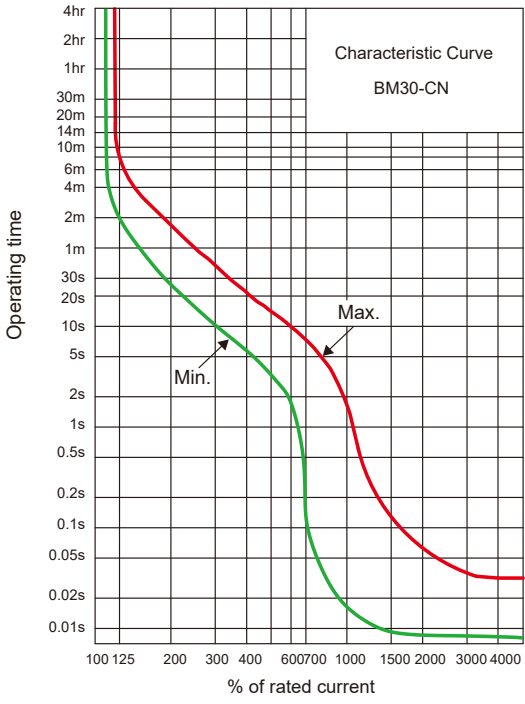

Compensation Curve

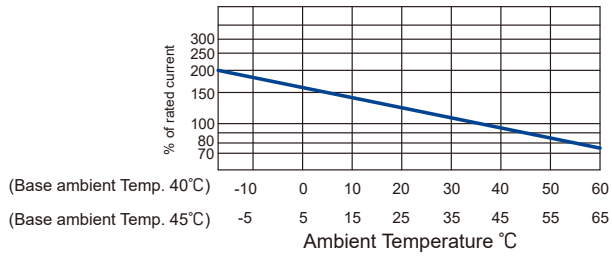

BM30-SN

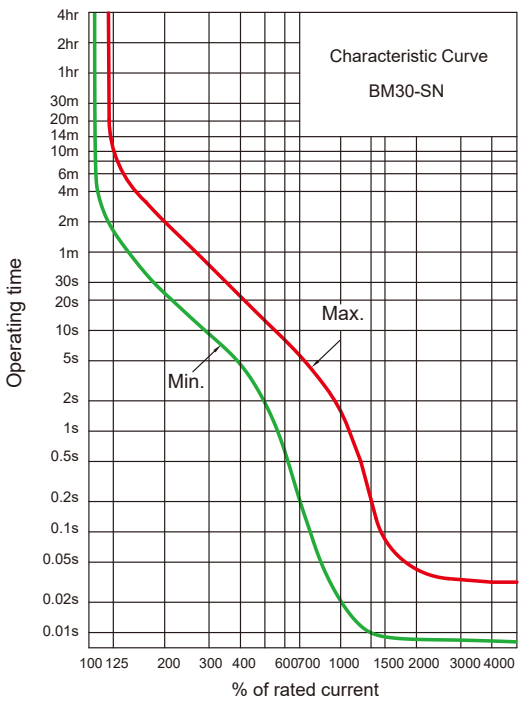

Compensation Curve

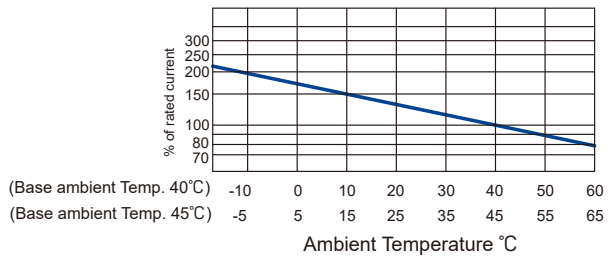

Tripping Characteristic Curve

BM50-CN BM100-MN

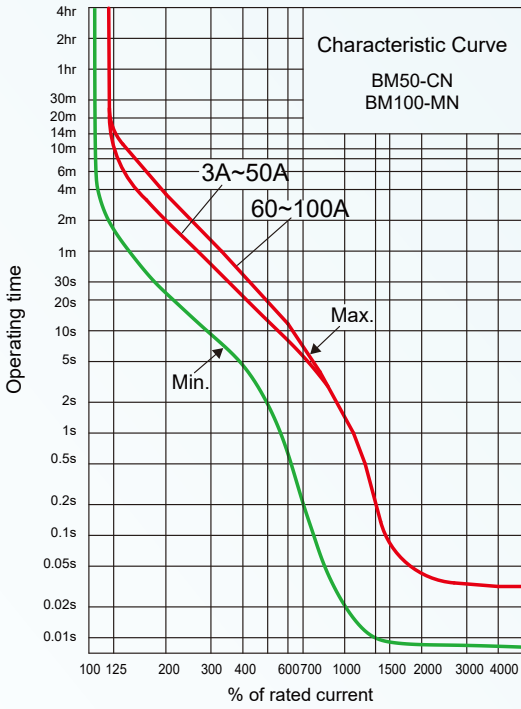

Compensation Curve

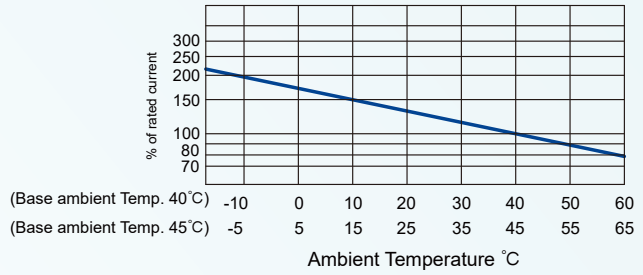

BM60-SN、BM60-HN、BM63-SN、BM63-HN、BL50-SN

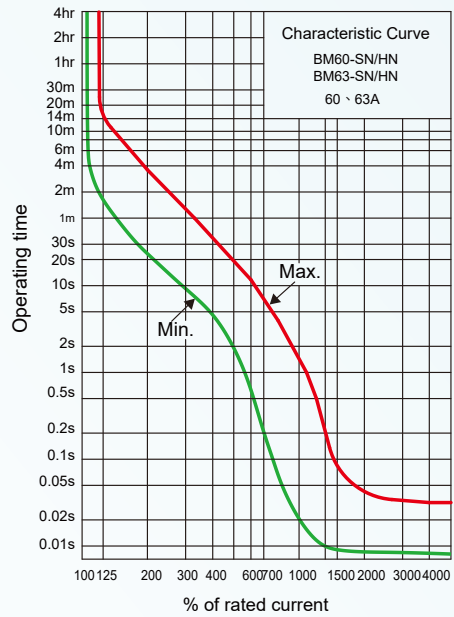
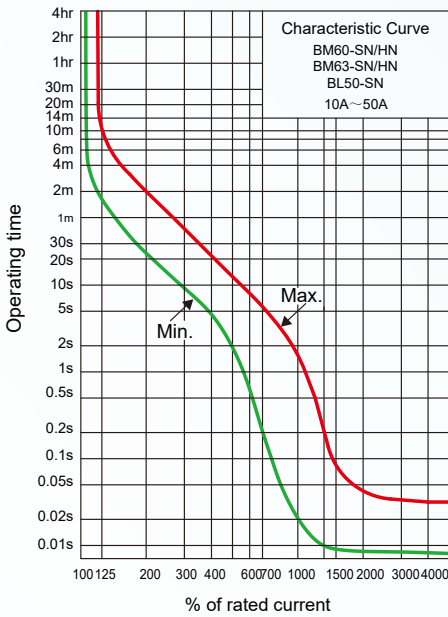

Compensation Curve

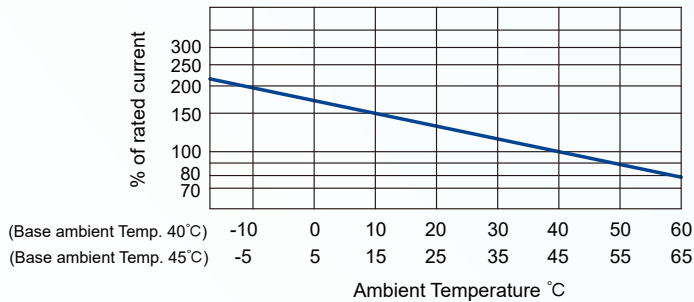

Tripping Characteristic Curve

BM100-SN

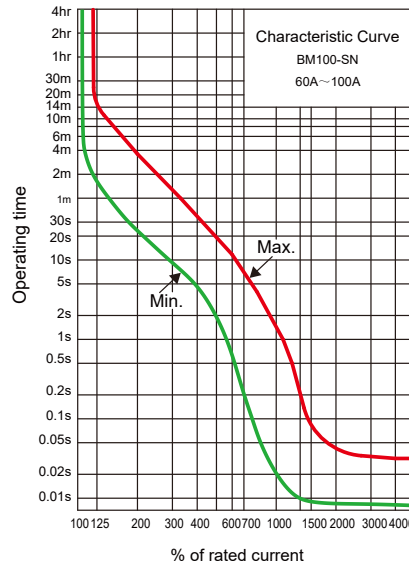
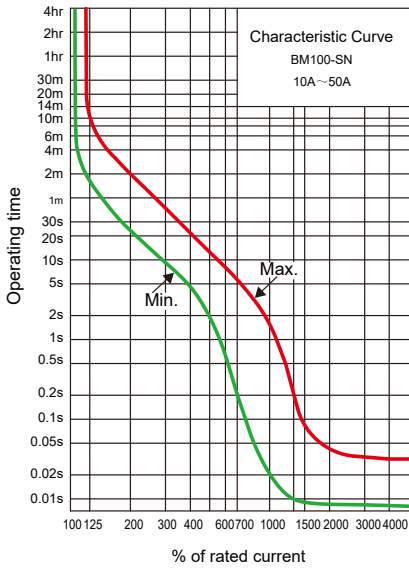

Compensation Curve

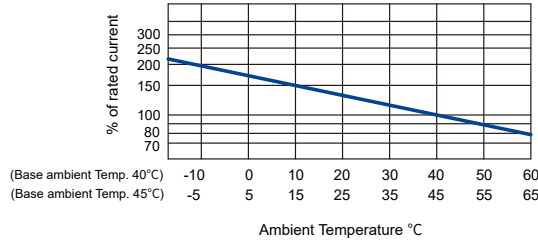

BM60-HBN、BM100-HN、BL100-SN/HN

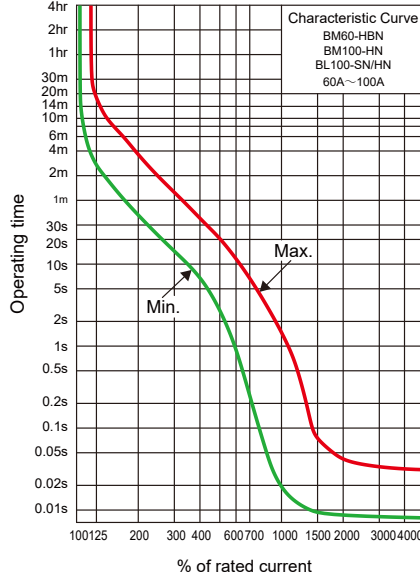
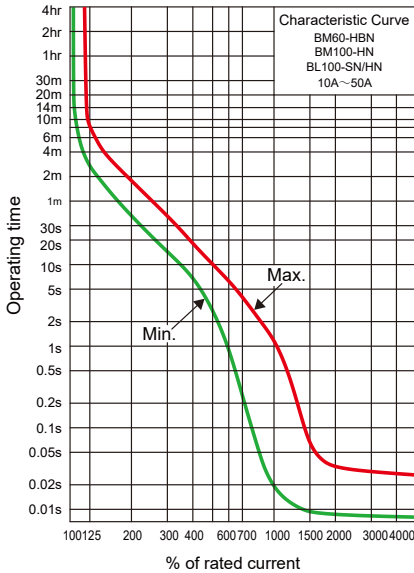

Compensation Curve

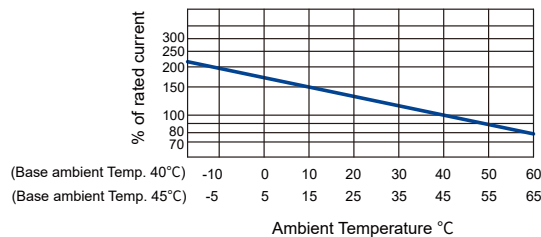

Tripping Characteristic Curve

BM100-HS

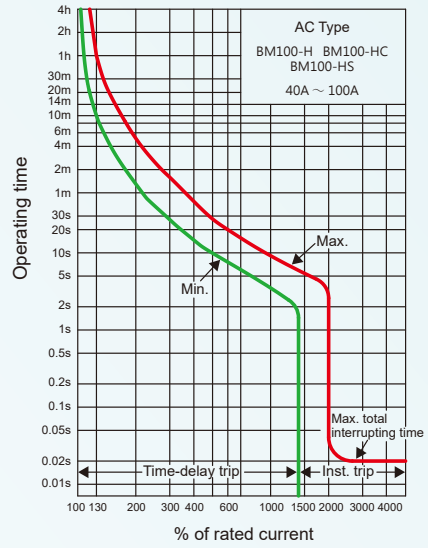
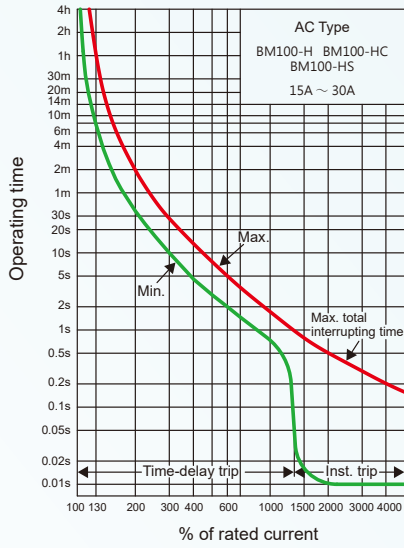

Compensation Curve

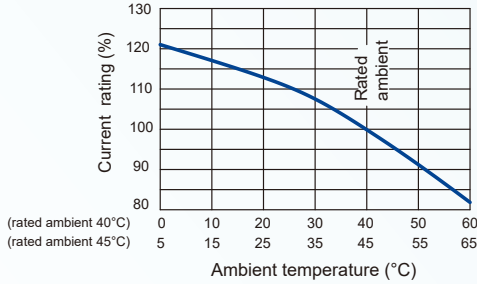

Compensation Curve

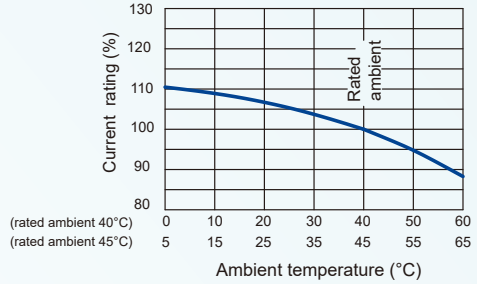

BM125-SN/HN

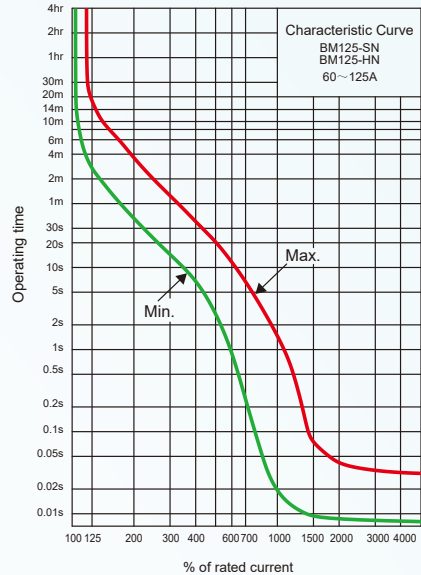
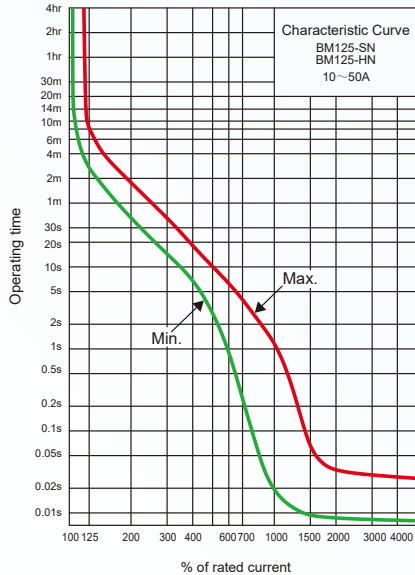

Compensation Curve

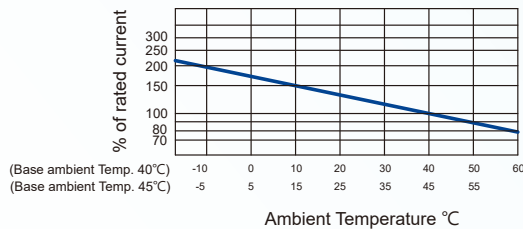

Tripping Characteristic Curve

BM100-BTD/STD

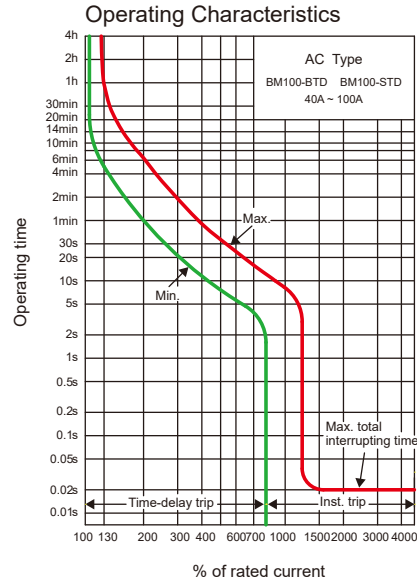
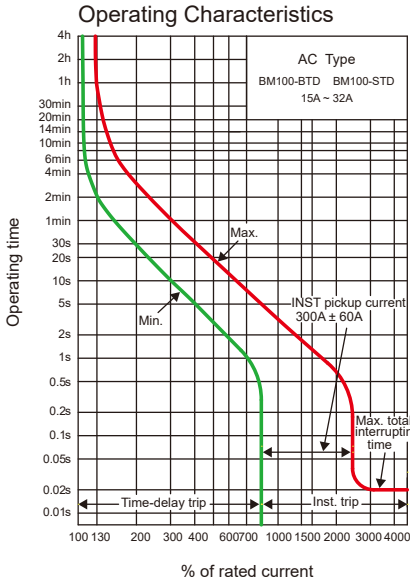

Compensation Curve

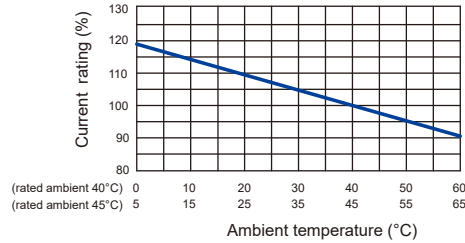

BM100-LTD, BM125-LTD

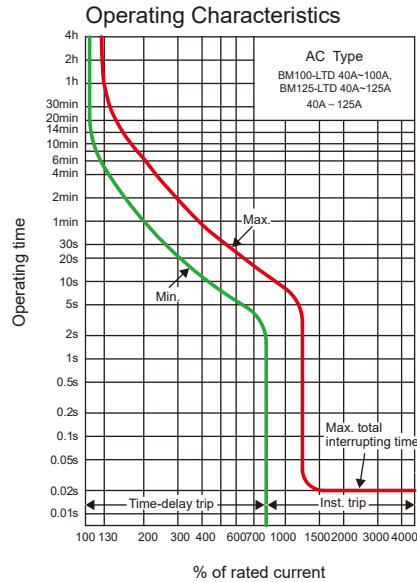
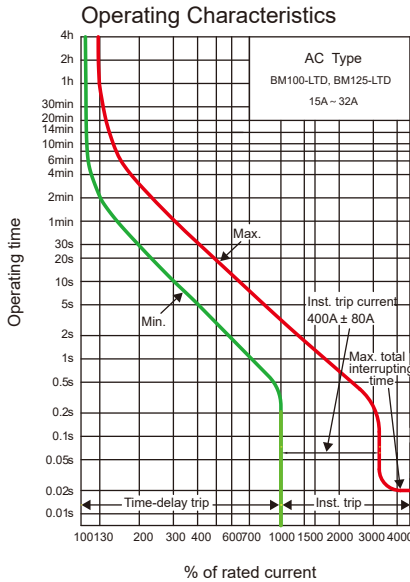

Compensation Curve

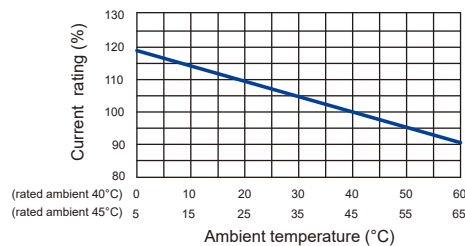

Tripping Characteristic Curve

BM125-HTA/RTA

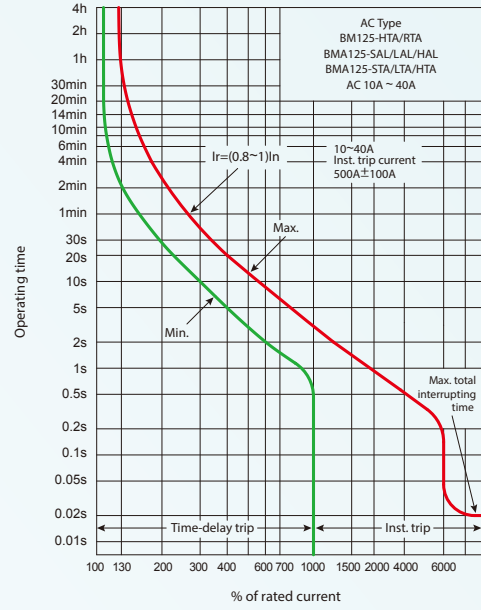
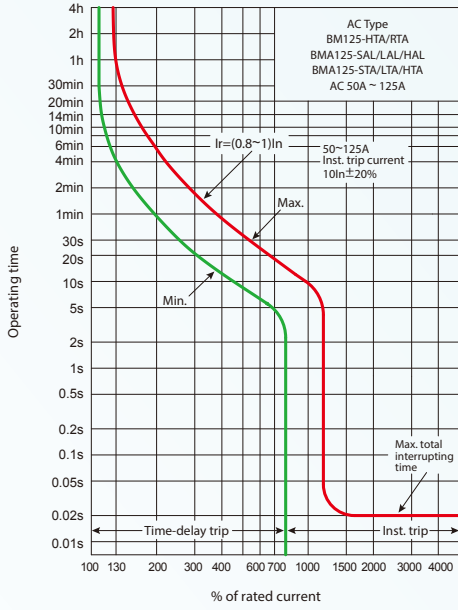

Compensation Curve

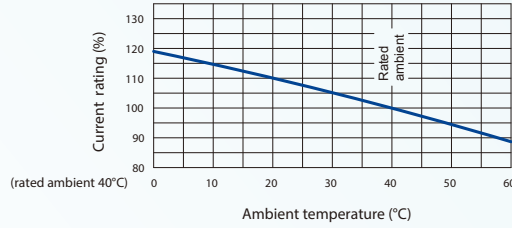

BM160-HS、BM250-HS

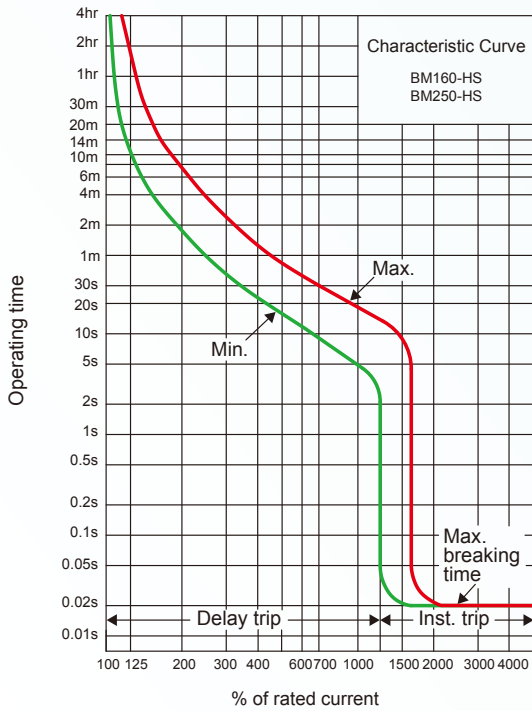

Compensation Curve

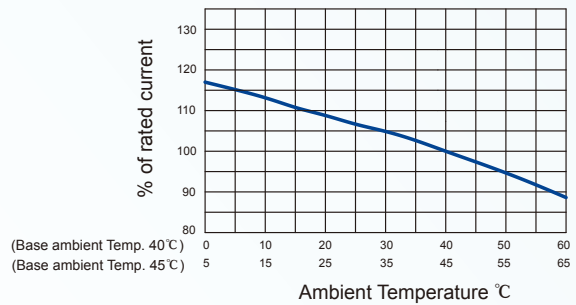

Tripping Characteristic Curve

BM100-FTD

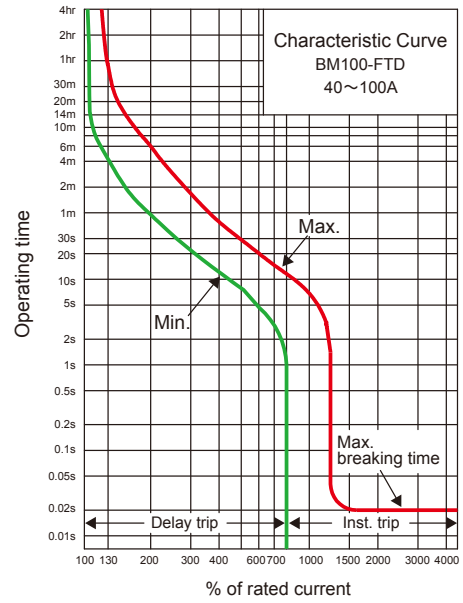
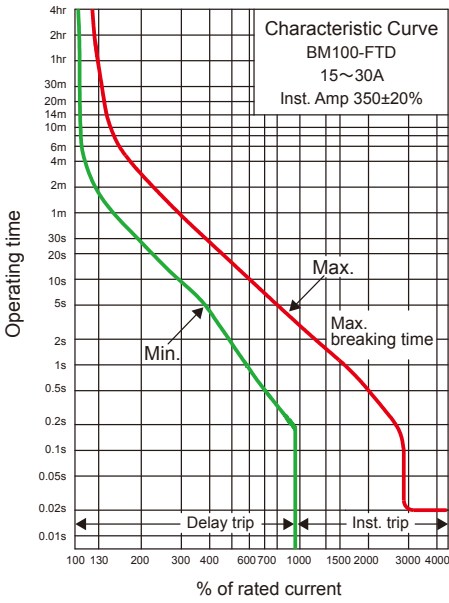

Compensation Curve

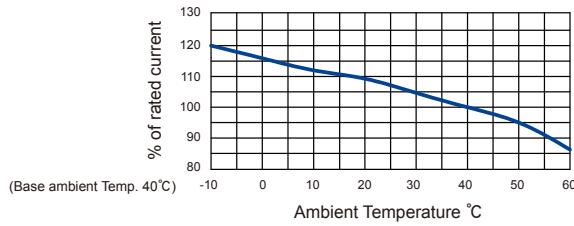

BM(BL)160-SN/HN、BM(BL)250-CN/SN/HN

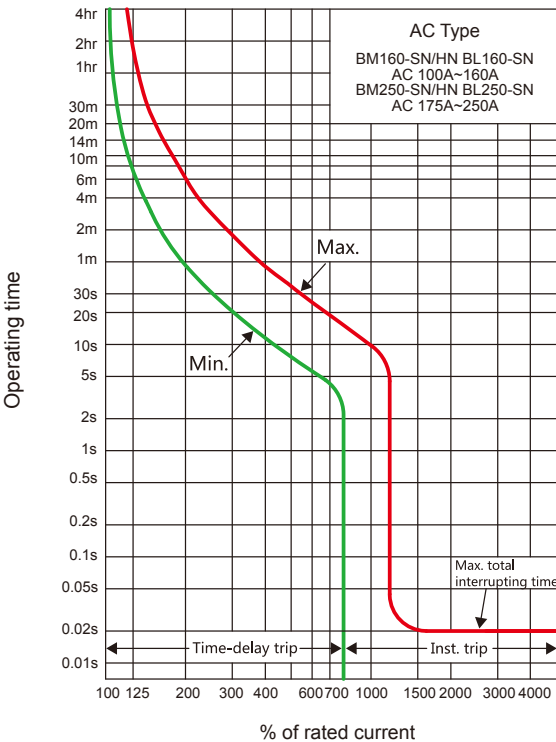

Compensation Curve

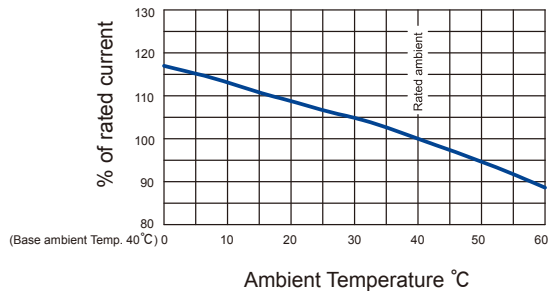

Tripping Characteristic Curve

BM160/250-HTA/RTA

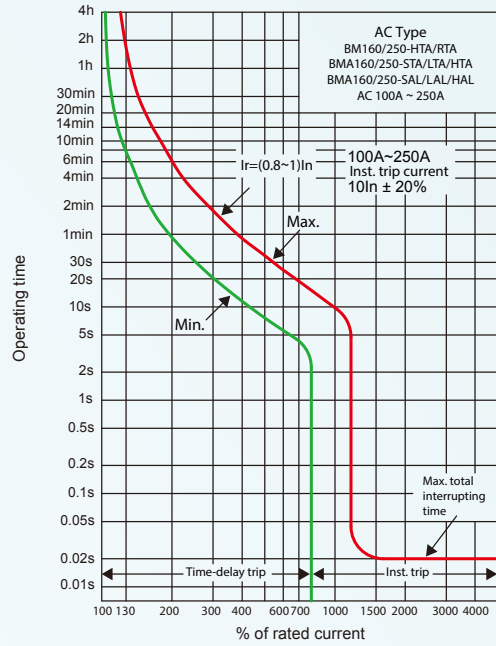
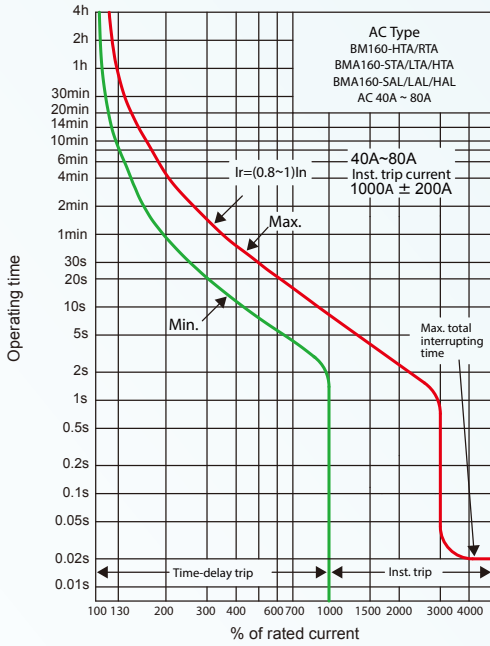

Compensation Curve

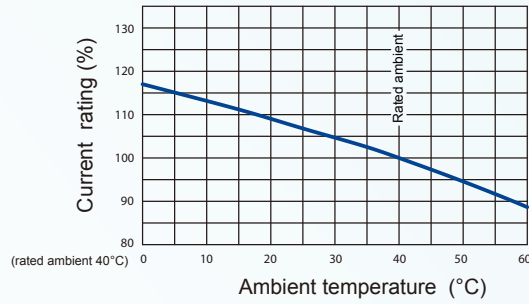

BM(BL)400-CN/SN/HN/RN/UN

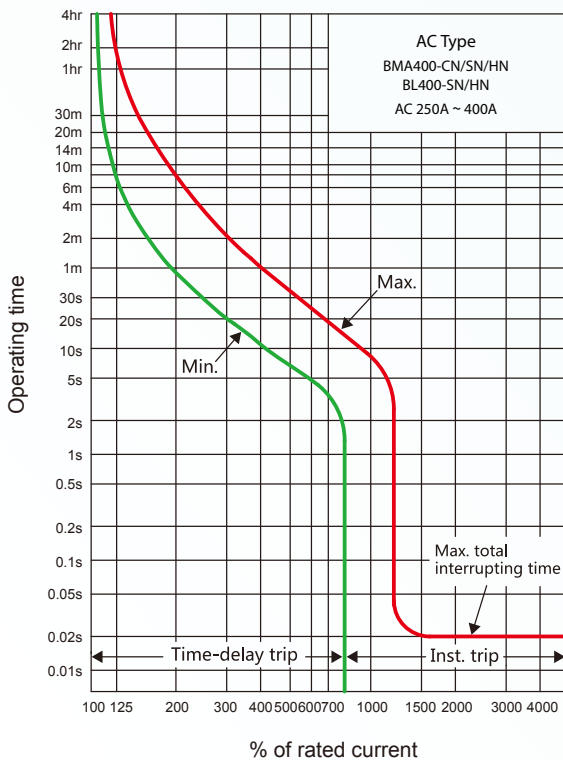

Compensation Curve

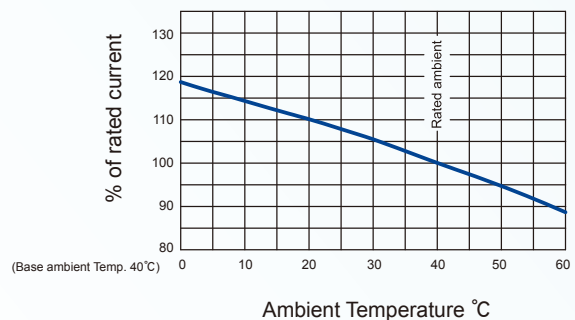

Tripping Characteristic Curve

BM630s-STD/LTD/HTD/RTD/STA/LTA/HTA/RTA

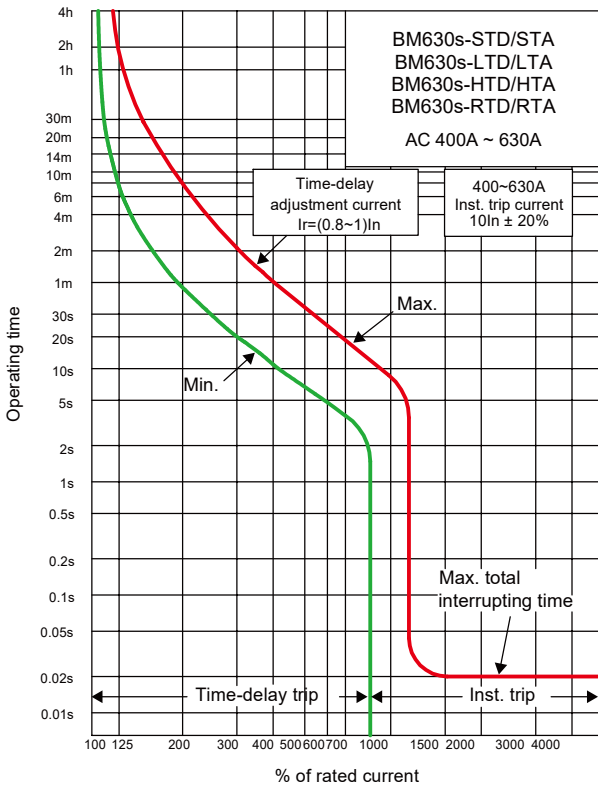

Compensation Curve

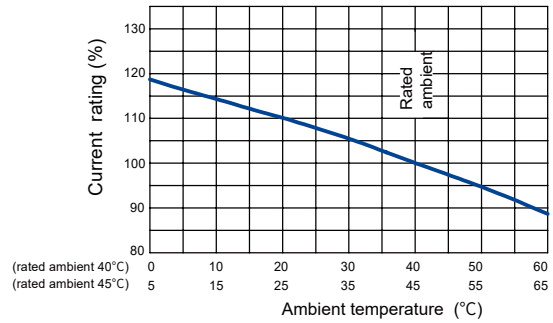

BM(BL)630-CN/SN/HN/RN/UN

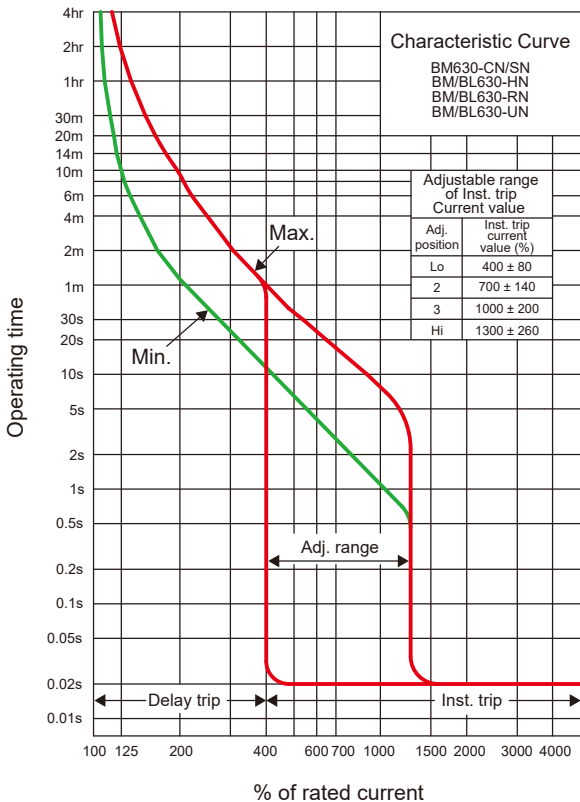

Compensation Curve

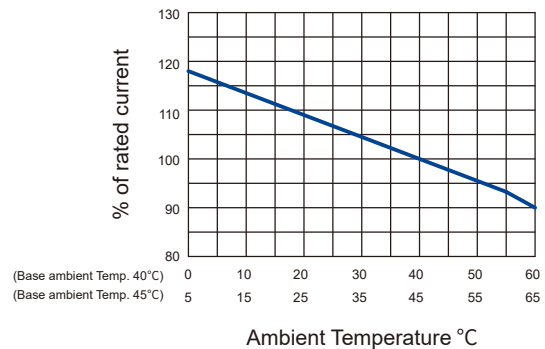

- BM Series
- BL Series
- ACC.
- DIM.
- Curve.
- Other

Tripping Characteristic Curve

BM(BL)800-CN/SN/HN/RN

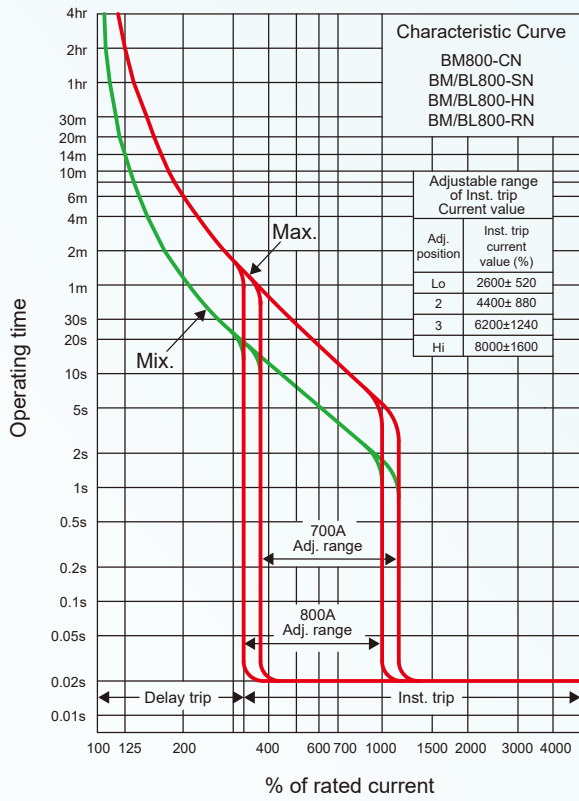

Compensation Curve

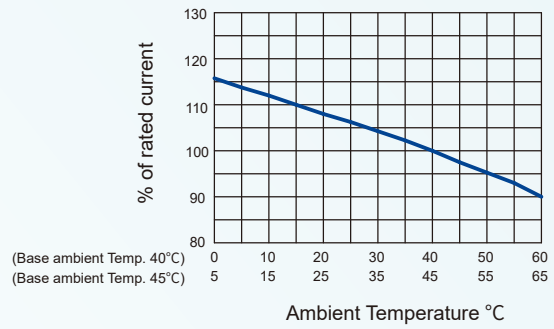

BM1000-HS · BM1200-HS

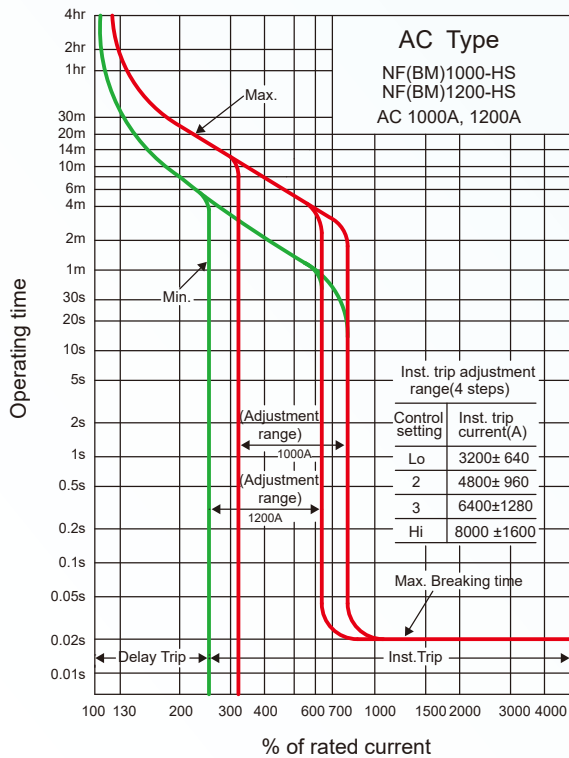

Compensation Curve

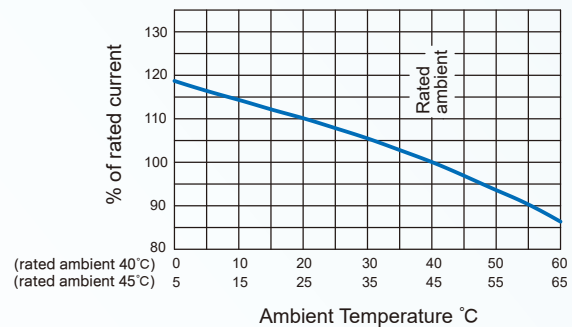

Tripping Characteristic Curve

BM1600-HS

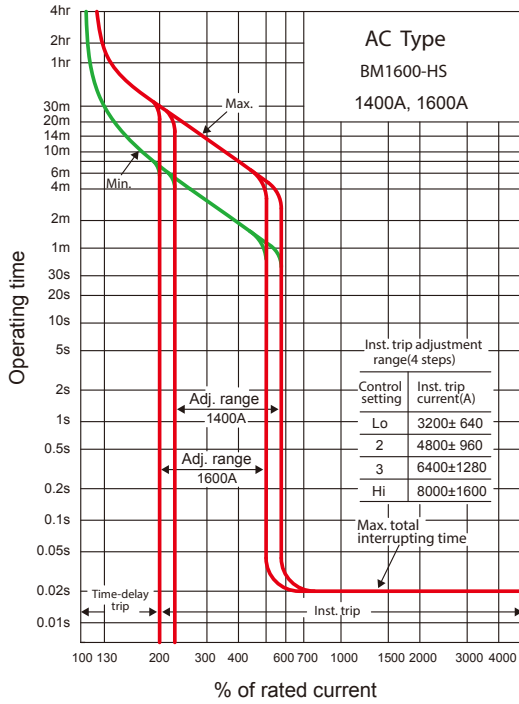

Compensation Curve

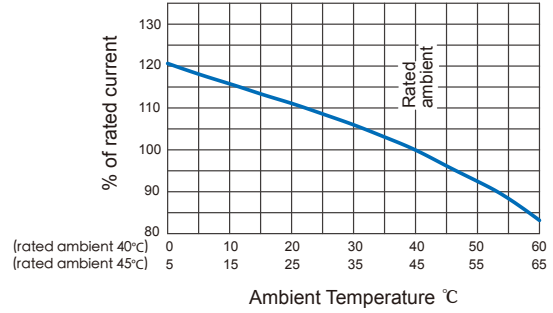

BMA125-STA/LTA/HTA

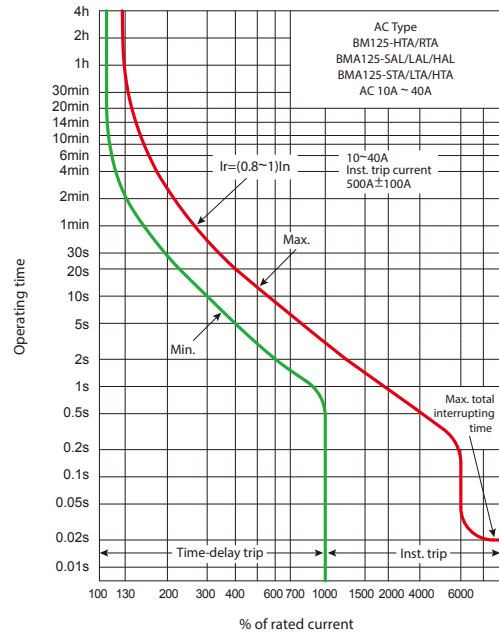
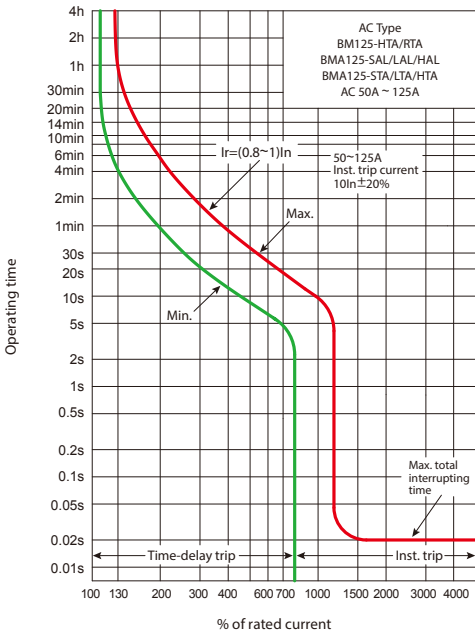

Compensation Curve

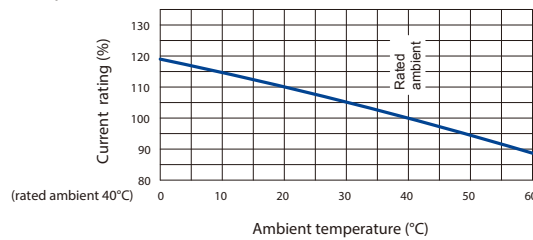

Tripping Characteristic Curve

BMA160-STA/LTA/HTA, BMA250-STA/LTA/HTA

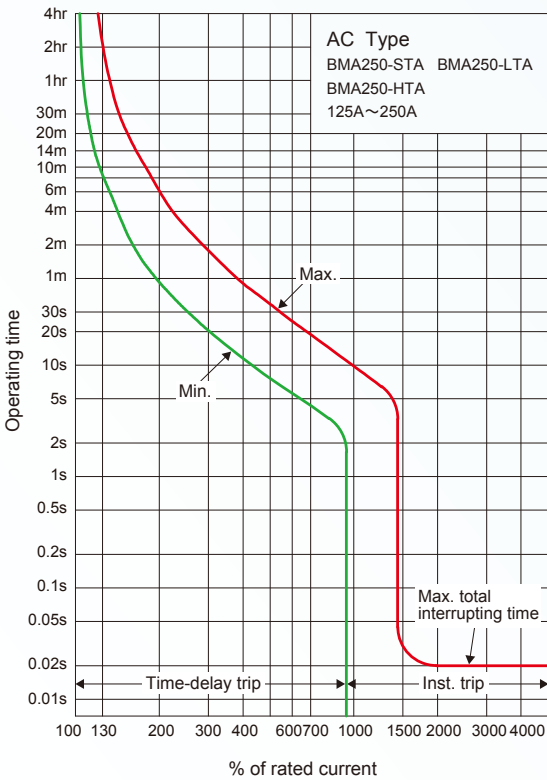
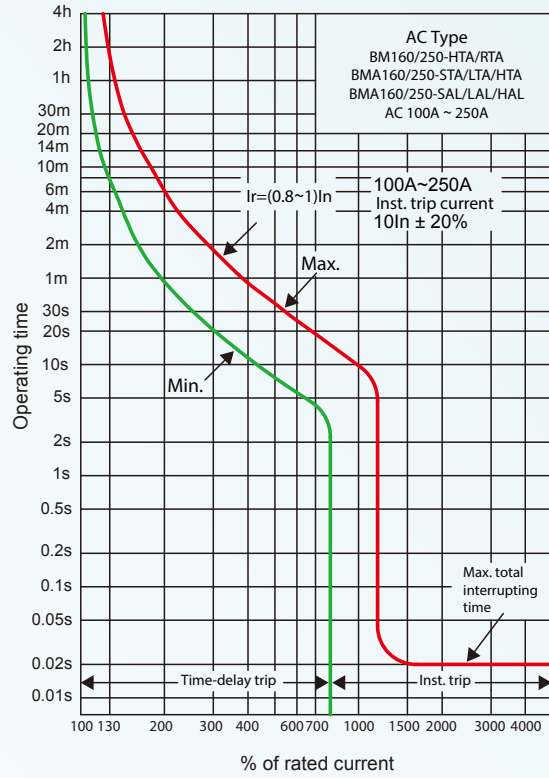
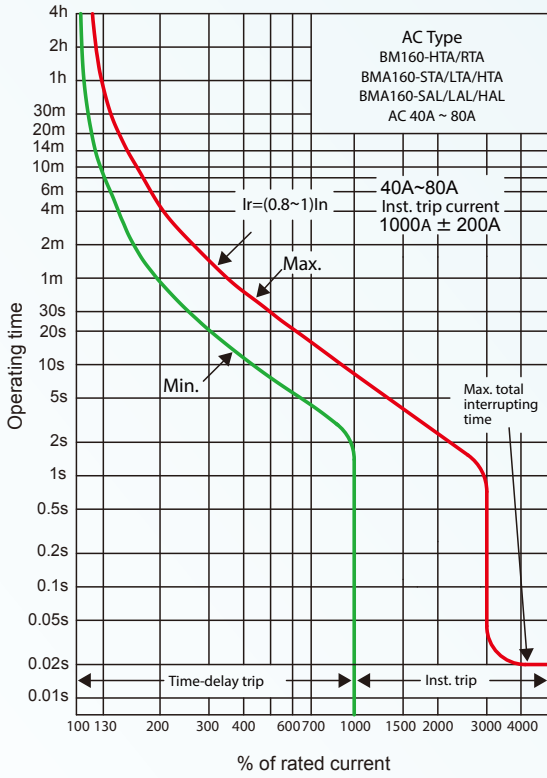

Compensation Curve

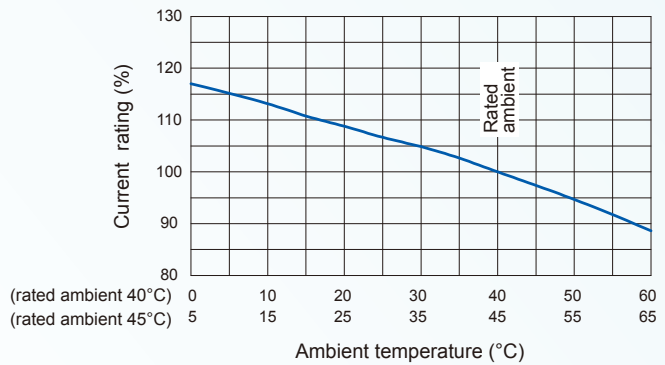

Tripping Characteristic Curve

BMA400-LTA/HTA/RTA

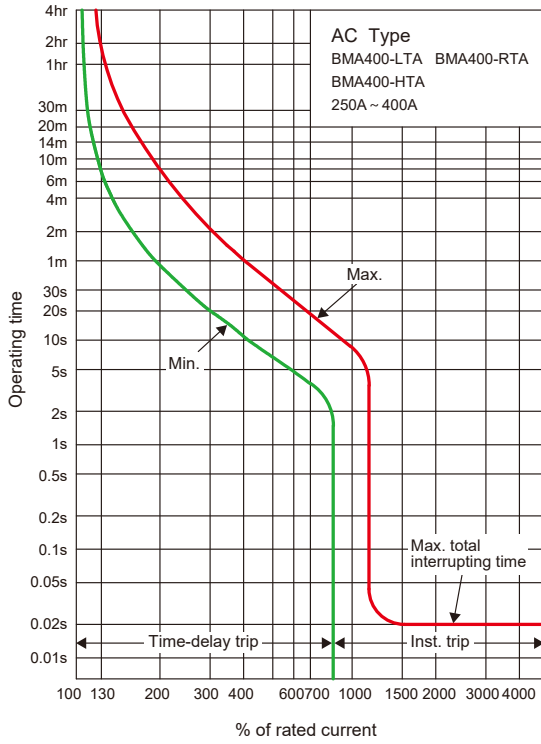

Compensation Curve

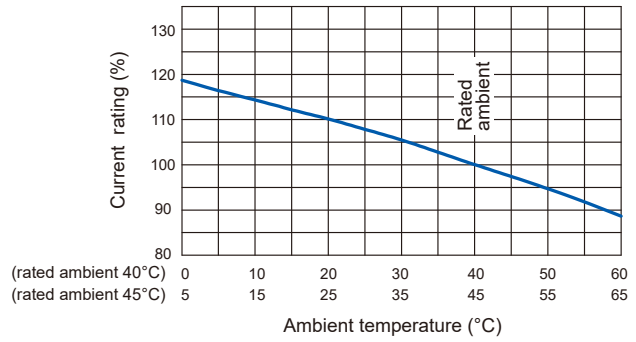

BMA630s-STD/LTD/HTD/RTD/STA/LTA/HTA/RTA

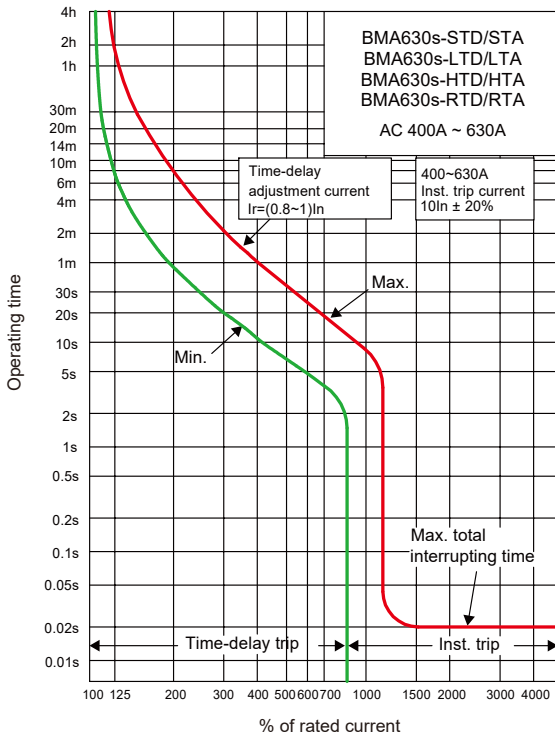

Compensation Curve

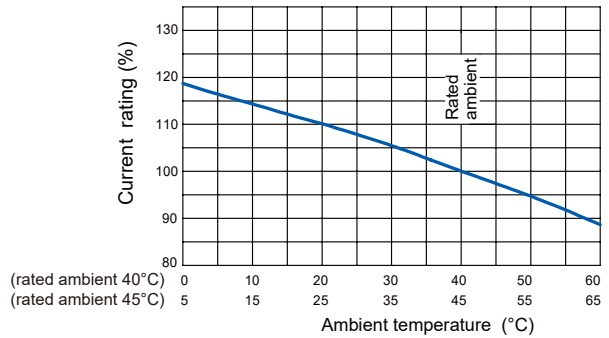

Tripping Characteristic Curve

BMA630-HTD/RTD/HTA/RTA

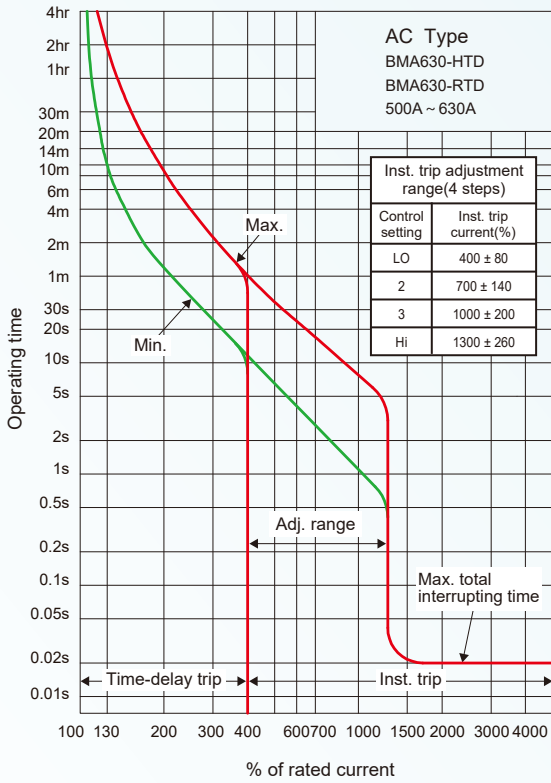

Compensation Curve

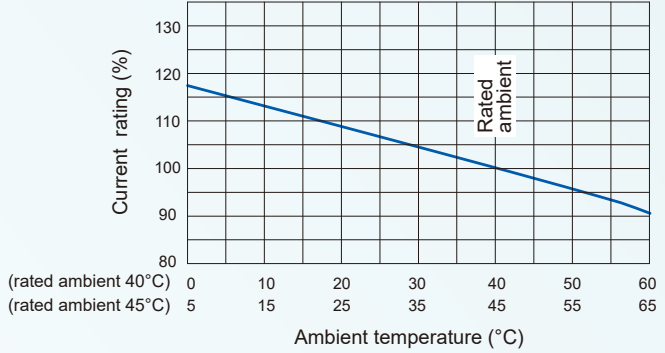

BMA800-HTD/RTD/HTA/RTA

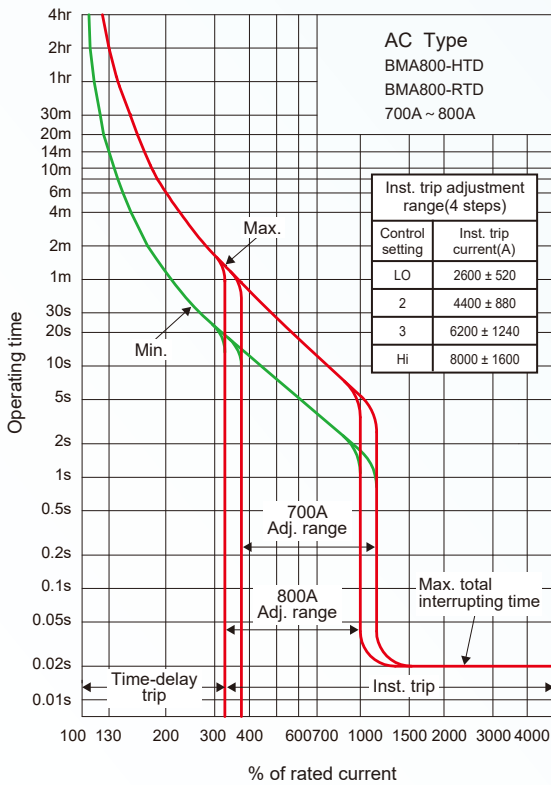

Compensation Curve

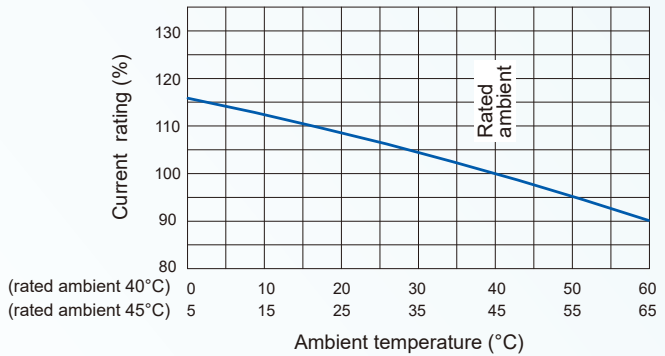

Tripping Characteristic Curve

BMA630-HED/RED, BMA800-HED/RED

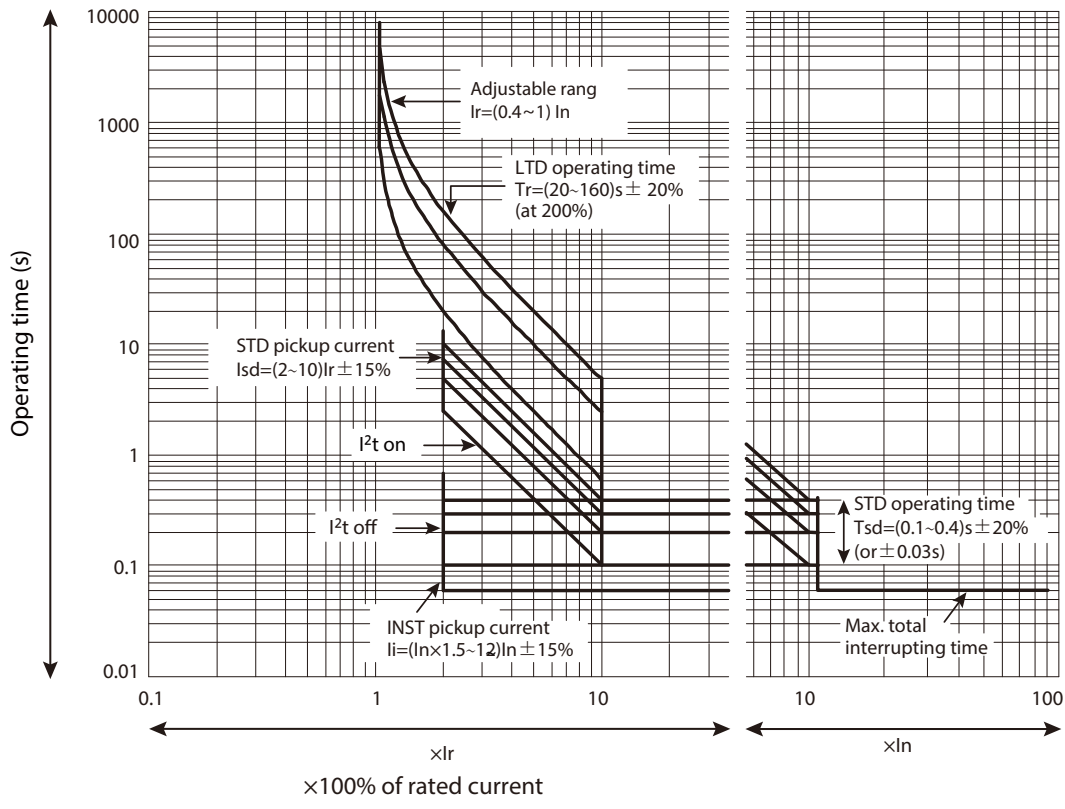

BMA1000-HED/RED, BMA1250-HED/RED, BMA1600-HED/RED

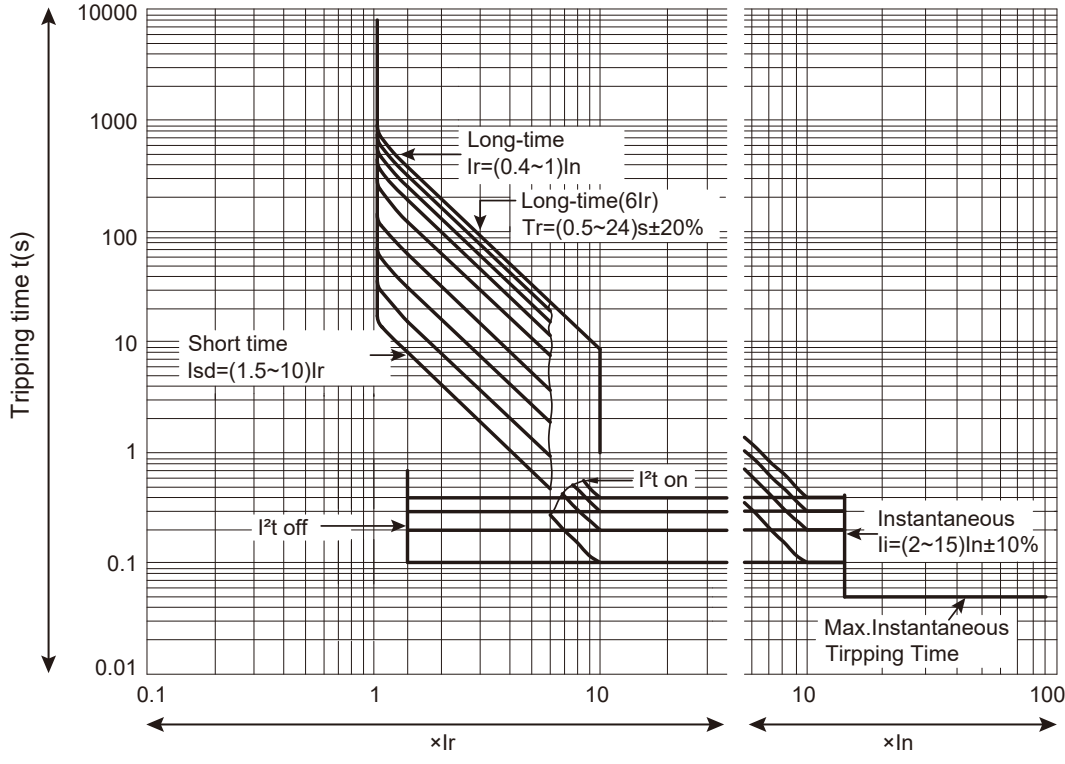

Wiring Example

■ ELCB Wiring Diagram

○ Correct ✕ Incorrect

1P

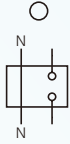

2P

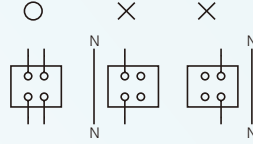

3P

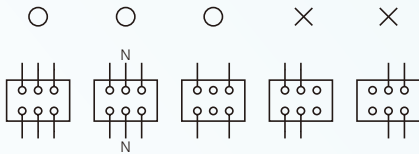

4P

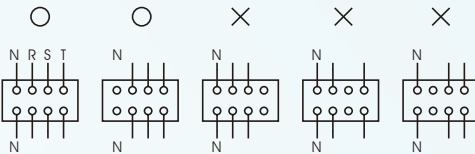

BM

Series

BL

Series

ACC.

DIM.

Curve.

Other

■ Power Circuit System

1 Phase 2 Wire
110V - 220V

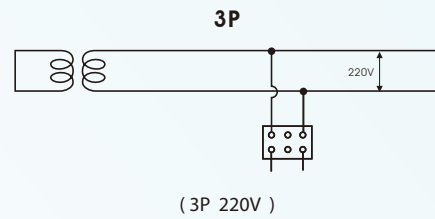
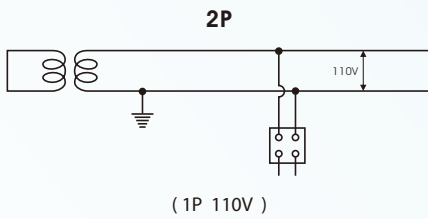

1 Phase 3 Wire
110V - 220V

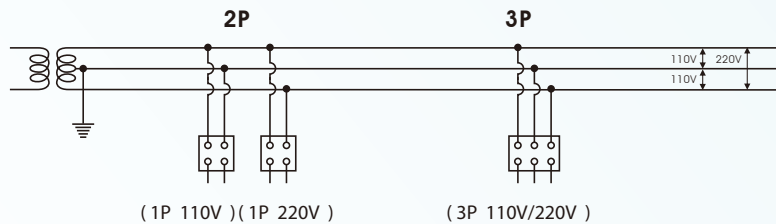

3 Phase 4 Wire
220V - 380V

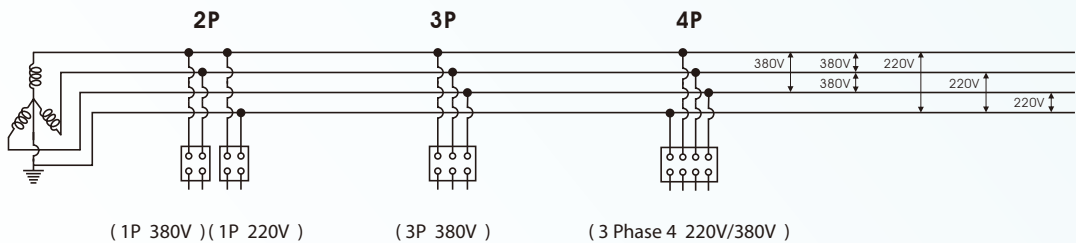

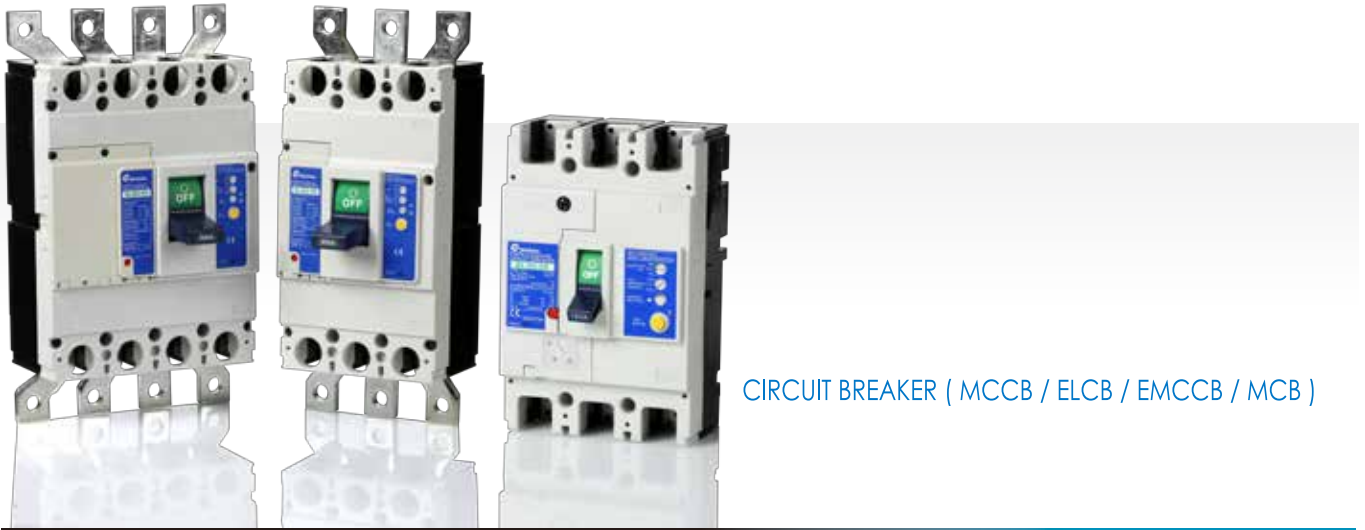

CIRCUIT BREAKER (MCCB / ELCB / EMCCB / MCB)

Breaker & Switchgear System



AIR CIRCUIT BREAKER

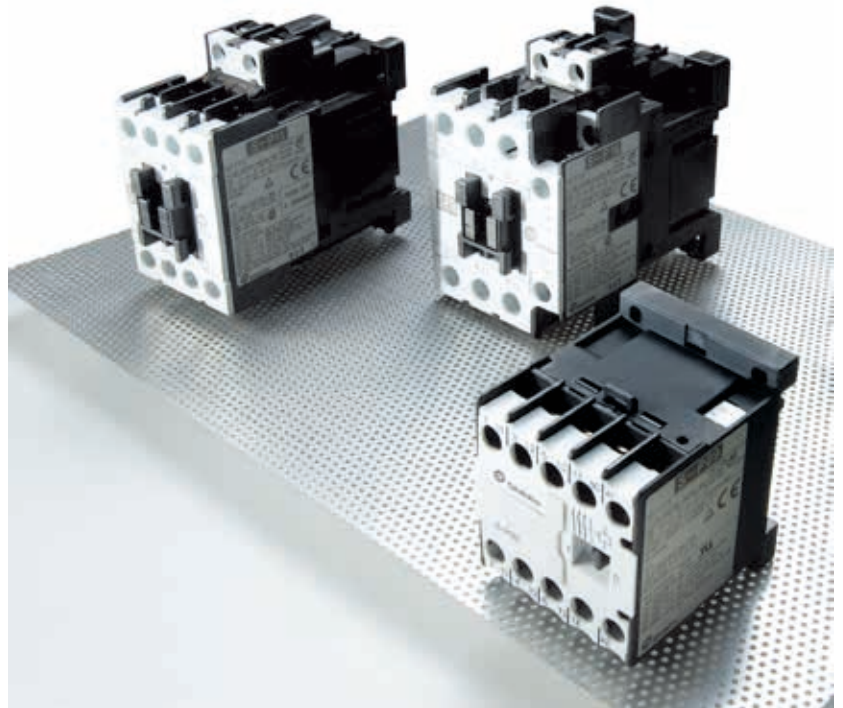

MAGNETIC CONTACTOR / SWITCH (CONTACTOR / MS / MMS)



AUTOMATIC TRANSFER SWITCHES



SURGE PROTECTIVE DEVICE



SMART METER



INVERTER



LOW VOLTAGE POWER CAPACITORS

SHIHLIN ELECTRIC & ENGINEERING

MOTOR CONTROL (CONTACTOR/ MS/ MMS), CIRCUIT BREAKER (MCCB/ ELCB/ EMCCB/ MCB), AIR CIRCUIT BREAKER, AUTOMATIC TRANSFER SWITCHES (Panel Board Type/ Residential Unit Use), SURGE PROTECTIVE DEVICE, LOW VOLTAGE POWER CAPACITORS, SMART METER, INVERTER

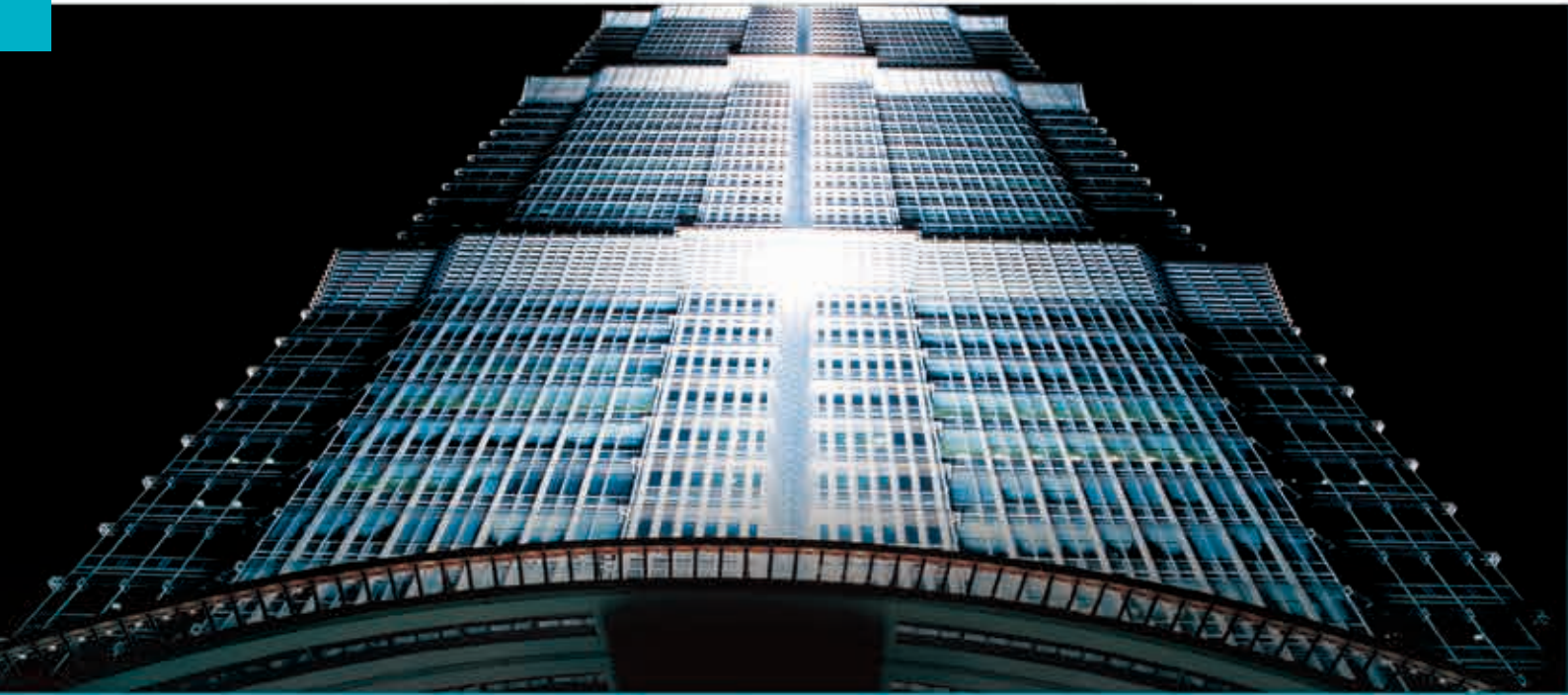

Breaker & switchgears overseas sales dept.

3F, No.9, Sec. 1, Chang-an E. Rd., Zhongshan Dist., Taipei City 10441, Taiwan

T. +886-2-2541-9822 F. +886-2-2581-2665

e-mail. b.export@seec.com.tw

<http://circuit-breaker.seec.com.tw>

Headquarters

16F, No.88, Sec. 6, Zhongshan N. Rd., Shilin Dist., Taipei City 11155, Taiwan

T. +886-2-2834-2662 F. +886-2-2836-6187

<http://www.seec.com.tw>

Distributor

B230612E.MCCB-OB